

<http://bit.ly/IOT-MIT>

Review [“Healthcare”](#) PDF

# Medical IoT

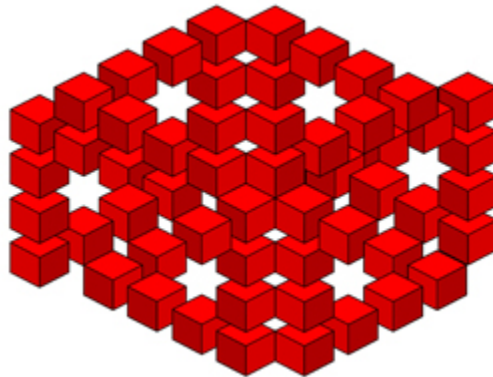

Dr Shoumen Palit Austin Datta

MIT Auto-ID Labs and Research Affiliate, Department of Mechanical Engineering, Massachusetts Institute of Technology • [shoumen@mit.edu](mailto:shoumen@mit.edu)

Senior Scientist, MD PnP Lab, Medical Device Interoperability, Massachusetts General Hospital, Harvard Medical School • [www.mdppnp.org](http://www.mdppnp.org)

This is a connected series of presentations which discusses the following topics. It is divided into segments simply for the sake of convenience. It may be better if reviewed as a continuum.

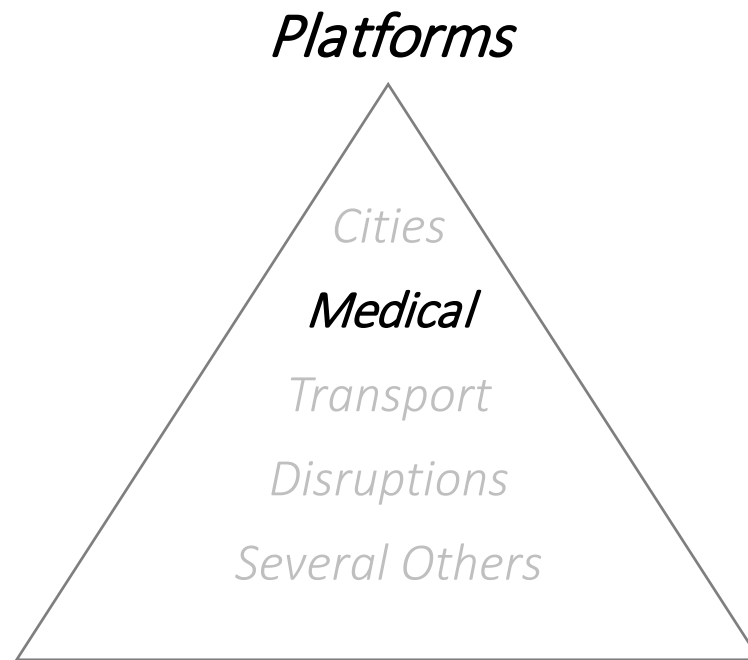

Dr Shoumen Palit Austin Datta

MIT Auto-ID Labs and Research Affiliate, Department of Mechanical Engineering, Massachusetts Institute of Technology • [shoumen@mit.edu](mailto:shoumen@mit.edu)

Senior Scientist, MD PnP Lab, Medical Device Interoperability, Massachusetts General Hospital, Harvard Medical School • [www.mdnp.org](http://www.mdnp.org)

*Platforms are indivisible but better understood if discussed as*

Platform as a Principle = Information

Platform as a Practice = Connectivity

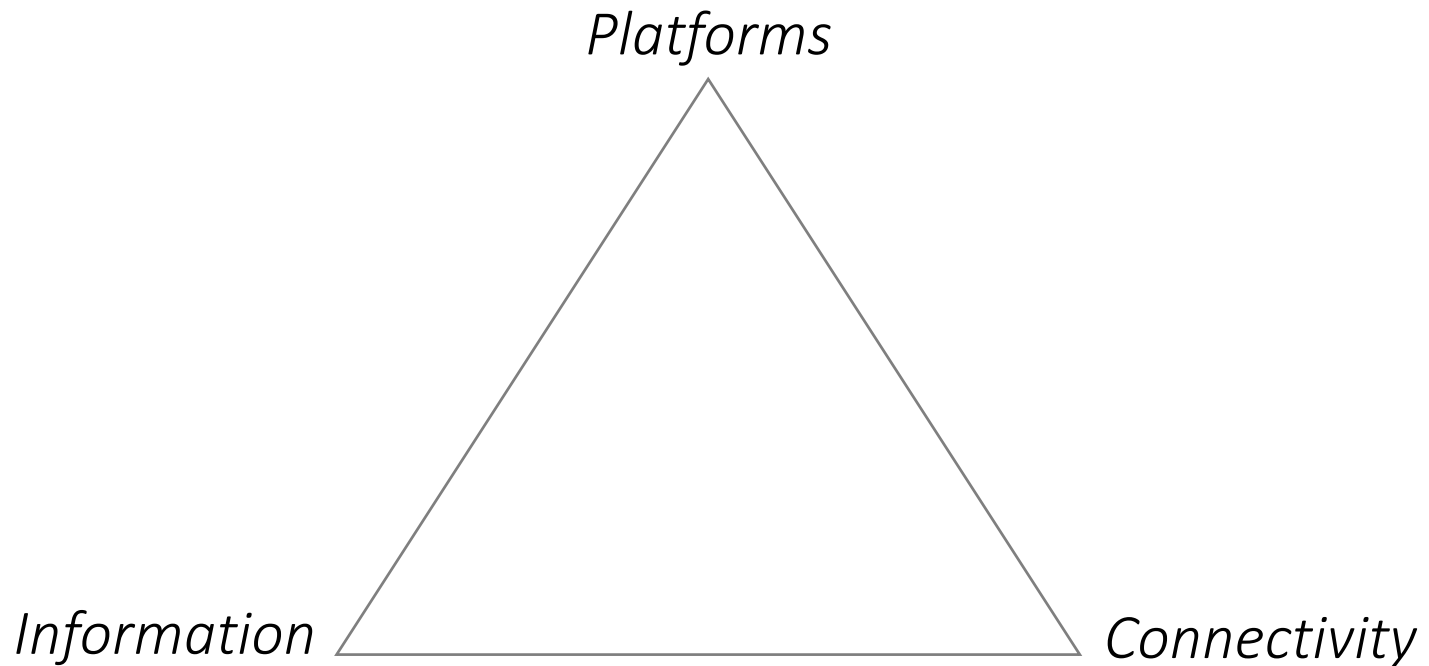

# Information

The Information Age is not over. It started with the Big Bang which created the Solar System and it may persist *ad infinitum* as long as the Solar System continues its physical existence. It is the mother of all platforms and the most fundamental fabric of connectivity. Our understanding of the difference between hydrogen and oxygen is based on information. The difference between bauxite and the material of the Coke can is information. Information is the differentiator between Apple Newton which died prematurely vs the almost identical Palm Pilot that once climbed the luminous summit. Information changes when the car you are driving is suddenly crushed in a collision with a truck. Think about the [approximately 500 inhabitants](#) of Mureybet, Syria in 8000BC and compare their information content to the approximately 1500 modern day inhabitants of Dingle village in County Kerry (Ireland) which boasts of at least 50 pubs in this miniscule hamlet near the Atlantic. Information has grown. Described by Claude Shannon in 1948 as informational entropy, it has been [shown](#) that the interpretation of entropy (formula) provided by Ludwig Boltzmann (the Boltzmann equation) becomes the Shannon equation, thus mathematically linking entropy and information.

# Connectivity

Is it a new theme? Isn't it fundamentally pervasive in every entity – physical, metaphysical and cyberphysical? Doesn't it transcend the sub-nano realm and the super-macro domain? Doesn't it define the astronomical universe, all biological systems and everything conceptual in between? The mobility of ancient civilizations to explore new worlds were physical connections between atoms. The bargain hunter's app to compare prices between various retailers is the new sense of value which connects bits with atoms. All things and processes are about connectivity. Invention and innovation was, is and will be about connecting the dots, real and/or virtual, perceived and/or imagined. Human thought, technological progress and the future of synaptic neuromorphic quantum dots are manifestations of connectivity, convergence and confluence of concepts. The sense of connectivity is germane to life. Its ubiquity makes us oblivious to its quintessential nature. To evoke the central theme of connectivity, therefore, is not an insight but rather recognizing the fabric of the future which is hiding in plain sight. This series highlights some of these old ideas.

*This is an introductory segment which is loosely focused on*

## Healthcare and Medical

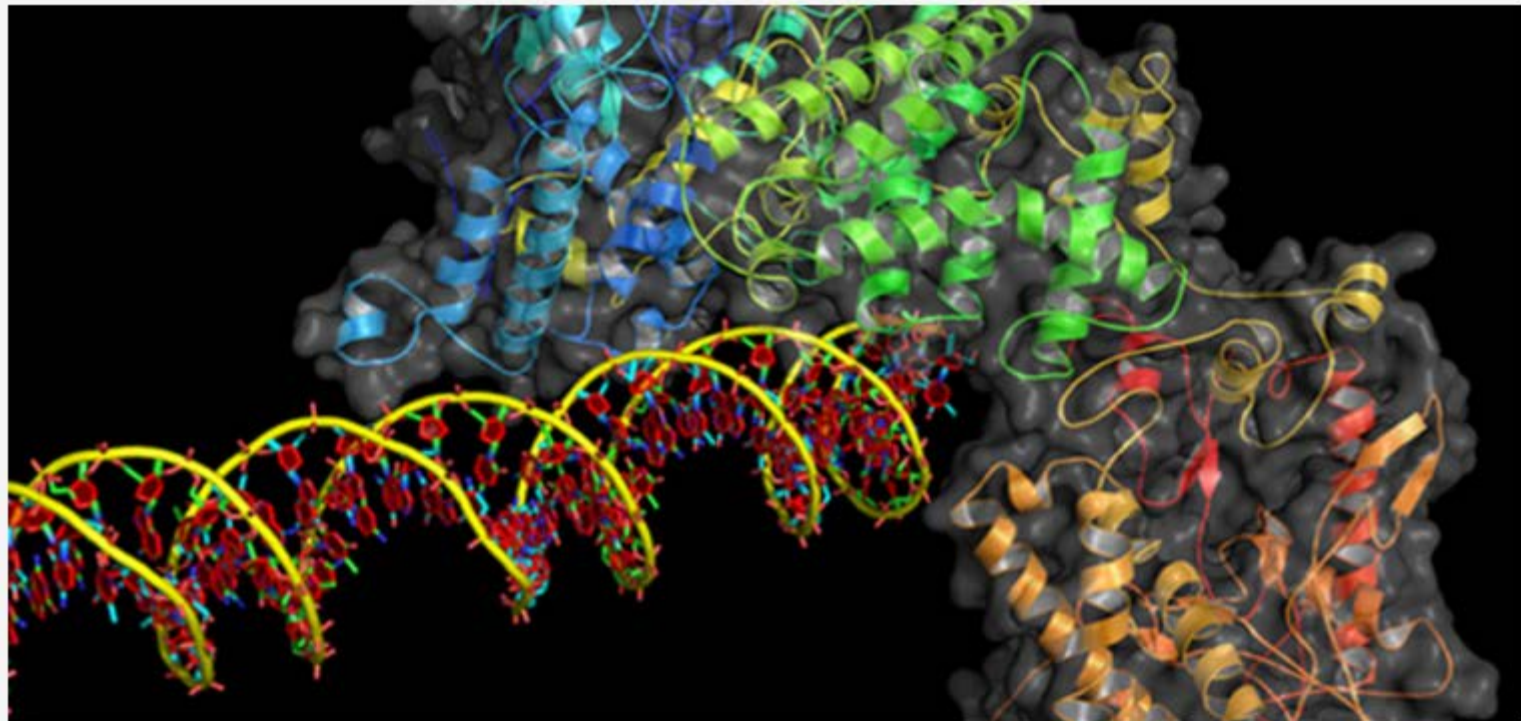

Image: Joung lab

<http://bit.ly/MIT-IOT>

*A solution – medical internet of things*



MIoT

<http://bit.ly/IOT-MIT>

1989 • (Department of Medicine) Massachusetts General Hospital, Harvard Medical School



SD



Dr J Larry Jameson MD PhD Molecular Endocrinology / Neuro-Endocrinology Dr Ann Klibanski MD



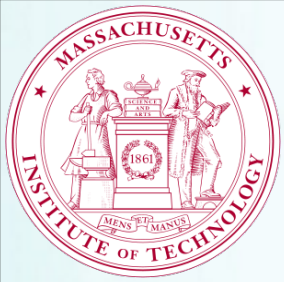

30,200 active  
companies



4.6 million people  
employed



\$1.9 trillion in  
annual revenues



<http://web.mit.edu/innovate/entrepreneurship2015.pdf>

A new report estimates that, as of 2014, MIT alumni have launched 30,200 active companies, employing roughly 4.6 million people, and generating roughly \$1.9 trillion in annual revenues.

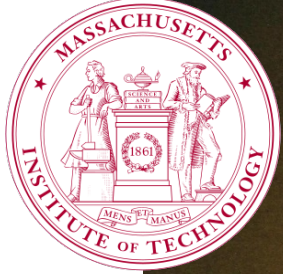

Room 1-179 MIT

1989 ● Massachusetts General Hospital, Harvard Medical School

1999 ● MIT Auto ID Center ● RFID EPC Technology Board

2001 ● MIT Forum for Supply Chain Innovation

2003 ● MIT Data Center ● **Semantics**

2009 ● MIT Energy Initiative

# Integrating Ubiquitous Analytics in Real-Time with Data, Information, Application

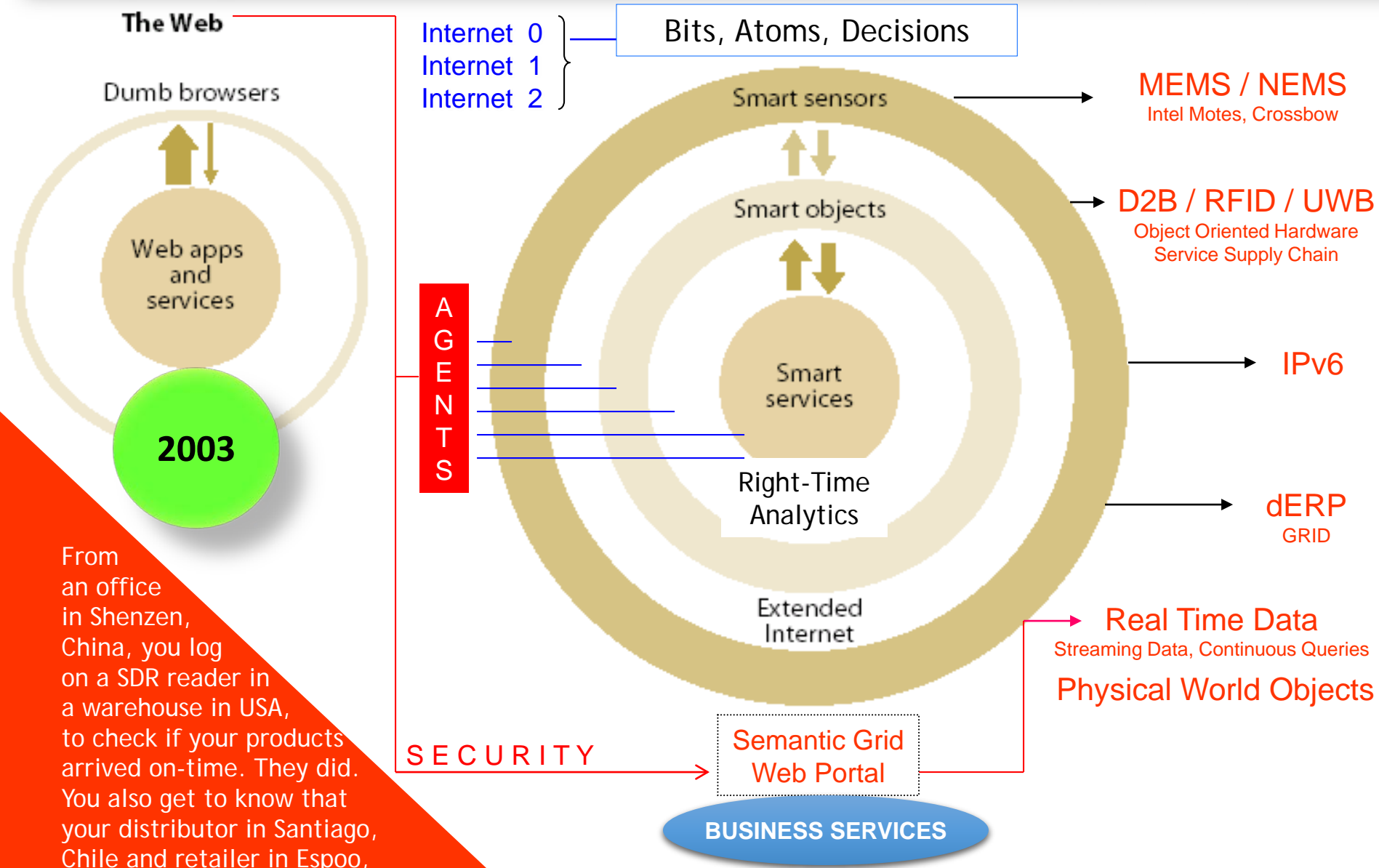

From an office in Shenzhen, China, you log on a SDR reader in a warehouse in USA, to check if your products arrived on-time. They did. You also get to know that your distributor in Santiago, Chile and retailer in Espoo, Finland also checked the delivery status, moments before you logged on.

## ADAPTIVE VALUE NETWORKS

*Convergence of Emerging Tools, Technologies and Standards as Catalytic Drivers\**

Shoumen Datta<sup>1</sup>, Bob Betts<sup>2</sup>, Mark Dinning<sup>3</sup>, Feryal Erhun<sup>4</sup>, Tom Gibbs<sup>5</sup>, Pinar Keskinocak<sup>6</sup>, Hui Li<sup>1</sup>, Mike Li<sup>1</sup>, Micah Samuels<sup>7</sup>

*Massachusetts Institute of Technology<sup>1</sup>, Timogen Inc.<sup>2</sup>, Dell Corporation<sup>3</sup>, Stanford University<sup>4</sup>, Intel Corporation<sup>5</sup>, Georgia Institute of Technology<sup>6</sup>, Amazon.com<sup>7</sup>*

**Abstract:** If a typhoon in the South China Sea impacts the shipment and delivery of memory chips to an assembly plant in Mexico City, you can count on the ripple effect to impact financial service providers, manufacturers and suppliers, shippers in charge of logistics and of course, the end-consumer. Can we plan to reduce the risk arising from such uncertainties? Can businesses (semiconductor plants, banks, logistics providers) cooperate to minimize uncertainties? Conventional wisdom states that uncertainties are equivalent to accidents and hence by nature remain unpredictable. However, application of tools and technologies based on emerging standards may partially disprove such wisdom. Focus on demand management may be the guiding light for supply chain practitioners. Can we collapse information asymmetries (between manufacturers and their lending institutions, for example) and add far more value to networks or demand webs? Real-time operational adaptability is key, especially in fast 'clockspeed' industries. Confluence of emerging tools, technologies and standards are required to converge to catalyze the evolution of such adaptable enterprise. Can real-time distributed data, in-network processing, Agent-based autonomy, taken together, tame the Bullwhip Effect? Can the (semantic) web catalyze the "Nash Equilibrium" of people (games) and information (theory) in our quest for real time "predictive" decision support systems? We will explore a few of these issues and how they may coalesce to enable the adaptive value network of the future.

2004

## EVOLUTION OF SUPPLY CHAIN MANAGEMENT

### Symbiosis of Adaptive Value Networks and ICT



Edited by  
Yoon S. Chang  
Harris C. Makatsoris  
Howard D. Richards



Dr Joseph James Salvo  
Founder & Director IIC, GE

Dr Shoumen Datta, Senior Vice President

# Industrial Internet vs Consumer Internet



Jeff Immelt, GE Minds & Machines conference, San Francisco, Nov. 2012



Tim Cook, Apple Special Event, San Francisco, Sept 2014

**One decade ago, my research group** at the University of Tokyo created a flexible electronic mesh and wrapped it around the mechanical bones of a robotic hand. We had dreamed of making an electronic skin, embedded with temperature and pressure sensors, that could be worn by a robot. If a robotic health aide shook hands with a human patient, we thought, this sensor-clad e-skin would be able to measure some of the person's vital signs at the same time.

Today we're still working intensively on e-skin, but our focus is now on applying it directly to the human body. Such a bionic skin could be used to monitor medical conditions or to provide more sensitive and lifelike prosthetics.



Photo: Someya-Sekitani Group

**Gilded skin:** Takao Someya's latest e-skin material is one-tenth the thickness of plastic kitchen wrap, and it can conform to any body shape.

# Entirely Different Outcome

Medical IoT

Internet of Systems for Healthcare









*prevents cancer*

# FitBit's Claim in Cancer Prevention

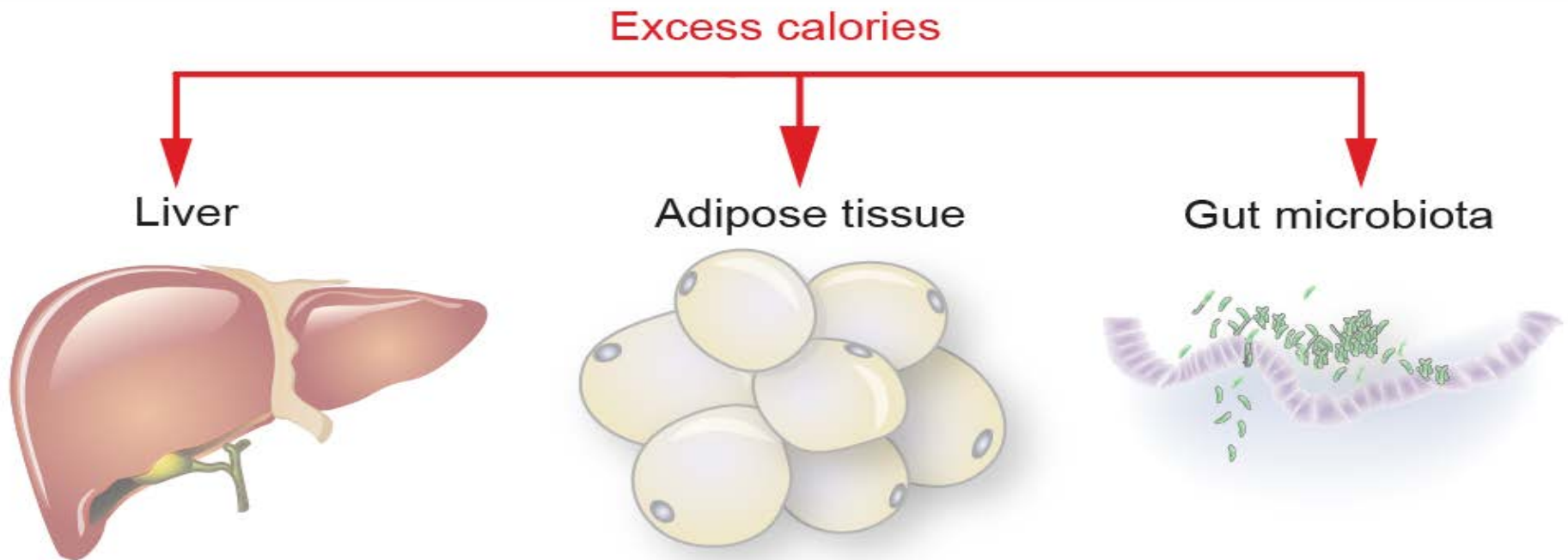

## Cirrhosis-independent effects of exercise in Hepatocarcinogenesis

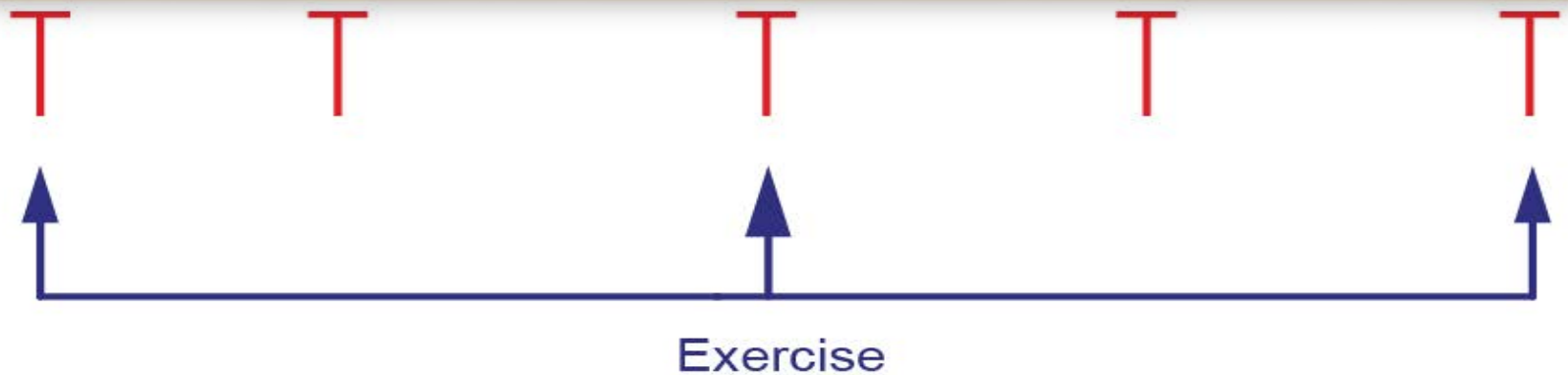

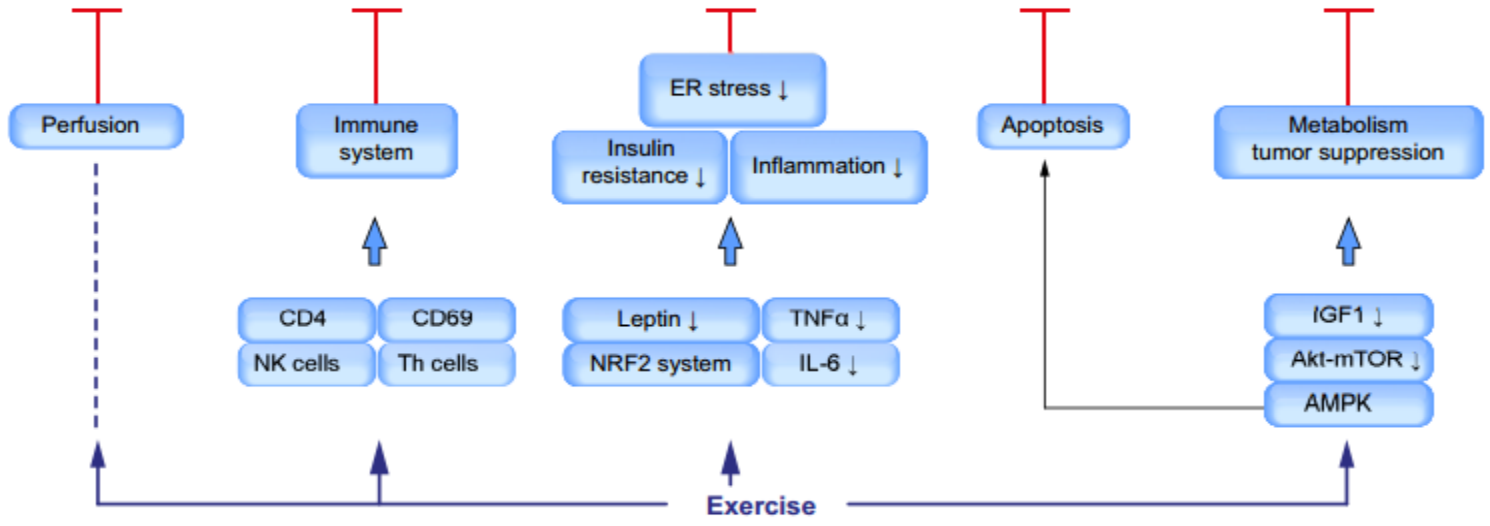
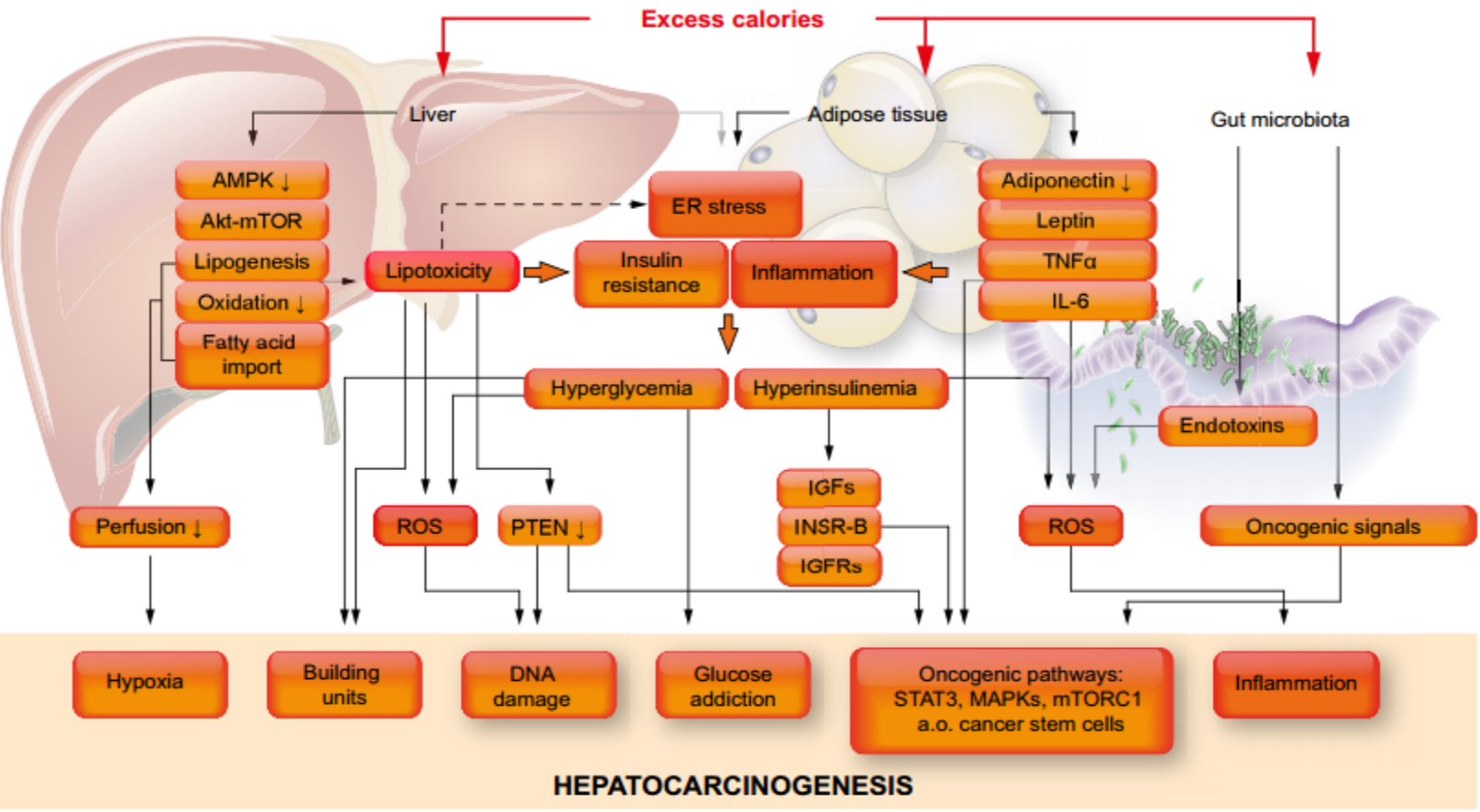

# Electronic Nose Sniffs Out Ovarian Cancer in Exhaled Breath

OCTOBER 6TH, 2015

EDITORS

NANOMEDICINE, ONCOLOGY



We know that exhaled breath contains biomarkers that point to presence of existing disease, including cancer, but their detection is challenging without bulky and expensive equipment. Building specialized devices that detect volatile organic compounds linked to disease requires large sensor arrays, a limitation that has made them currently impractical. Now researchers at Technion -Israel Institute of Technology and Carmel Medical Center in Haifa, Israel have developed tiny flexible sensors that are each able to replicate the work of many. In a study testing the breath of 43 volunteers that included 17 ovarian cancer patients, their sensors achieved an 82% accuracy of detection.

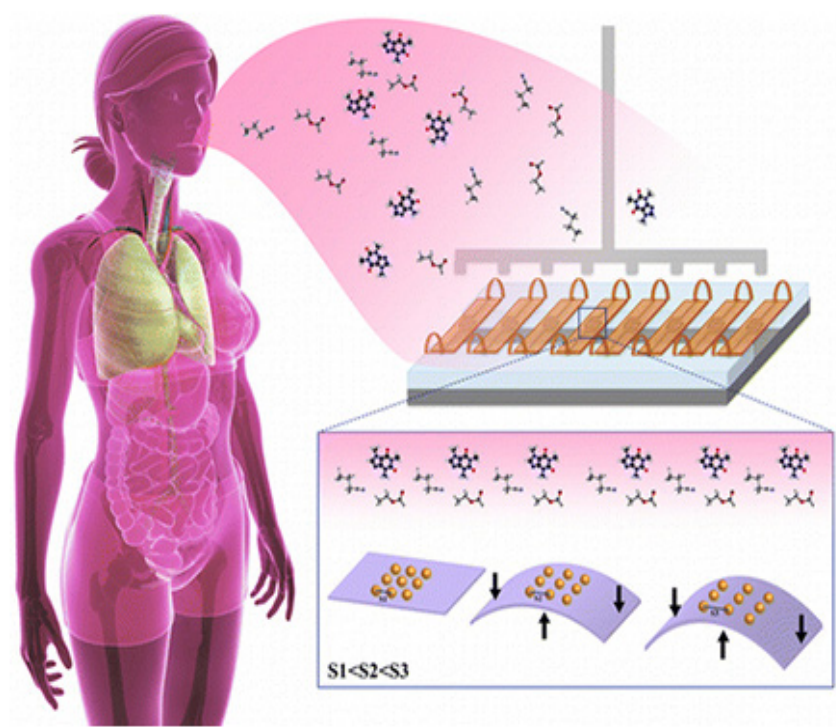

The sensors are flexible and are made of gold nanoparticles that have molecules onto which volatile organic compounds (VOCs) attach to. When captured, the different VOCs bend the sensors at different angles depending on their nature and provide more information than simply whether they're there or not.

**Dynamic Nanoparticle-Based Flexible Sensors: Diagnosis of Ovarian Carcinoma from Exhaled Breath**

Nicole Kahnt<sup>†</sup>, Ofer Lavie<sup>‡</sup>, Moran Paz<sup>‡</sup>, Yaki Segev<sup>‡</sup>, and Hossam Haick<sup>†\*</sup>  
<sup>†</sup> Department of Chemical Engineering and Russell Berrie Nanotechnology Institute, Technion-Israel Institute of Technology, Haifa 320003, Israel  
<sup>‡</sup> Gynecological Oncology and Surgery Unit, Carmel Medical Center, Haifa 3436212, Israel  
\*E-mail: [hossam@technion.ac.il](mailto:hossam@technion.ac.il)  
Nano Lett., Article ASAP  
DOI: 10.1021/acs.nanolett.5b03052  
Publication Date (Web): September 9, 2015  
Copyright © 2015 American Chemical Society

# Malaria Diagnosis Using a Mobile Phone Polarized Microscope

Casey W. Pirnstill  & Gerard L. Côté

*Scientific Reports* 5, Article number: 13368

(2015)

doi:10.1038/srep13368

Received: 19 March 2015

Accepted: 14 July 2015

Published online: 25 August 2015

*Poverty magnifies the need for health care while shrinking the capacity to finance it. Low-income countries face 56 percent of the global disease burden but account for only 2 percent of global health spending (World Bank 2005; Mathers, Lopez, and Murray, forthcoming). With spending levels of some \$30 per capita on average, over half of it out of pocket, low-income countries face severe challenges in providing their*

# The Leapfrog Opportunity In The World's Underserved Health Care Markets



President Uhuru Kenyatta of Kenya

[+ Comment Now](#)

In Sub-Saharan Africa, traditional banking infrastructure has never quite gained a foothold. That's because instead of brick and mortar vaults, the region has seen sweeping use of mobile banking. Microfinancing and transfers, all from your cell phone, offered simplified, safer banking solutions for a fraction of the cost.

This is an example of "leapfrog" innovation and the same paradigm is beginning to emerge in [health](#) care in Africa, [Asia](#) and Latin America, creating a global opportunity for health innovators.

This past week President Obama was in Africa at the Global Entrepreneurship Summit [calling on entrepreneurs and industry leaders to ignite growth on that continent](#) and beyond. The question is will the leaders in today's largest health care [markets](#) seize the moment? Or will upstarts leap over them by bringing radically less expensive and more accessible healthcare options to the rest of the world?

# 69 Healthcare Start-ups

## BRAIN



## LUNGS



## LIVER



## GASTROINTESTINAL



## AUTOIMMUNE



## BLOOD



## HEART



## KIDNEY

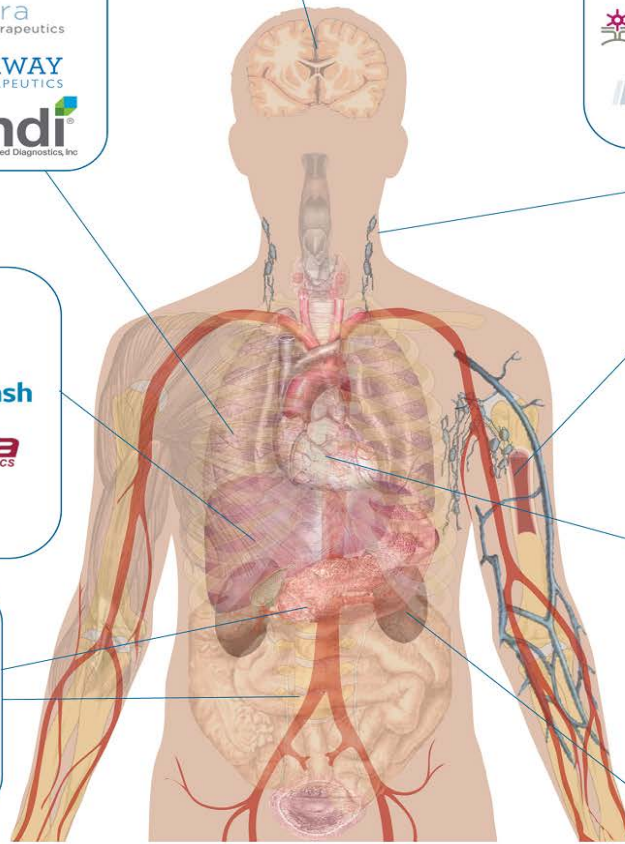



# 80/20

US consumes 40% (approx) of the world's total financial resources for healthcare. The remaining OECD nations consume 40%.

<b>Total global expenditure for health<sup>1</sup></b>	<b>US\$ 6.5 trillion</b>
Total global expenditure for health per person per year	US\$ 948
Country with highest total spending per person per year on health	United States (US\$ 8362)
Country with lowest total spending per person per year on health	Eritrea (US\$ 12)
Country with highest government spending per person per year on health	Luxembourg (US\$ 6906)
Country with lowest government spending per person per year on health	Myanmar (US\$ 2)
Country with highest annual out-of-pocket household spending on health	Switzerland (US\$ 2412)
Country with lowest annual out-of-pocket household spending on health	Kiribati (US\$ 0.2)
Average amount spent per person per year on health in countries belonging to the Organisation for Economic Co-operation and Development (OECD)	US\$ 4380
Percentage of the world's population living in OECD countries	18% ← 20
Percentage of the world's total financial resources devoted to health currently spent	84% ← 80

# US Abhors Low Cost Healthcare Alternatives

## How the healthcare system discourages creating low-cost solutions

<http://jama.jamanetwork.com/article.aspx?articleid=2429454>

The U.S. leads the world in creating new drugs and healthcare tech, but the system discourages inventors from creating cost-lowering technologies in favor of ones with a healthy return on investment, according to an [article](#) at the *Journal of the American Medical Association*.

"In the United States, the surest way to generate a healthy return on investment is to increase health care spending, not reduce it," says the authors, from the Uniformed Services University of the Health Sciences and Yale School of Medicine.

They use as an example a low-cost, once-a-day pill to treat cardiovascular disease, with the estimated potential to reduce the incidence of myocardial infarction and stroke by more than 80 percent.



This \$153,000 rattlesnake bite is everything wrong with

# American Healthcare

<http://bit.ly/US-MEDICAL-WASTE>

Statement Date		July 13, 2015
Your payment is due:	July 27, 2015	
Your balance due is:	\$153,161.25	Please send contact Med contact our status of y
<b>SUMMARY OF PATIENT SERVICES</b>		
PHARMACY	\$83,341.25	
LABORATORY SERVICES	\$22,433.00	
INTERMEDIATE CARE ROOM	\$21,225.00	
INTENSIVE CARE ROOM	\$17,766.00	
EMERGENCY CARE SERVICES	\$5,564.00	
THERAPY SERVICES	\$1,423.00	
RADIOLOGY	\$947.00	
SPECIAL SERVICES	\$462.00	
<b>TOTAL CHARGES</b>	<b>\$153,161.25</b>	
<b>ACCOUNT SUMMARY</b>		
Service Date	07/04/15 to 07/09/15	
Type of Service	EMERGENCY-IP	
Account #	11-82728390	
Billed/Total Charges	\$153,161.25	
Adjustments	\$0.00	
Insurance Payments	\$0.00	
Patient Payments	\$0.00	
Due From Insurance	\$0.00	
<b>This is your balance</b>	<b>\$153,161.25</b>	
PLEASE RETAIN THIS PORT		

\$153,161.25

US Hospital charges for Treatment Of Snake Bite



Dan Haggerty @10NewsHaggerty

US AV PER CAPITA INCOME <\$55,000

\$8,694

Median monthly  
cost in the US of  
eight cancer drugs

\$2,587

Median monthly  
cost in the UK of the  
same eight drugs

\$2,741

Median monthly  
cost in Australia  
of the same drugs



# Transaction Cost

*example of yet another dimension from Yale Law School*

Personal Health Care Spending in the United States by Age Group, Aggregated Condition Category, and Type of Health Care, 2013

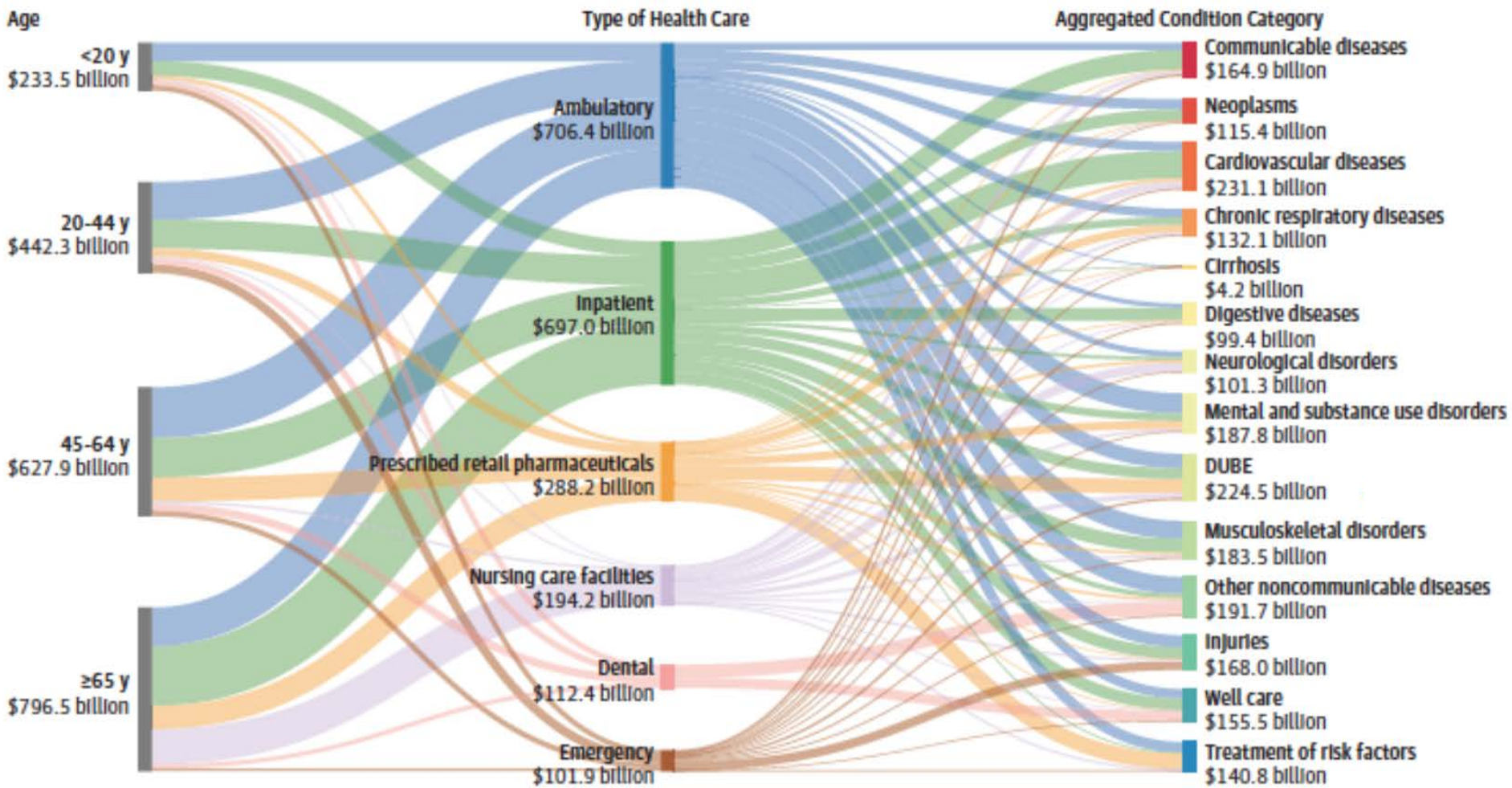

\$250 Billion US dollars  
\$0

<http://jamanetwork.com/journals/jama/fullarticle/2594716>  
<https://image-store.slidesharecdn.com/8250a975-308d-40a7-a573-e4c1ab8d791b-original.png>

DUBE indicates diabetes, urogenital, blood, and endocrine diseases. Reported in 2015 US dollars. Each of the 3 columns sums to the \$2.1 trillion of 2013 spending disaggregated in this study. The length of each bar reflects the relative share of the \$2.1 trillion attributed to that age group, condition

category, or type of care. Communicable diseases included nutrition and maternal disorders. Table 3 lists the aggregated condition category in which each condition was classified.

Joseph L. Dieleman, PhD<sup>1</sup>; Ranju Baral, PhD<sup>2</sup>; Maxwell Birger,

# TOTAL US HEALTHCARE SPENDING 1970-2015

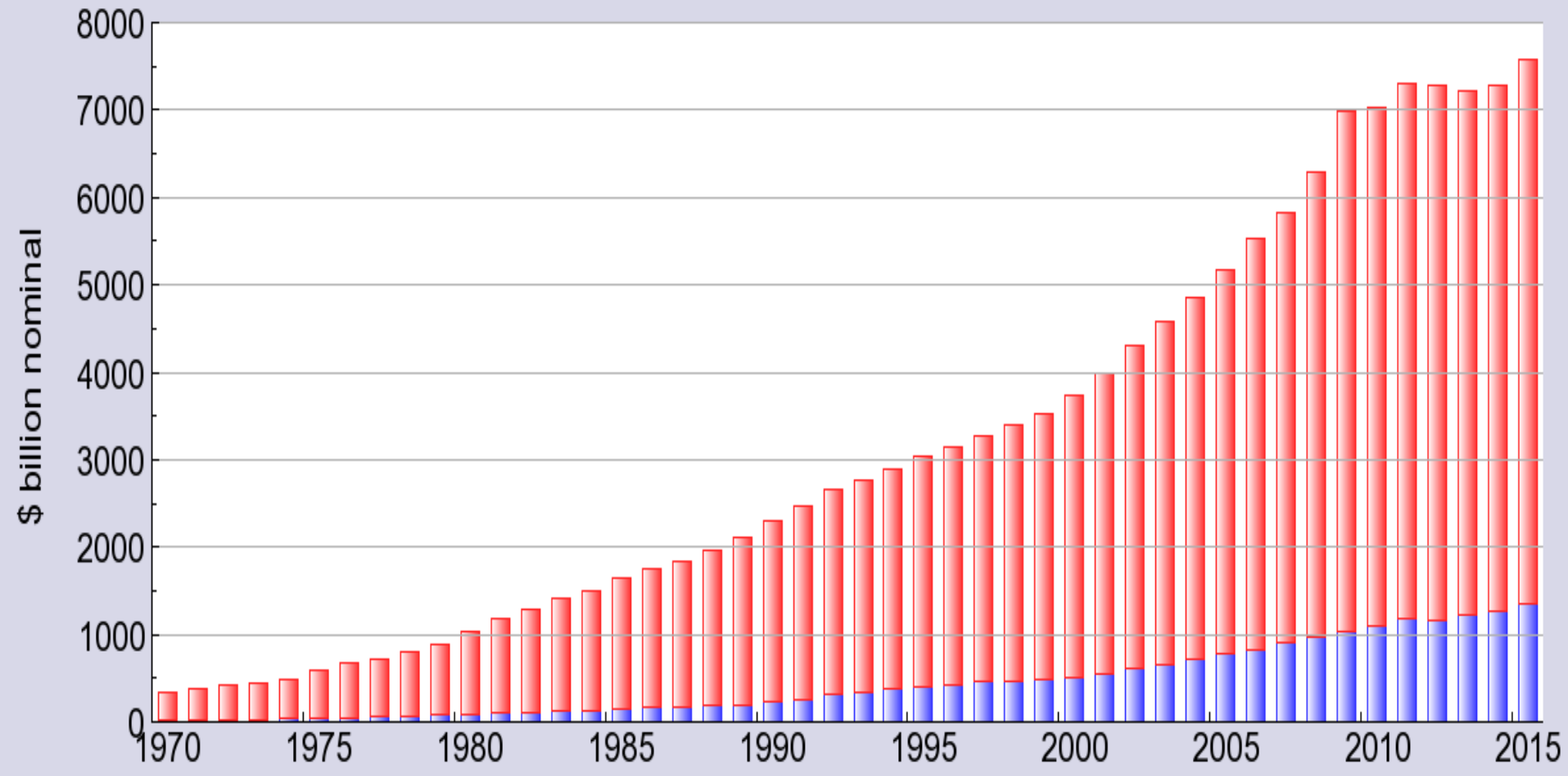

US healthcare spending  
explained by one word?



# Growth of Physicians and Administrators 1970-2009

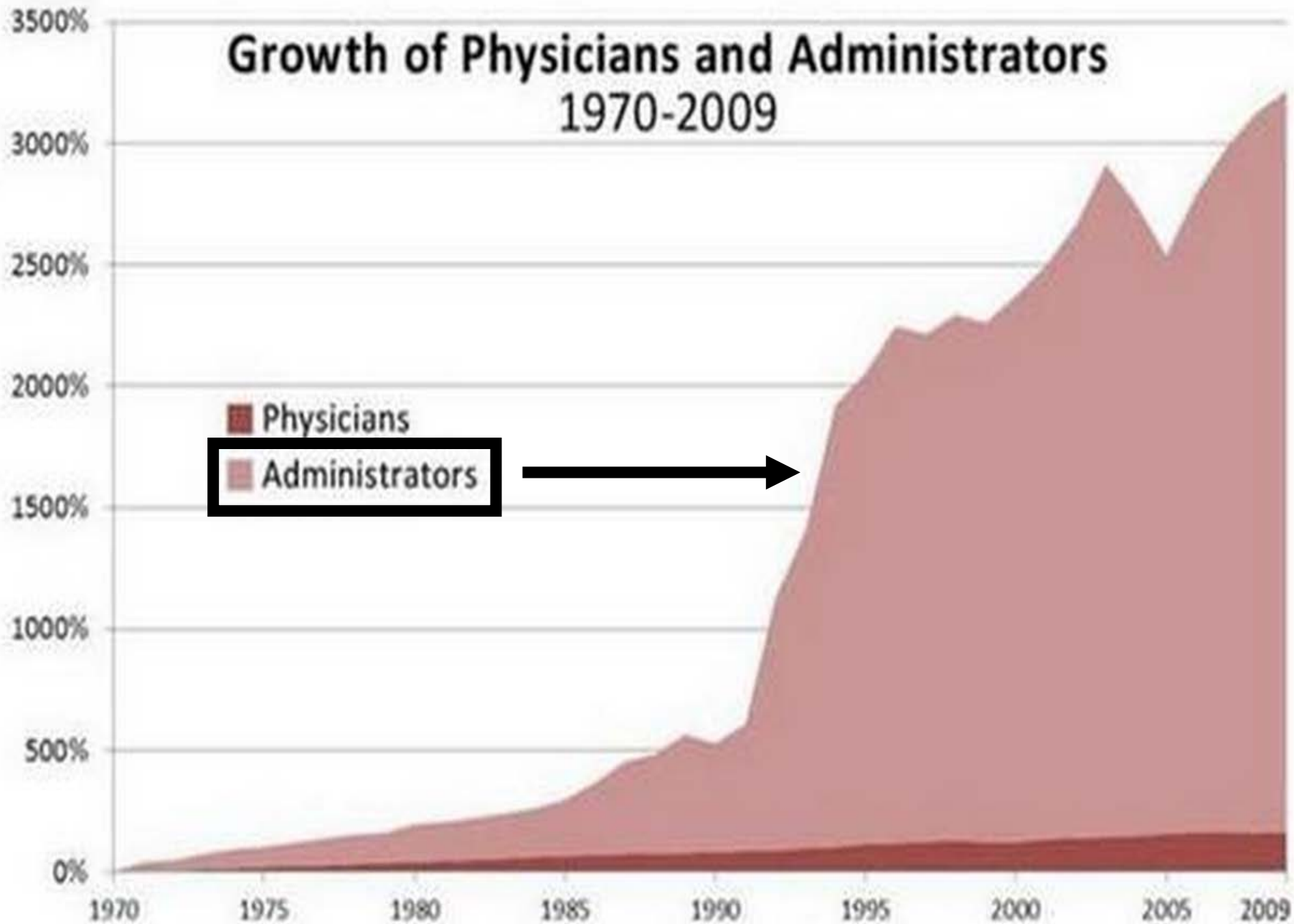

Source: Bureau of Labor Statistics; NCHS; and Himmelstein/Woolhandler analysis of CPS

English - detected ▾



the greatest good

Japanese ▾



最大の良いです

Saidai no yoidesu

[Open in Google Translate](#)

English - detected ▾



the greatest greed

Japanese ▾



最大の欲

Saidai no yoku

[Open in Google Translate](#)

BUSINESS 6/18/2012 @ 7:59AM | 98,482 views

# The Staggering Cost Of An Epic Electronic Health Record Might Not Be Worth It

[Judy Faulkner](#) once walked into a roomful of hospital CIOs, tossed her macramé handbag on a table, and announced she came to decide who she wanted as customers. Faulkner doesn't do marketing. The formidable founder of electronic health records Epic Systems boasts an enviable roster of customers made up of prestigious hospitals and academic centers. She has quietly convinced them that her product is best: a single, seamless database—the fruit of a company that has grown organically, and shunned acquisitions. And, because it is no small task to deploy, she is there all the way to hand-hold jittery CIOs, and help them get millions of dollars in government subsidies by showing meaningful use of her EHR.

Her not-for-profit clientèle will need every penny of those taxpayers' dollars, but they won't cover anywhere near the staggering cost of an Epic EHR. [Duke University Health System](#) will shell out \$700 million, so will [Boston](#)-based Partners HealthCare; University of California, [San Francisco](#) will pay \$150 million.

\$700  
million

# Healthcare

Let us look elsewhere

# Maternal Mortality Is Rising in the U.S. As It Declines Elsewhere

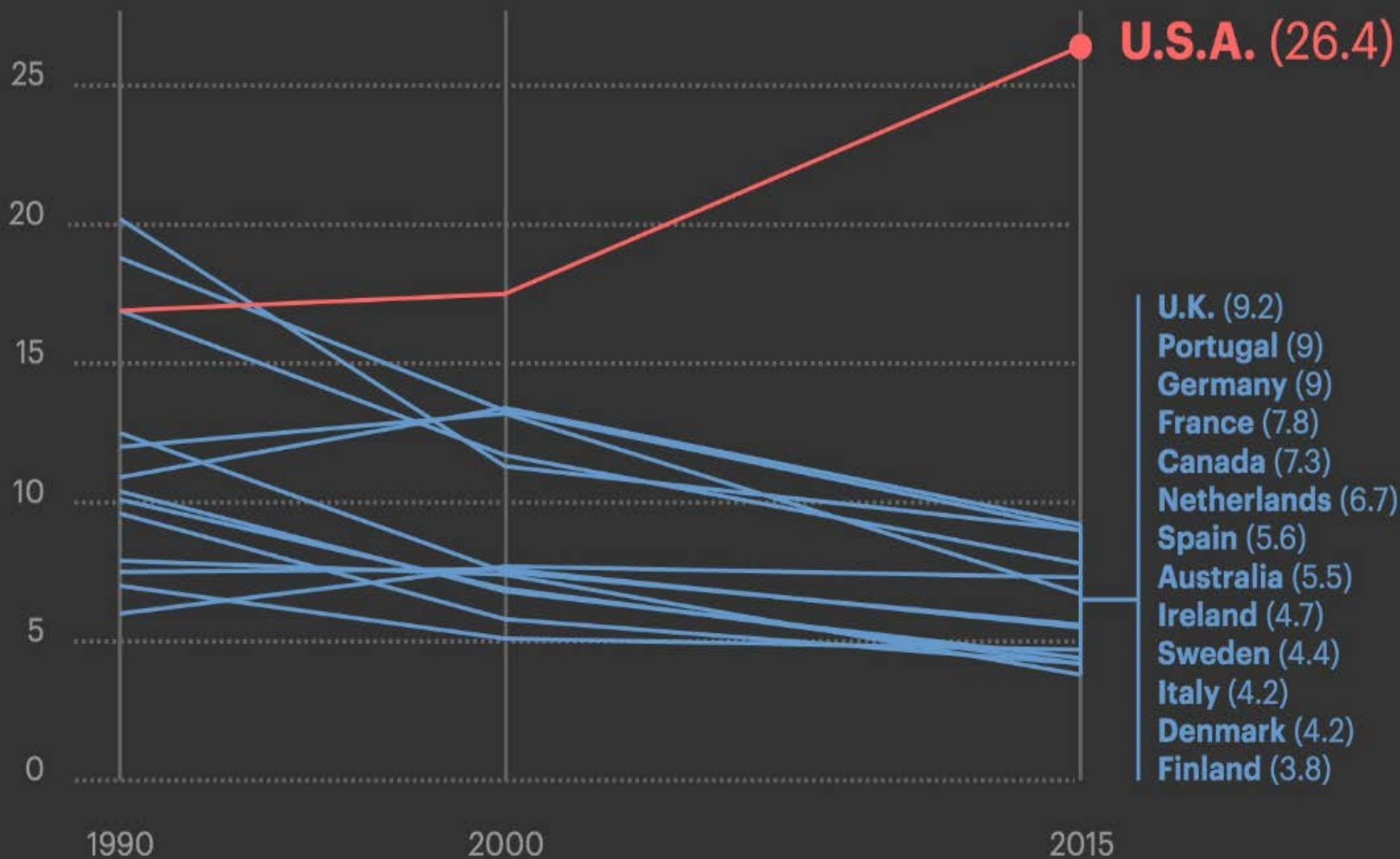

Per 100,000 live births. Source: "Global, regional, and national levels of maternal mortality, 1990–2015: a systematic analysis for the Global Burden of Disease Study 2015," *The Lancet*. Note: Only data for 1990, 2000 and 2015 was made available in the journal.

# Leading causes of death in the USA

1. 597,689 Heart Disease
2. 574,743 Cancer
3. 138,080 Chronic lower respiratory diseases
4. 129,476 Stroke
5. 120,859 Accidents
6. 83,494 Alzheimer's disease
7. 69,071 Diabetes
8. 56,979 Influenza & Pneumonia
9. 47,112 Kidney diseases
10. 41,149 Suicide

**Patient Safety 2013**  
Exploring Quality of Care in the U.S.

## How Many Die From Medical Mistakes in U.S. Hospitals?



A New, Evidence-based Estimate of Patient Harms Associated with Hospital Care

*John T. James, PhD*

Dr Julian Goldman



1999  
IOM report

**98,000**  
deaths due to error

**210,000 – 440,000 deaths**

400,000 deaths due to medical mistakes – shared with the US Senate

# Deaths by medical mistakes hit records



*Tejal Gandhi, MD, president of the National Patient Safety Foundation and associate professor of medicine, Harvard Medical School, spoke at the hearing.*

## The way IT is designed remains part of the problem

WASHINGTON | July 18, 2014

It's a chilling reality – one often overlooked in annual mortality statistics: Preventable medical errors persist as the No. 3 killer in the U.S. – third only to heart disease and cancer – claiming the lives of some **400,000 people** each year. At a Senate hearing Thursday, patient safety officials put their best ideas forward on how to solve the crisis, with IT often at the center of discussions.

Hearing members, who spoke before the Subcommittee on Primary Health and Aging, not only underscored the devastating loss of human life – more than 1,000 people each day – but also called attention to the

fact that these medical errors cost the nation a colossal **\$1 trillion each year**.

"The tragedy that we're talking about here (is) deaths taking place that should not be taking place," said subcommittee Chair Sen. Bernie Sanders, I-Vt., in his opening remarks.



# Third Leading cause of death in the USA ?

1. 597,689 Heart Disease
2. 574,743 Cancer
- 3. *Deaths Due to Medical Errors (180,000 - 210,000 - 440,000)***
4. 138,080 Chronic lower respiratory diseases
5. 129,476 Stroke
6. 120,859 Accidents
7. 83,494 Alzheimer's disease
8. 69,071 Diabetes
9. 56,979 Influenza & Pneumonia
10. 47,112 Kidney diseases
11. 41,149 Suicide

**Total Health Care Expenditures  
Percent of GDP, 1960-2008**

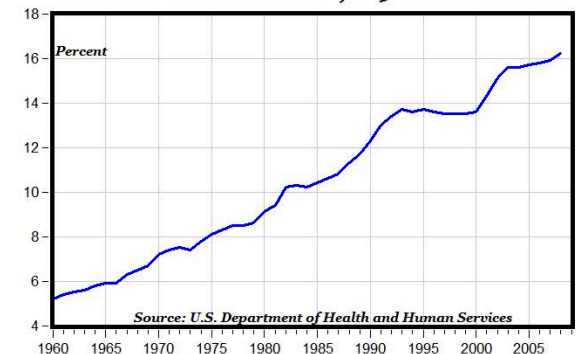

*Equivalent to at least one 747 airplane crash every day*

# Nurses blame interoperability woes for medical errors

**\$30B could be saved each year from better device coordination**

March 16, 2015

Each year, a staggering 400,000 people are **estimated to have died** due to medical errors. What's more, each day there's also 10,000 serious complications resulting from medical mistakes. Part of the blame, nurses are saying, can be attributed to the lack of **interoperability** among medical devices.



Change Expectations > Change Technology > Change Healthcare  
*The Medical Device "Plug-and-Play" (MD PnP) Interoperability Program is promoting innovation in patient safety and clinical care by leading the adoption of patient-centric integration of medical devices and IT systems in clinical environments.*

[HOME](#) | [ABOUT PROGRAM](#) | [PROJECTS](#) | [NEWS](#) | [EVENTS](#) | [PUBLICATIONS & TALKS](#) | [OUR LAB](#)

[Sitemap](#)

**Medical Device "Plug-and-Play" Interoperability Program  
working on "safe interoperability™" to improve patient safety**

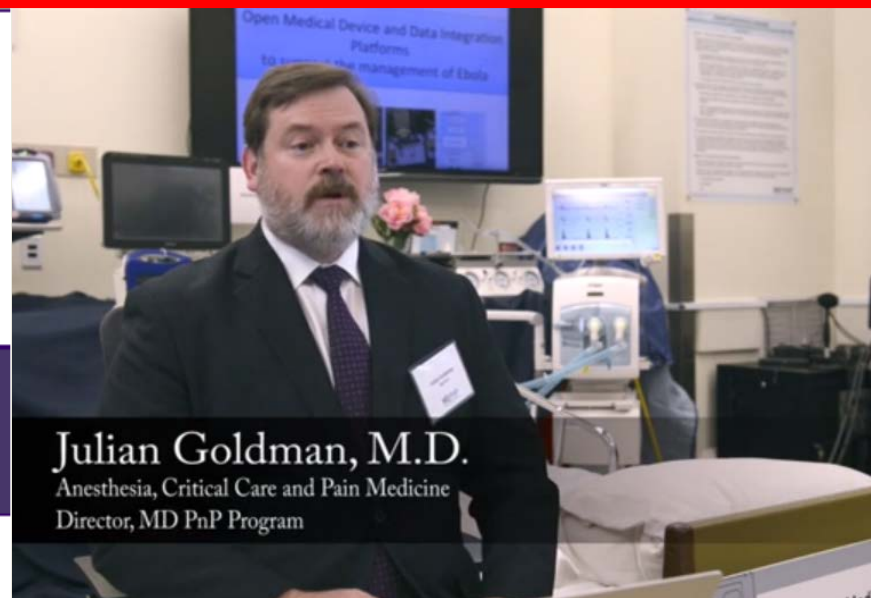

**Julian Goldman, M.D.**  
Anesthesia, Critical Care and Pain Medicine  
Director, MD PnP Program

**MD PnP MedTech Hackathon Open Medical Device and Data Integration Platforms to Support the Management of Ebola**

# Most Medical Devices Today stand alone, unintegrated, not patient-centric

- Philips Intellivue Series Monitors
- GE Solar 8000x / Dash 4/5000
- Dräger Apollo / EvitaXL / V500
- Nonin Bluetooth OnyxII 9650 / WristOx 3150
- Oridion Capnostream20
- Ivy 450C
- Nellcor N-595
- Masimo Radical-7



# Screen capture from intra-operative EMR during surgery



# Device Manufacturers Builds Things, not Systems

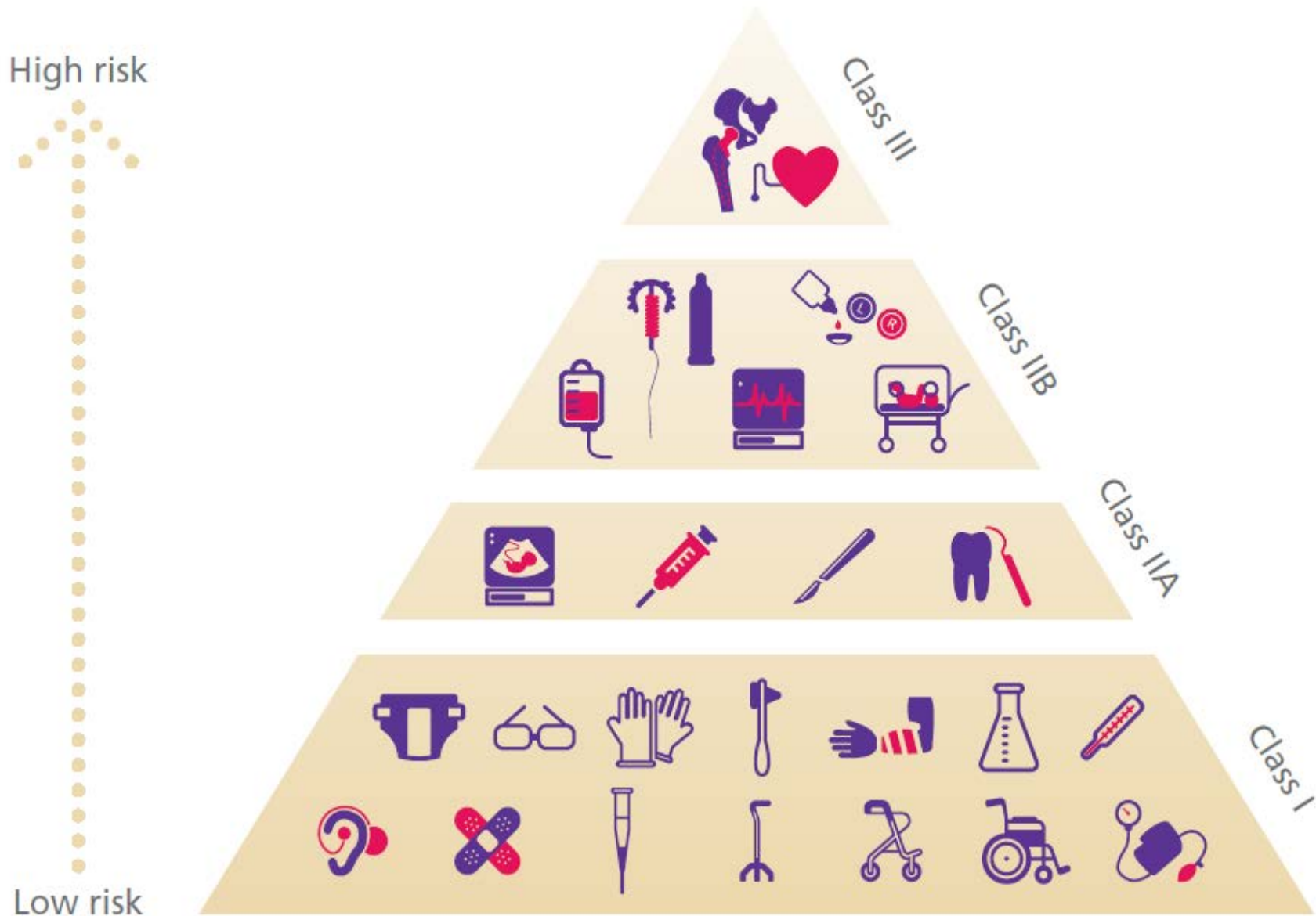

# ONE APPROACH

Devices that can talk to each other and synthesize data to present an integrated physiological status that is patient centric and updates patient medical records

# Autonomous Control of Morphine Infusion Pump – Medical Device Integration Model

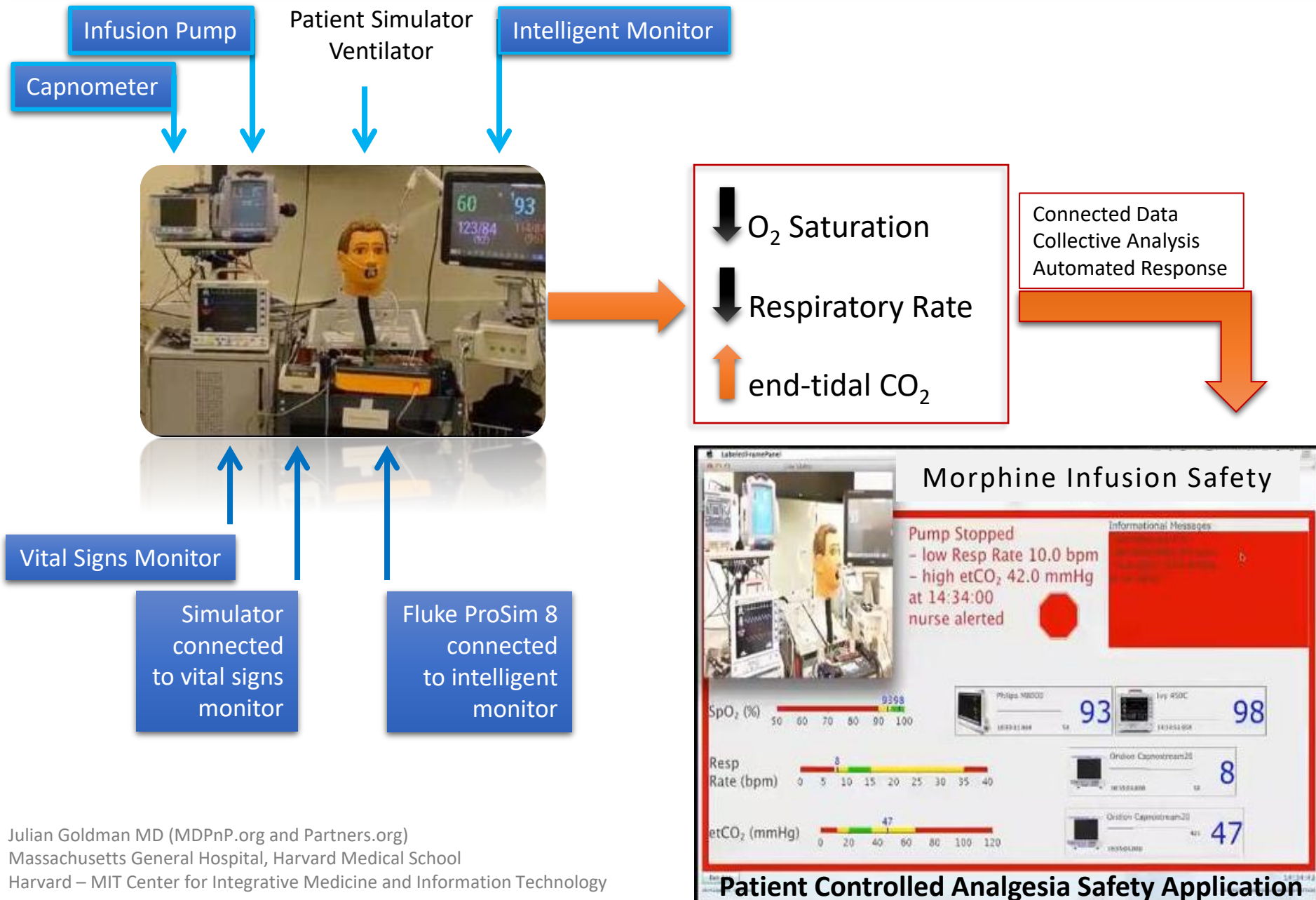

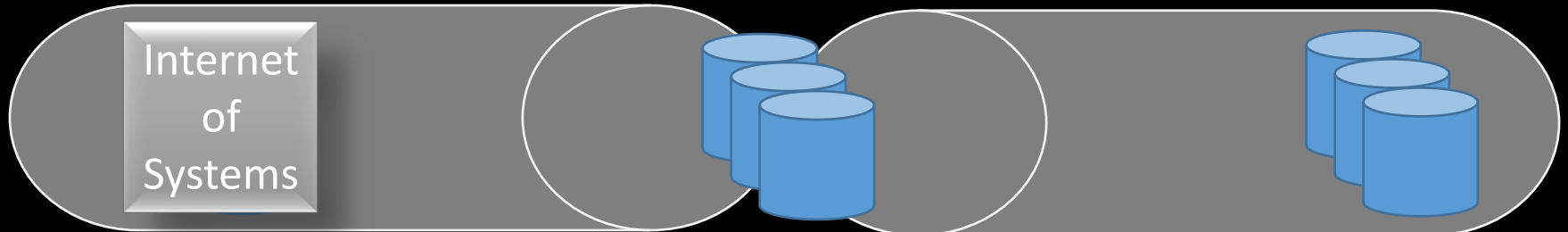
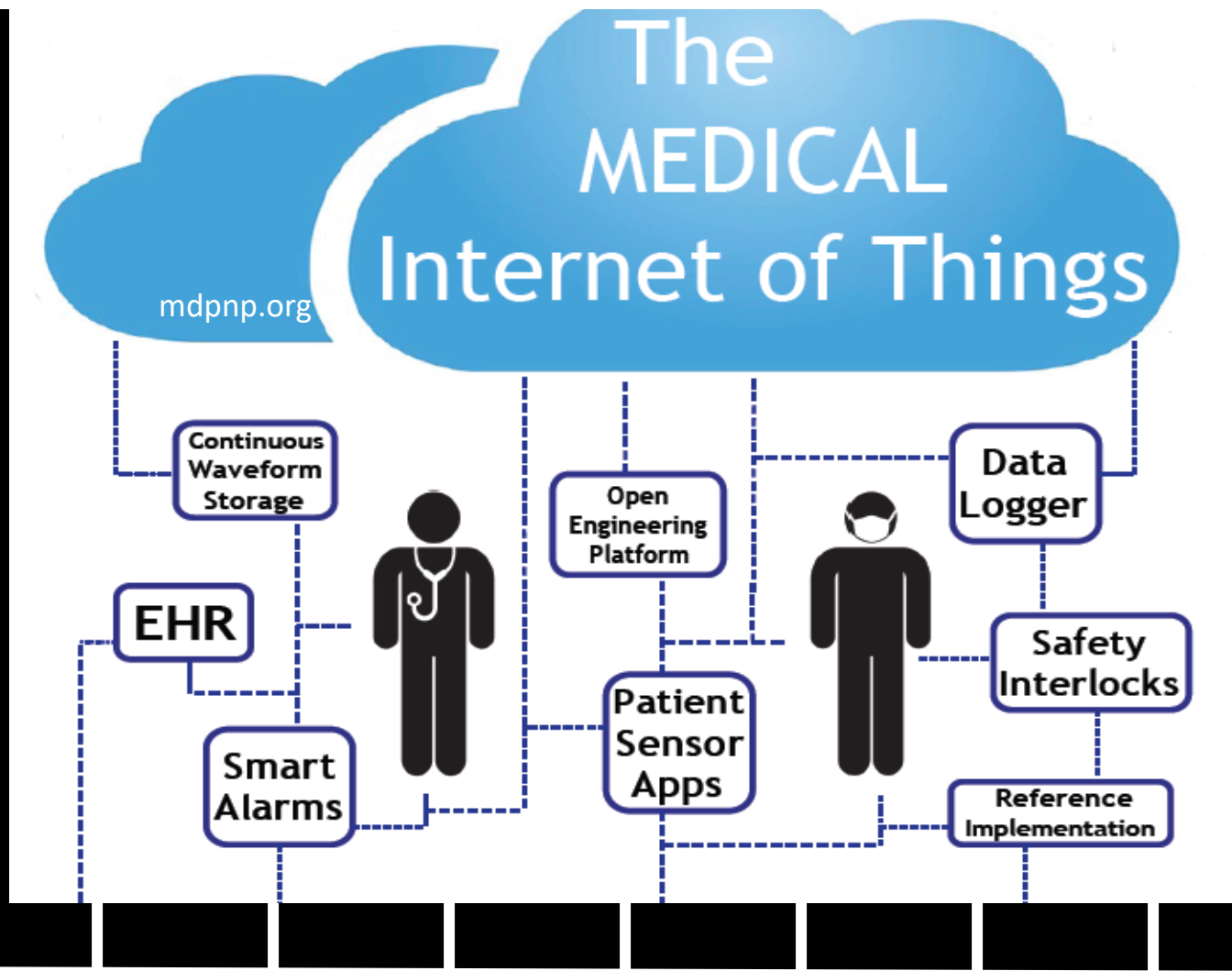



# Autonomous Control of Morphine Infusion Pump – Medical Device Data Integration

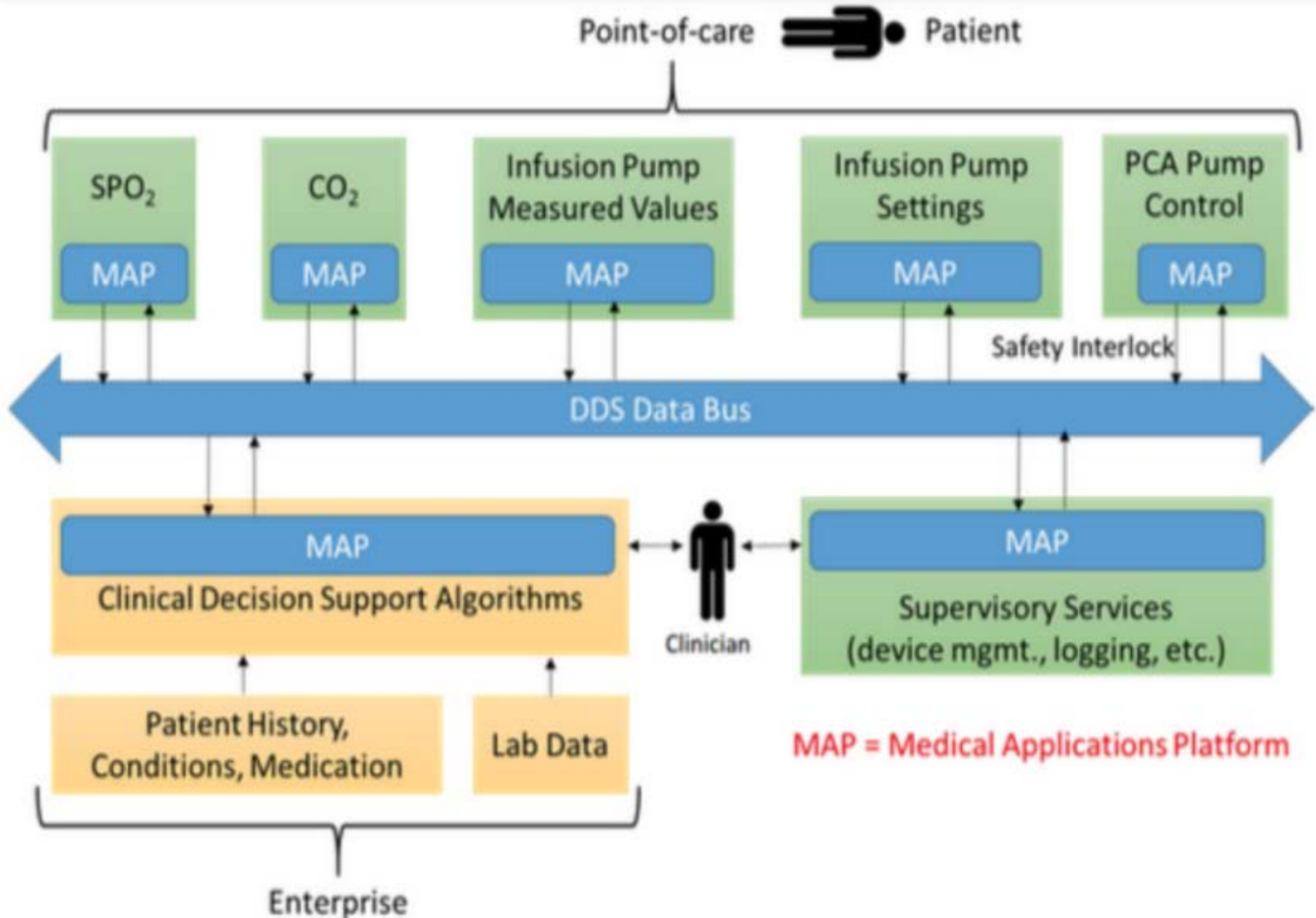





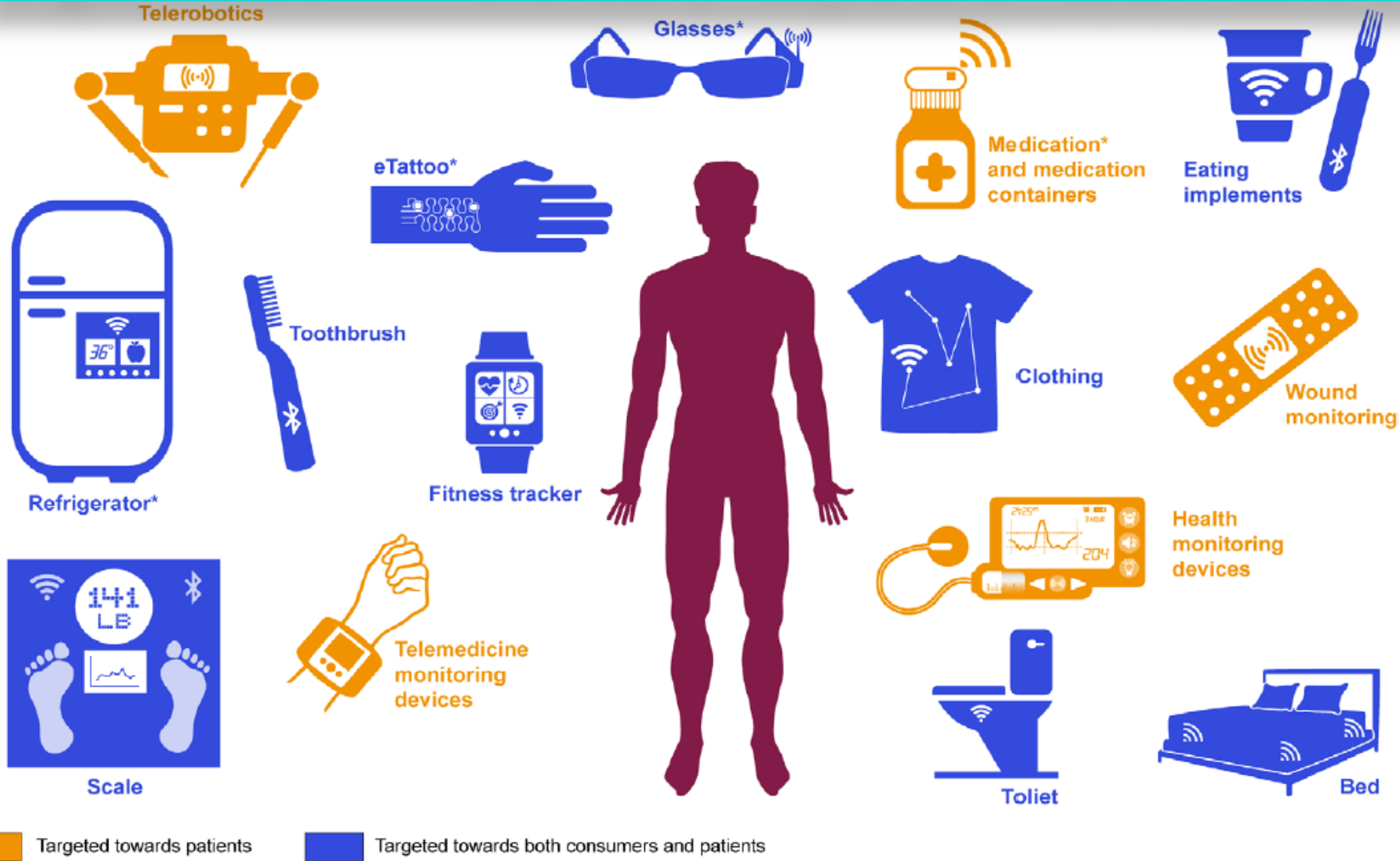

# Digital Health – Prevention, People and Patient-centric



Critical need in healthcare to reduce transaction cost

# Digital Transformation ↑ Patient-centric Healthcare

Healthcare Category		Key drivers of
<b>Innovation</b>		<ul style="list-style-type: none"> <li>Accelerating discovery in research</li> <li>Improving trial operations</li> </ul>
<b>Care</b>		<ul style="list-style-type: none"> <li>Alignment around proven pathways</li> <li>Coordinated care across providers</li> </ul>
<b>Provider</b>		<ul style="list-style-type: none"> <li>Shifting volume to right care setting</li> <li>Reducing emergency room/readmit</li> </ul>
<b>Value</b>		<ul style="list-style-type: none"> <li>Payment innovation and alignment</li> <li>Provider-performance transparency</li> </ul>
<b>Lifestyle</b>		<ul style="list-style-type: none"> <li>Targeted disease prevention</li> <li>Data-enabled adherence programs</li> </ul>

GAO-16-659SP

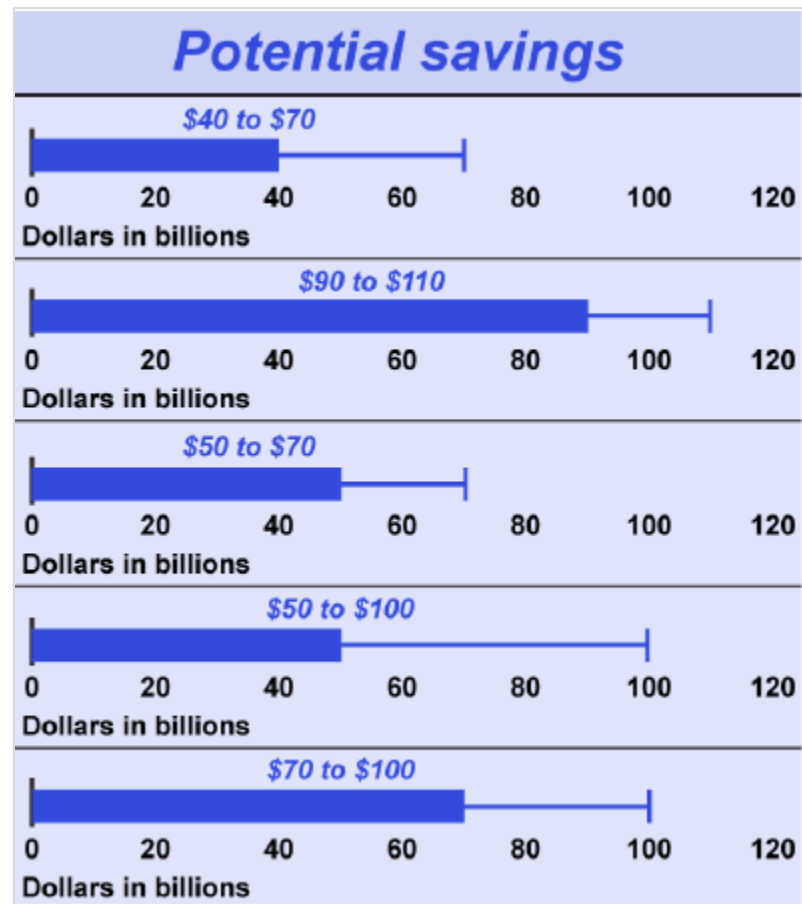

Potential for savings from reducing transaction costs?

# KEY REQUIREMENT

Devices that can serve the masses and an open yet secure platform for interoperability and data fusion

# Healthcare Platforms – Integrated Clinical Environment Data Logging & Access via Secure Interoperable Standard

Imaging



EHR-Admin



EMR-Physician



Clinical Devices



Medical History



Internet  
of  
Systems

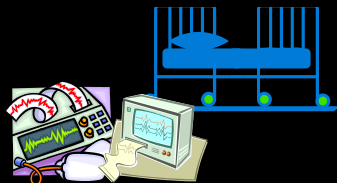
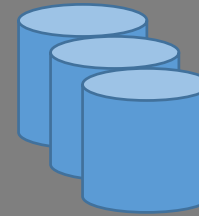
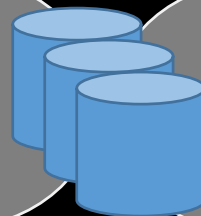

Clinic - Ward



Pharmacy



Laboratory



Exchanges



Devices



Homecare

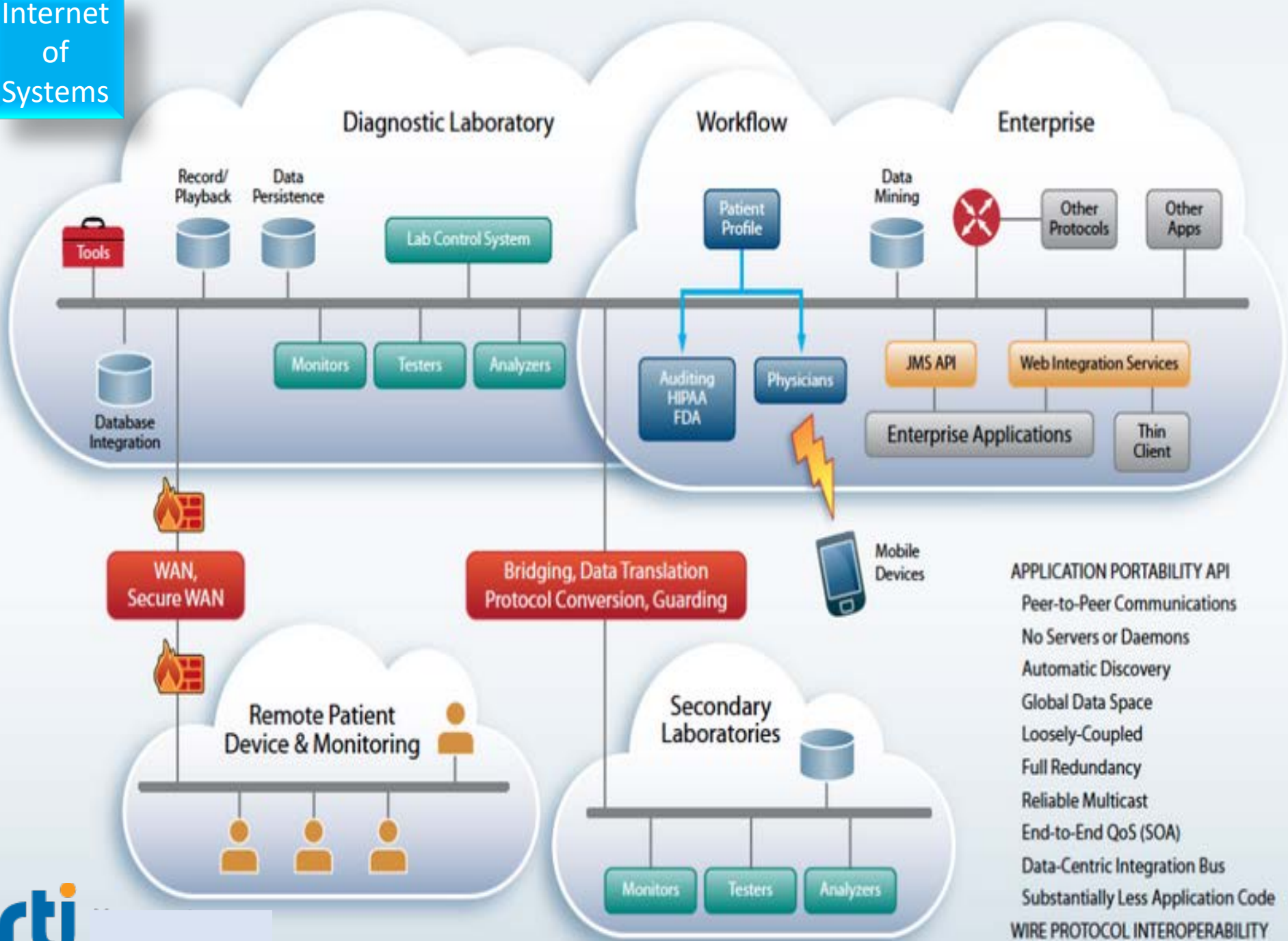

- APPLICATION PORTABILITY API**
- Peer-to-Peer Communications
  - No Servers or Daemons
  - Automatic Discovery
  - Global Data Space
  - Loosely-Coupled
  - Full Redundancy
  - Reliable Multicast
  - End-to-End QoS (SOA)
  - Data-Centric Integration Bus
  - Substantially Less Application Code
- WIRE PROTOCOL INTEROPERABILITY**

# Healthcare Middleware – Integrated Clinical Environment

## How can we (?) use Open Standard IoT Software as a model ?

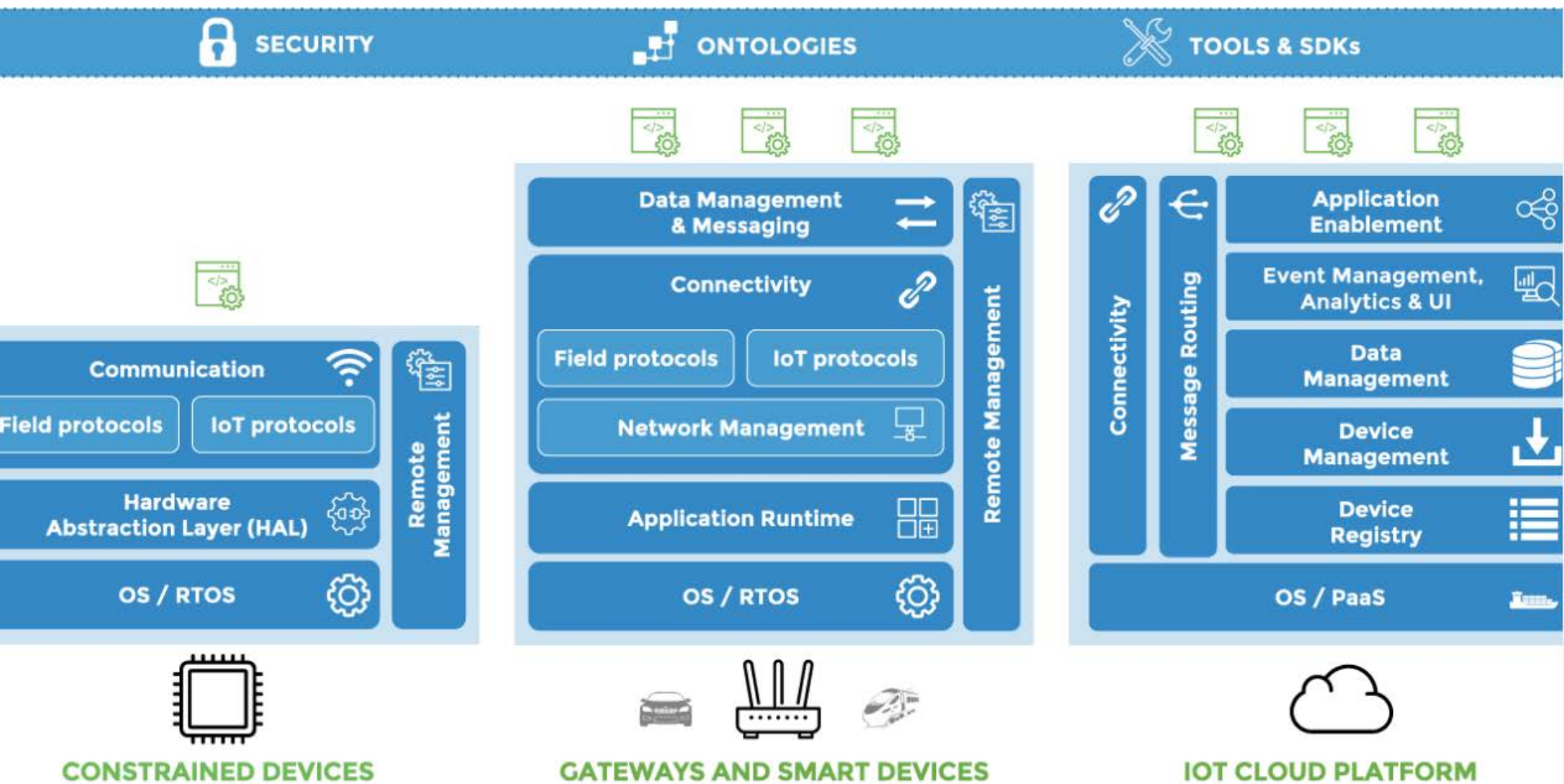



# PROOF OF CONCEPT

Response to White House Call for Ebola Management

<https://vimeo.com/111314176>

# Need for Integrated Healthcare Platforms?

# Ebola spurs rethinking of devices at MGH

By Carolyn Y. Johnson

GLOBE STAFF NOVEMBER 07, 2014

*You cannot buy a TV without a remote. You cannot buy a medical device with a remote. Dr Julian M Goldman (MGH/HMS) MD PnP*

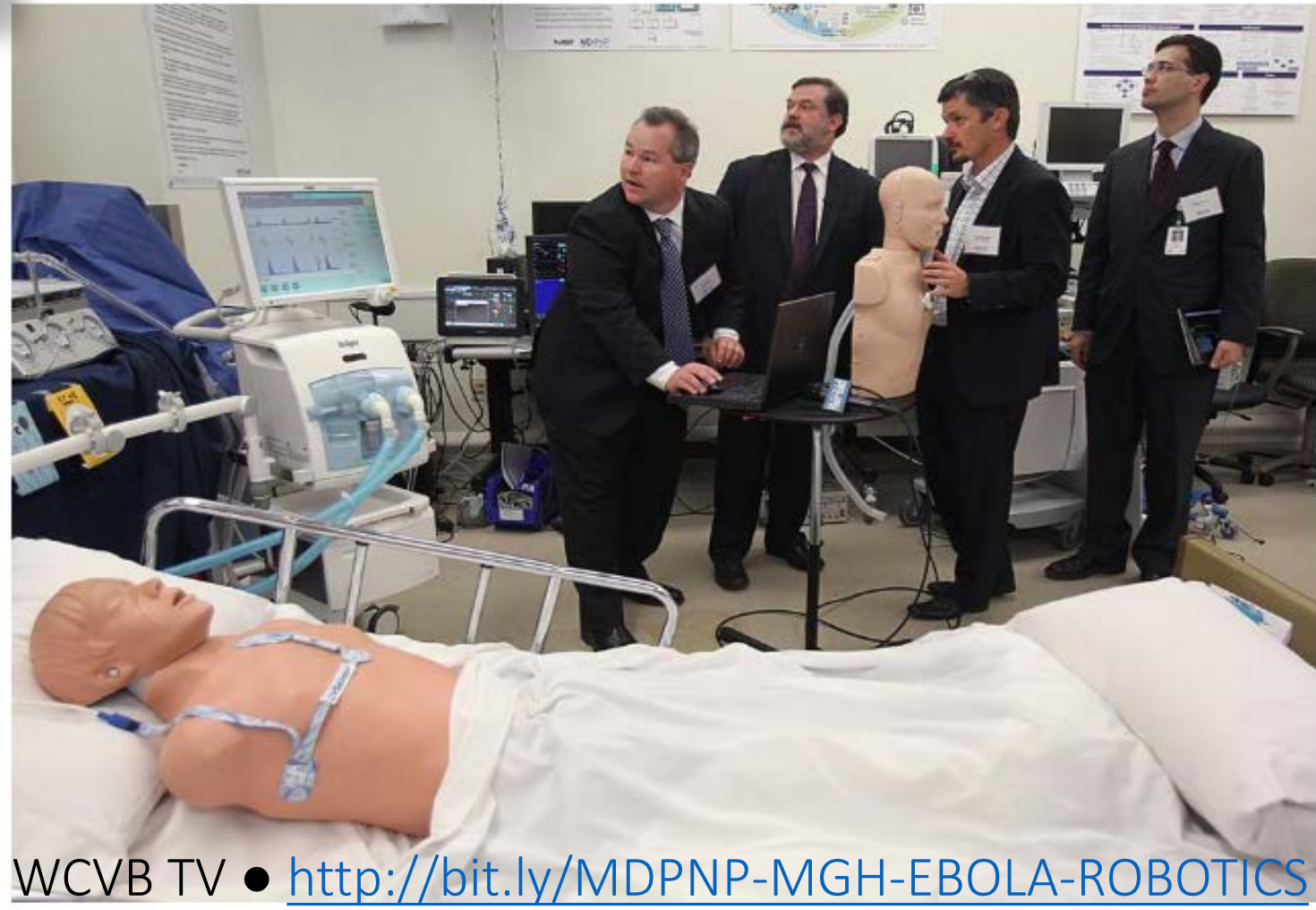

WCVB TV ● <http://bit.ly/MDPNP-MGH-EBOLA-ROBOTICS>

SUZANNE KREITER/GLOBE STAFF

Health officials demonstrated treating an Ebola patient remotely in a mock ICU. Pictured, left to right: Eric Lynn, Julian M. Goldman, Brian Russell, and Dave Arney.

National Coordinator of Ebola, IT, Dr. Kara Johnson  
Chief Technology Officer, Department of Health and Human Services, Boston, MA  
U.S. Medical Director, Program for Emerging and Re-emerging Infectious Diseases, Boston, MA  
U.S. Army of 111501 (Hospitality Services, Medical) 2014

# Robotics Community Responds to Safety of Ebola Workers

New cases for the week ending Oct. 14

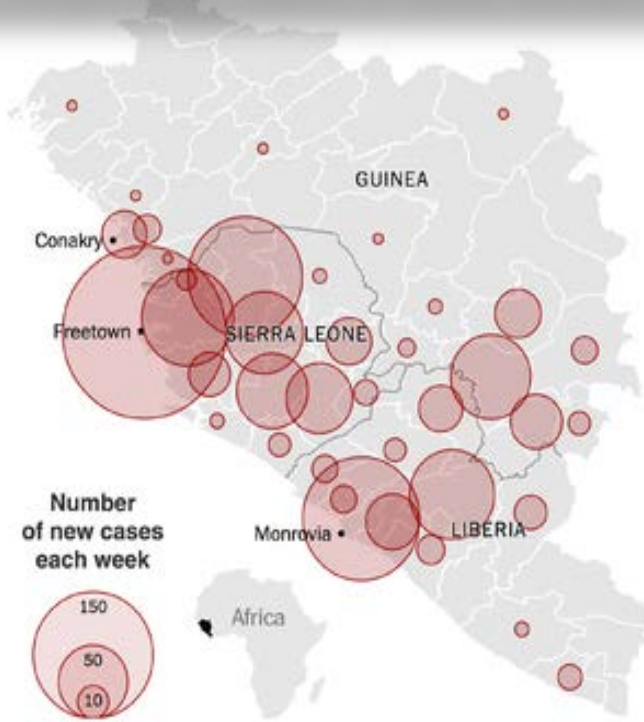
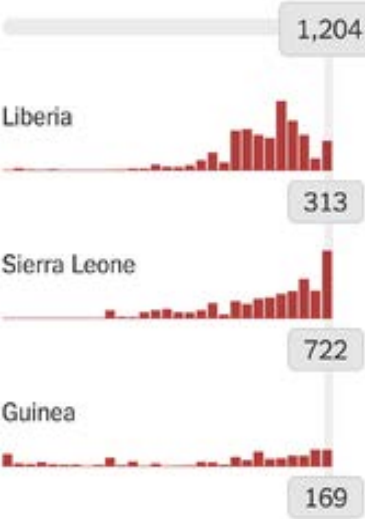

Bill and Gerry Brinton of Charles Creek Winery pose with Sonoma Valley Hospital (SVH, CA) CEO Kelly Mather to display the "Lisa" aka the Germ-Zapping Robot manufactured by Xenex (pulsed xenon UV disinfection technology to rapidly reduce germ loads). The Brintons donated the robot to the hospital (SVH).



# Robotic Tools in Infectious Diseases Management Need for Medical Device Interoperability Platform



# EBOLA

# COLLABORATORS

The collage includes the following logos and text:

- PARTNERS HEALTHCARE** (with tagline: FOUNDED BY BRIGHAM AND WOMEN'S HOSPITAL AND MASSACHUSETTS GENERAL HOSPITAL)
- MD PnP** (with tagline: Getting Connected for Patient Safety™)
- MGH 1811** (Massachusetts General Hospital logo)
- HARVARD MEDICAL SCHOOL**
- smiths medical** (with tagline: bringing technology to life)
- Lyntek**
- FEDERAL COMMUNICATIONS COMMISSION (FCC)**
- FDA** (Center for Devices and Radiological Health)
- DOCBOX**
- Zephyr**
- COVIDIEN**
- IEEE**
- GE Healthcare**
- RESPIRATORY MOTION INC.** (with tagline: INSPIRED INNOVATION)
- TATRC**
- WPI**
- PHILIPS**
- Dräger**
- intel**
- IIC MEMBER Industrial Internet CONSORTIUM**
- ISCHE**



**MD PnP MedTech Hackathon Open Medical Device and Data Integration Platforms to Support the Management of Ebola**

Will FDA drown medical device interoperability efforts through conventional regulatory acts?

Yes ?  No ?

Dr. Shuren received his B.S. and M.D. degrees from Northwestern University

under its Honors Program in Medical Education. He completed his medical internship at Beth Israel Hospital in Boston, his neurology residency at Tufts New England Medical Center, and a fellowship in behavioral neurology and neuropsychology at the University of Florida. He received his J.D. from the University of Michigan.



DEPARTMENT OF HEALTH & HUMAN SERVICES

Food and Drug Administration  
10903 New Hampshire Avenue  
Room 5447, Building 66  
Silver Spring, MD 20993-0002

November 3, 2014

Julian M. Goldman, MD  
Director, Medical Device Interoperability Program  
65 Lansdowne Street  
Cambridge, MA 02139

Dear Dr. Goldman,

Thank you for reaching out to the Center for Devices and Radiological Health (CDRH) via our Emergency Preparedness/Operations and Medical Countermeasures (EMCM) Program.

We understand that The Medical Device "Plug-and-Play" (MD PnP) Interoperability Program, under your coordination, has been asked by the White House Office of Science and Technology Program to mobilize resources among medical device manufacturers and the clinical community, so as to design and demonstrate proof of concept for an interoperable platform that would enable critical care of Ebola-infected patients in an isolation environment with reduced exposure to health care workers.

FDA recognizes the importance of implementing strategies that minimize direct exposure of clinical personnel to patients infected with Ebola virus. We understand that MDPNP, along with its collaborators, are developing potential approaches that would include comprehensive data access and potential remote control of medical devices in the isolation environment, thereby reducing the risk of healthcare worker exposure to the virus.

CDRH recognizes the importance of these efforts and is ready and willing to collaborate with you, the clinical community and your industry partners to demonstrate the potential of this technology in serving this particular public health emergency. We are eager to observe the demonstration taking place Friday November 7th for OSTP, and we look forward to participating in the development of next steps with MDPNP and your medical device partners so as to do our part in enabling advancement of technology that can protect our healthcare workers who put themselves on the front line to promote the public health mission.

Sincerely,

A handwritten signature in black ink, appearing to read "Jeffrey Shuren".

Jeffrey Shuren, M.D., J.D.  
Director  
Center for Devices and  
Radiological Health

Participation of the US FDA  
CDRH was a powerful  
incentive for medical device  
manufacturers to explore  
innovative medical  
technology solutions,  
especially those benefiting  
from interoperability  
between manufacturers



# US Federal HIT Goals from the ONC, US HHS

F  
D  
A

**Collect**

**Goal 1: Expand Adoption of Health IT**



**Goal 2: Advance Secure and Interoperable Health Information**

**Share**

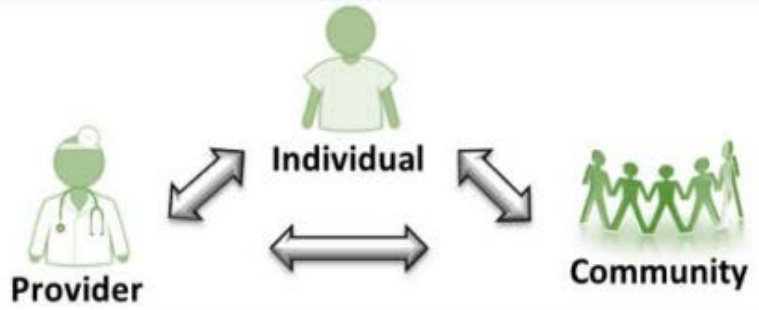

**Goal 3: Strengthen Health Care Delivery**

**Goal 4: Advance the Health and Well-Being of Individuals and Communities**

**Use**



**Goal 5: Advance Research, Scientific Knowledge, and Innovation**





# Device, data, diagnostics

*The Quest for Convergence of Platform and Interoperable Standards*

AWARDS, PEOPLE

## Doudna awarded Japan Prize for invention of CRISPR gene editing

By Robert Sanders, Media relations | FEBRUARY 2, 2017



Emmanuelle Charpentier ▀ Jennifer Doudna

## Pac-Man-like CRISPR enzymes have potential for disease diagnostics

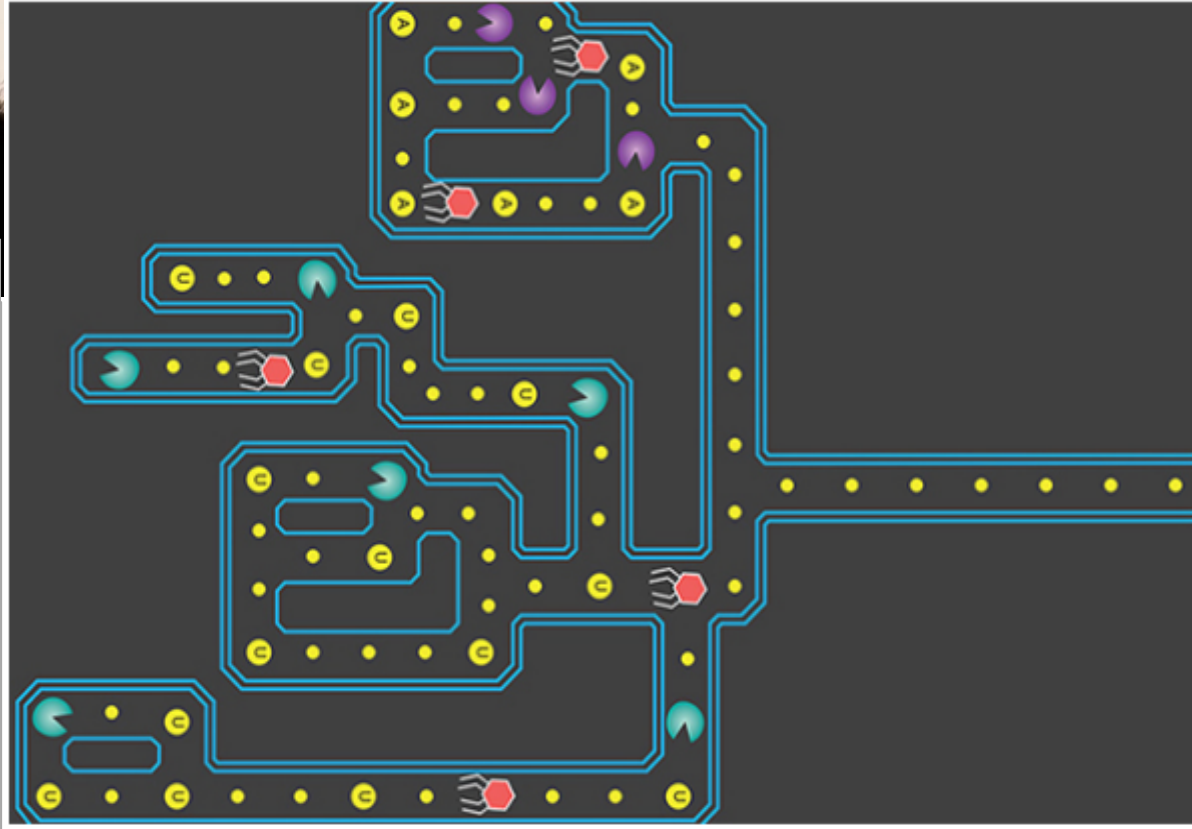

Researchers have described 10 new CRISPR enzymes that, once activated, behave like Pac-Man to chew up RNA in a way that could be used as sensitive detectors of infectious viruses. The new CRISPR enzymes are variants of a CRISPR protein, Cas13a, which could be used to detect specific sequences of RNA, such as from a virus. The researchers showed that once CRISPR-Cas13a binds to its target RNA, it begins to indiscriminately cut up all RNA, easily cutting RNA linked to a reporter molecule, making it fluoresce to allow signal detection. Such a system could be used to detect any type of RNA, including RNA distinctive of cancer cells.

# US Healthcare: A Losing Battle? Bad Habits Die Hard

## Life expectancy vs. health expenditure over time (1970-2014)

Our World in Data

Health spending measures the consumption of health care goods and services, including personal health care (curative care, rehabilitative care, long-term care, ancillary services and medical goods) and collective services (prevention and public health services as well as health administration), but excluding spending on investments. Shown is total health expenditure (financed by public and private sources).

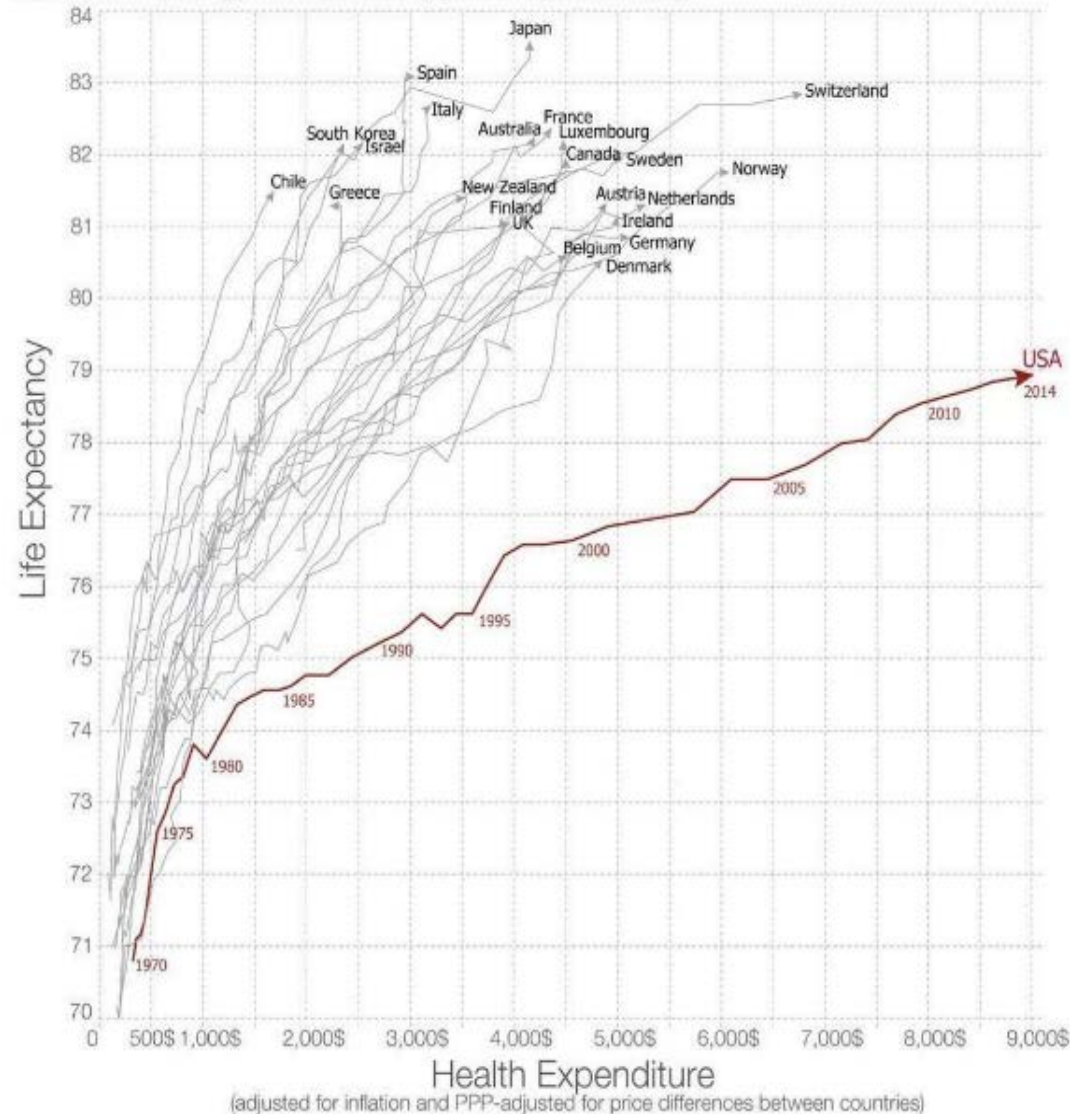

## Changing eating habits in the US

Percent change in calorie consumption by food category, 1970-2010

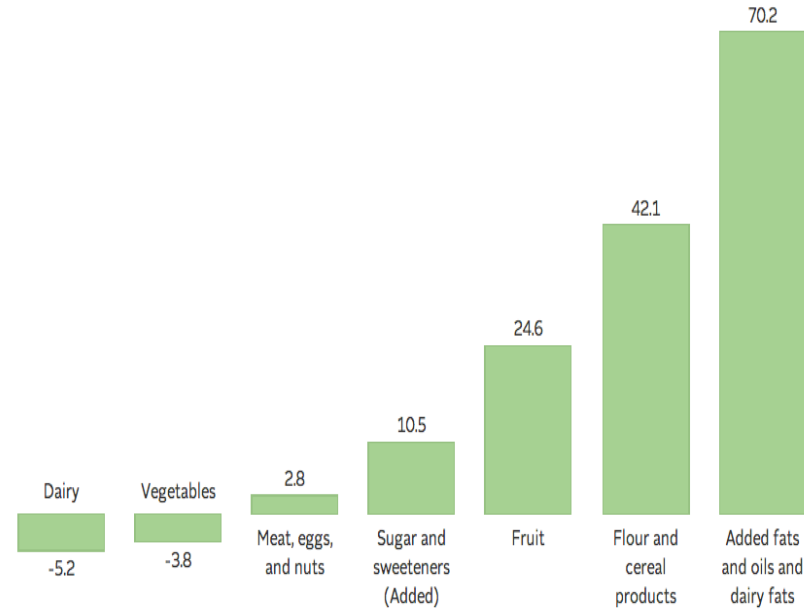

Source: USDA



# IS HEALTHCARE A HUMAN RIGHT? IS IT FOR THE BILLIONS ?

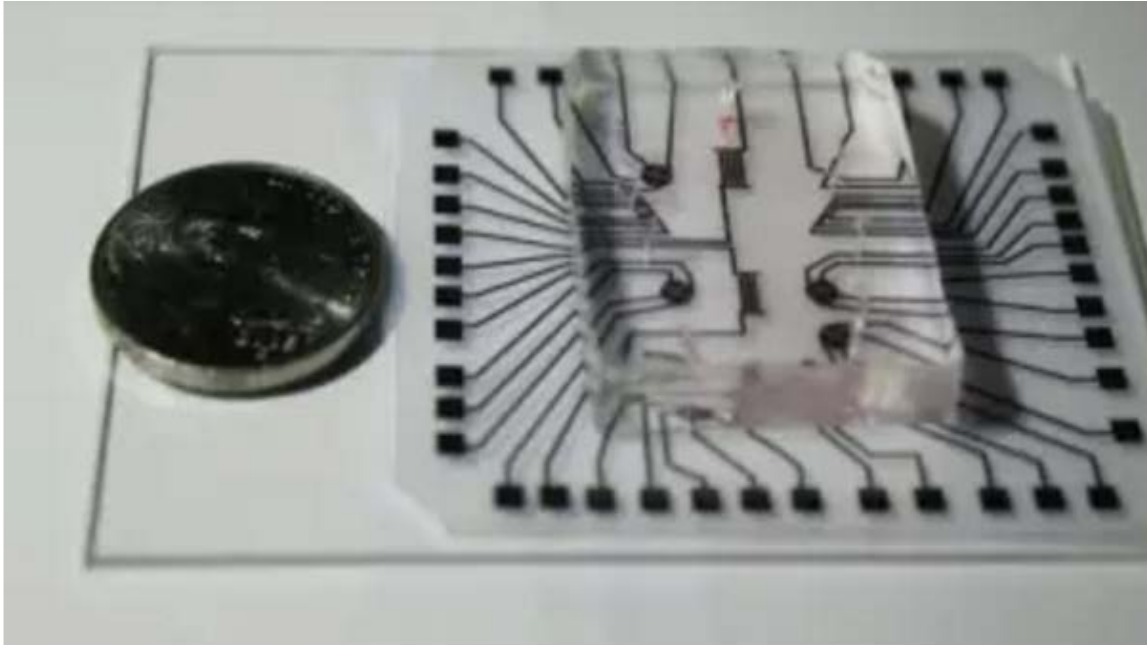

*This device costs one cent to make and could help deliver critical diagnostic care to remote, impoverished areas of the globe. (Image courtesy of Stanford.)*

Multifunctional, inexpensive, and reusable nanoparticle-printed biochip for cell manipulation and diagnosis

Rahim Esfandarypour<sup>a,b</sup>, Matthew J. DiDonato<sup>c</sup>, Yuxin Yang<sup>d</sup>, Naside Gozde Durmus<sup>a,b</sup>, James S. Harris<sup>d</sup>, and Ronald W. Davis<sup>a,b,1</sup>

<http://www.pnas.org/content/114/8/E1306.abstract>

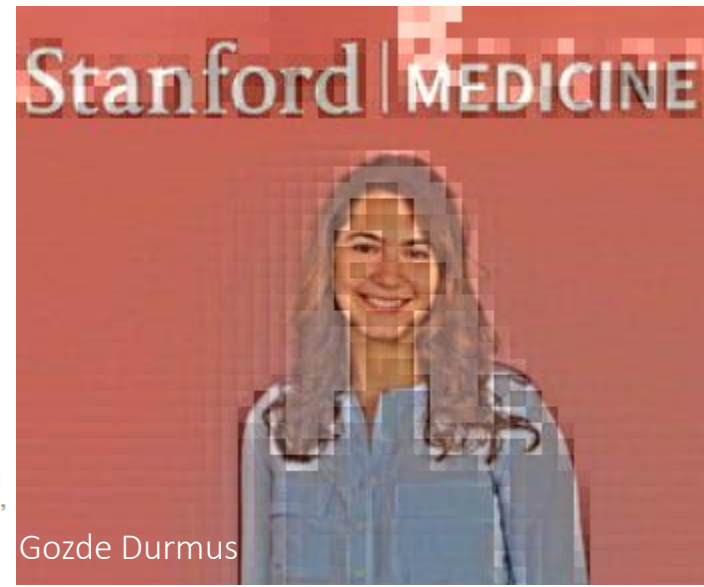

Gozde Durmus

# World Sugar Trade (2010/2011)

[www.nytimes.com/2016/09/13/well/eat/how-the-sugar-industry-shifted-blame-to-fat.html?\\_r=0](http://www.nytimes.com/2016/09/13/well/eat/how-the-sugar-industry-shifted-blame-to-fat.html?_r=0)

[www.npr.org/sections/thetwo-way/2016/09/13/493739074/50-years-ago-sugar-industry-quietly-paid-scientists-to-point-blame-at-fat](http://www.npr.org/sections/thetwo-way/2016/09/13/493739074/50-years-ago-sugar-industry-quietly-paid-scientists-to-point-blame-at-fat)

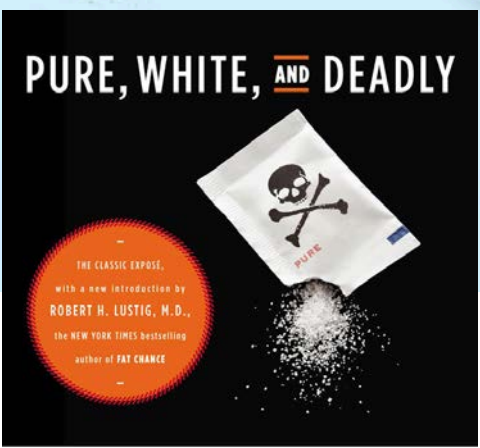
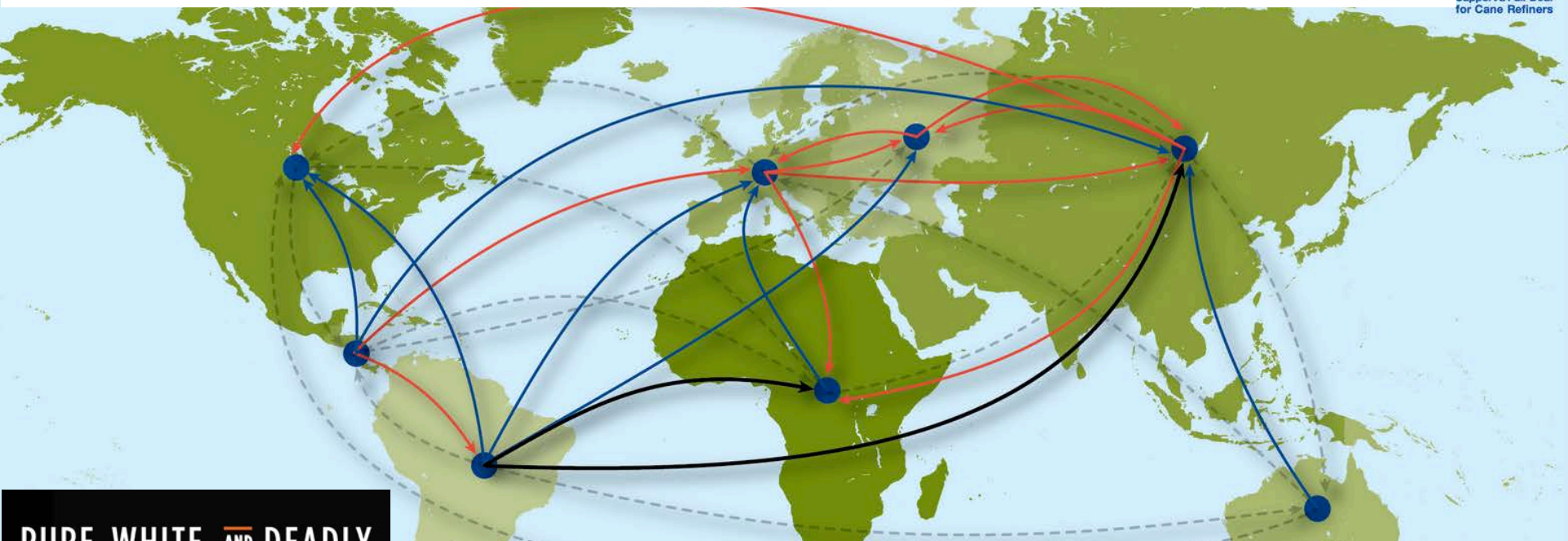

How Sugar Is Killing Us and  
What We Can Do to Stop It



John Yudkin

The sugar industry paid scientists in the 1960s to play down the link between sugar and heart disease and promote saturated fat as the culprit instead, newly released historical documents show.

<http://jamanetwork.com/journals/jamainternalmedicine/article-abstract/2548255>

The documents show that a trade group called the Sugar Research Foundation, known today as the Sugar Association, paid three Harvard scientists the equivalent of about \$50,000 in today's dollars to publish a 1967 review of research on sugar, fat and heart disease. The studies used in the review were handpicked by the sugar group, and the article, which was published in the prestigious New England Journal of Medicine, minimized the link between sugar and heart health and cast aspersions on the role of saturated fat.

[www.ncbi.nlm.nih.gov/pubmed/5339699](http://www.ncbi.nlm.nih.gov/pubmed/5339699)

# Insulin Resistance and Cancer

ILP Signaling and Cancer

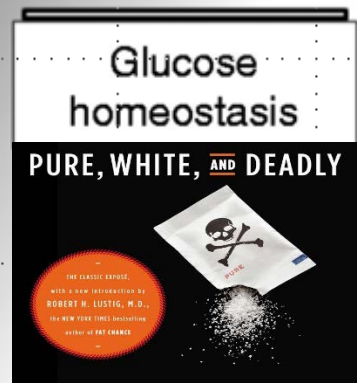
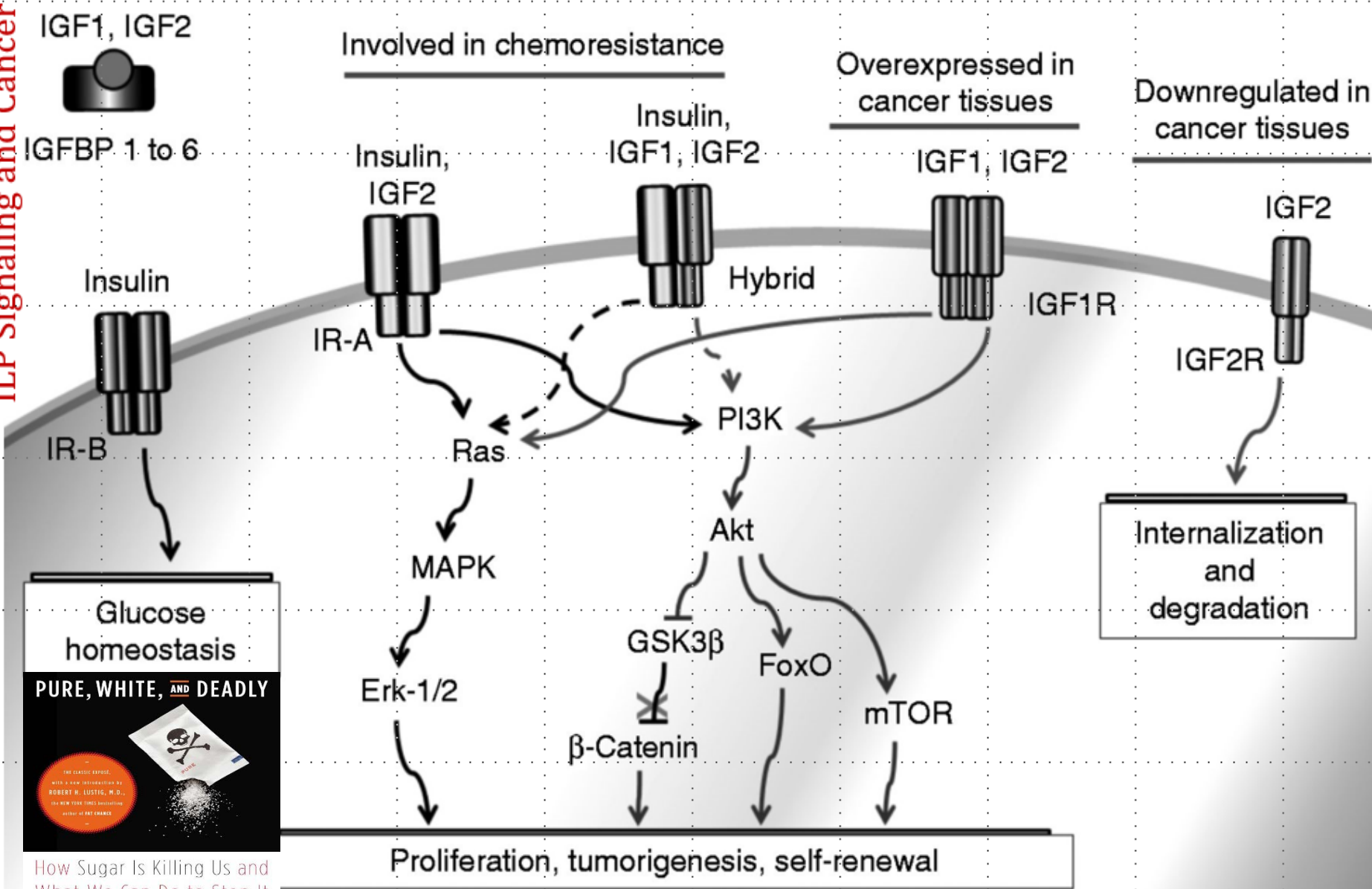

How Sugar Is Killing Us and What We Can Do to Stop It

John Yudkin

**How Sugar is Killing Us**

[www.ncbi.nlm.nih.gov/pubmed/23207292](http://www.ncbi.nlm.nih.gov/pubmed/23207292)

# DIABETES – The next medical IoT Focus

## Google, DexCom to Make Glucose Monitoring Devices for Diabetes Patients

by Robin Sinha, 13 August 2015



Soon after the announcement of its new CEO Sundar Pichai and a holding company called Alphabet, the Google Life Sciences team has teamed up with a healthcare firm DexCom to build blood glucose monitoring devices for diabetes patients that are smaller and less expensive than current technologies.

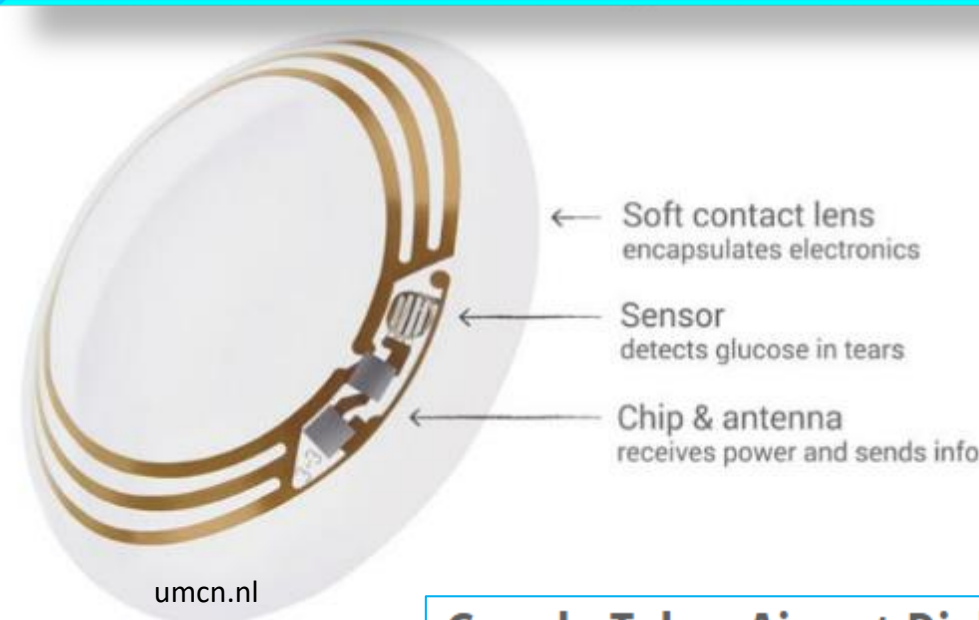

umcn.nl

## Google Takes Aim at Diabetes with Big Data, Internet of Things

By Jennifer Bresnick on August 31, 2015



Freshly revitalized after Google's much-discussed reorganization under the **Alphabet** umbrella, the tech giant's life science team is once again **planning to tackle diabetes** with the help of big data analytics and innovative Internet of Things technologies.

With the formation of a new partnership that enlists the aid of the **Joslin Diabetes Center** and Sanofi, a multinational pharmaceutical developer, Google hopes to reduce the burden of Type 1 and Type 2 diabetes on both patients and providers.



# BLOOD-FREE NON-INVASIVE BLOOD GLUCOSE

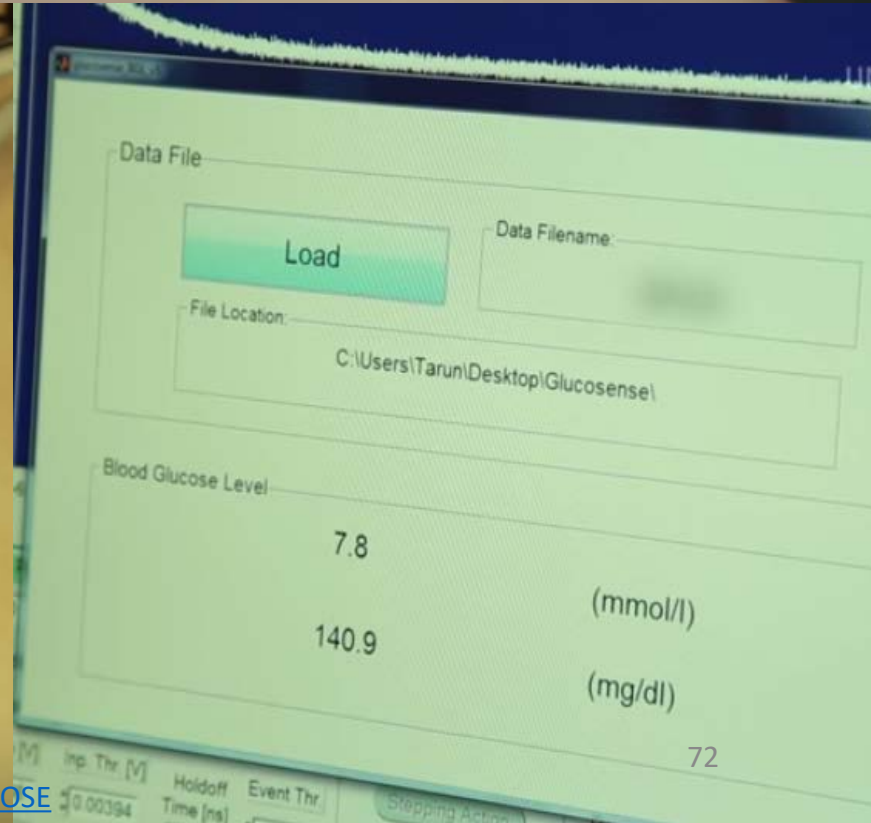



# BLOOD-FREE NON-INVASIVE BLOOD HEMOGLOBIN ??

Laser excitation of oxy-hemoglobin generates highly specific resonance (Raman spectra) which could be exploited in the development of non-invasive tool to determine hemoglobin.

*This statement is made by the author. It is merely a suggestion.*

**TRUEHb** For ultra-convenient  
**HEMOMETER** hemoglobin measurement



Wrig Nanosystems, a medical technology startup company which develops and markets a hemoglobin measurement device, has attracted financial interest from different investors in the product. The company has made an investment of up to 15 cr to commercialise and further develop the product and Avendus Wealth Management acted as the advisor to Wrig on this deal.

The list of investors includes Flipkart co-founders Sachin and Binny Bansal, Malvinder and Shivinder Singh (former Ranbaxy and Fortis promoters), Gurpreet Singh (Round Glass Partners)<sup>73</sup> and others.

# Optics for the Masses

The Peek Retina adapter is being developed through a collaboration between the University of Strathclyde, where Dr Mario Giardini heads the engineering design; the London School of Hygiene & Tropical Medicine; and the Glasgow Centre for Ophthalmic Research of NHS Greater Glasgow and Clyde.

- View the retina with high quality imaging
- See cataracts clearly for classification
- Simulates a patient's eyesight on screen
- Visual acuity tests for eyesight
- Colour and contrast tests

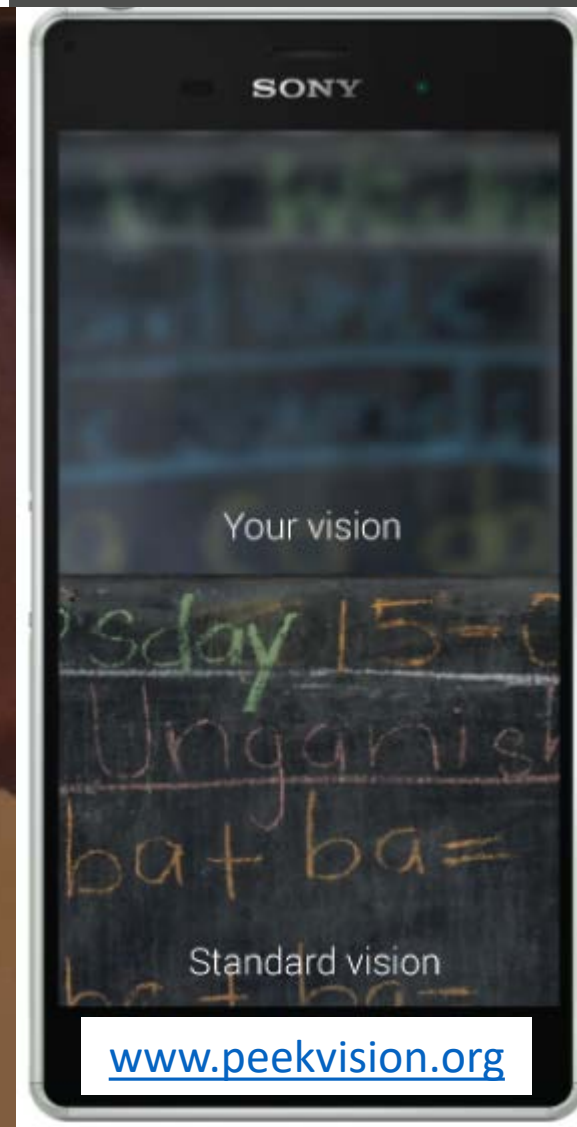

# OPTICIAN'S CLINIC-IN-A-POCKET



A woman from Nakuru, Kenya, having a cataract scan with the Peek smartphone tool. This portable eye testing kit can diagnose eye problems in remote areas, where access to clinics is limited. ©Peek

**What we hope is that it will provide eye care for those who are the poorest of the poor**

Dr Andrew Bastawrous, London School of Hygiene and Tropical Medicine

[www.bbc.com/news/health-22553730](http://www.bbc.com/news/health-22553730)

## What the phone app can do for eyes

Peek can diagnose a vast range of eye problems, blindness and vision impairments,

- [Glaucoma](#)
- Cataracts
- Macular degeneration
- [Diabetic retinopathy](#)
- Other retinal and optic nerve diseases.



Dr Leslie Saxon, University of Southern California

PHONE ECG DETECTS  
IRREGULAR HEARTBEAT

# CARDIAC ARRHYTHMIA DIAGNOSIS & REPORTING CARDIOLOGIST-in-a-POCKET



## Normal Sinus Rhythm



Circular pathways in the heart conduction system is a common cause of arrhythmias

## Arrhythmic Rhythm

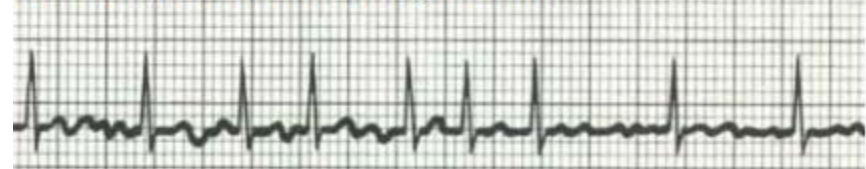

[www.seas.upenn.edu/sunfest/docs/slides/MALAMASPETER.pdf](http://www.seas.upenn.edu/sunfest/docs/slides/MALAMASPETER.pdf)

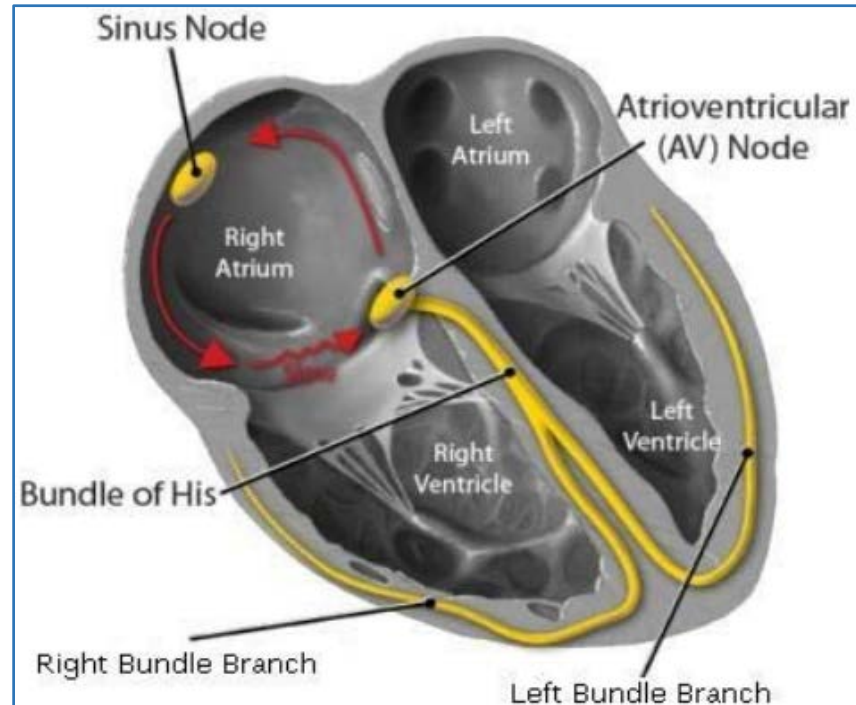
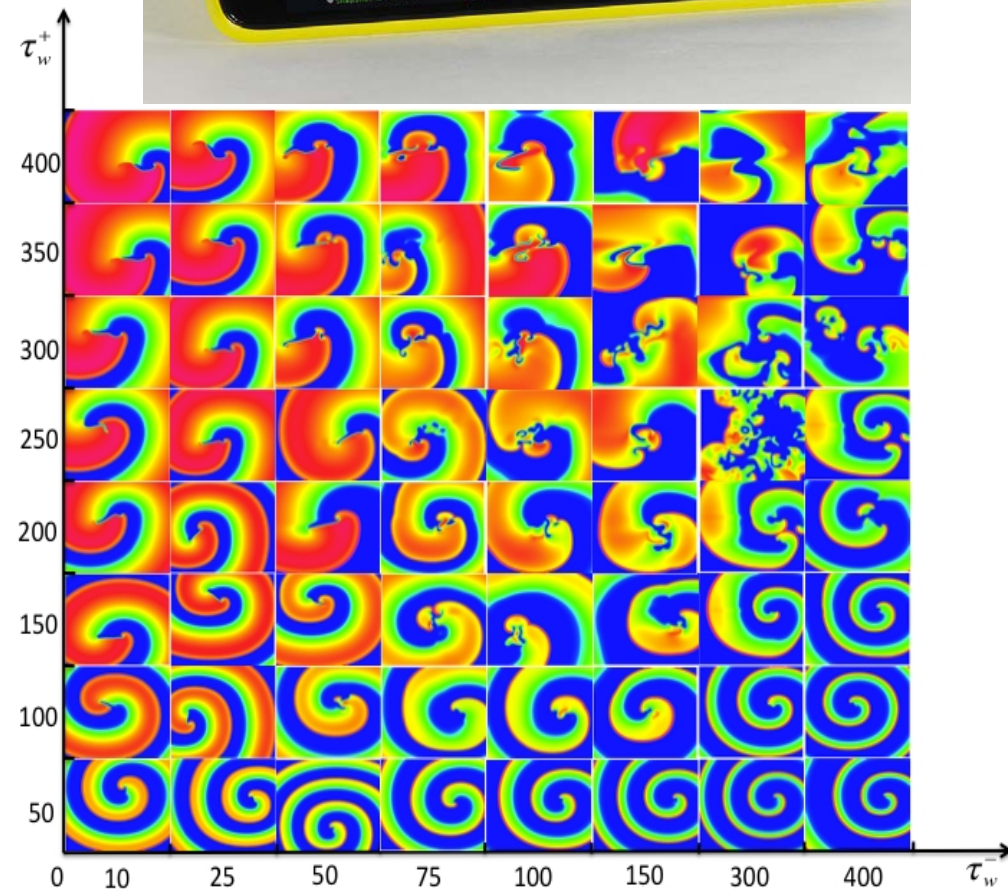

# MIT News

ON CAMPUS AND AROUND THE WORLD



MIT Media Lab spinout Cardio has developed a mobile app that uses a smartphone camera to detect facial signs of a heart arrhythmia associated with strokes.

Courtesy of Cardio

App screens for arrhythmia using smartphone

# Samsung's NeuroLogica digital X-ray system

# DISRUPTION

By Emily Wasserman

Samsung's NeuroLogica unit snagged an FDA OK for its digital radiography system, giving the company a boost as it aims for a top spot in the medical device imaging market.

The devicemaker's GC85A ceiling digital X-ray system adds to its expanding suite of products, which includes its mobile digital GM60A, the U-arm digital GU60A and the ceiling digital GC80. The device includes wireless, lightweight detectors, a portable grid, and smart features that allow operators to position the entire system with one touch and work with compatible Samsung equipment, the company said in a statement.

"The Samsung GC85A represents NeuroLogica's latest commitment to introducing user- and patient-centric innovation to healthcare to provide fast, easy and accurate diagnoses," David Webster, NeuroLogica's chief marketing officer and VP of global sales, said in a statement. "The system's superior image quality and ease of control will enable users to experience a new level of efficiency with a DR system designed for streamlined operation."



*Samsung's GC85A system--Courtesy of Samsung*



# Detection of Parkinson's Disease using a Smart Phone

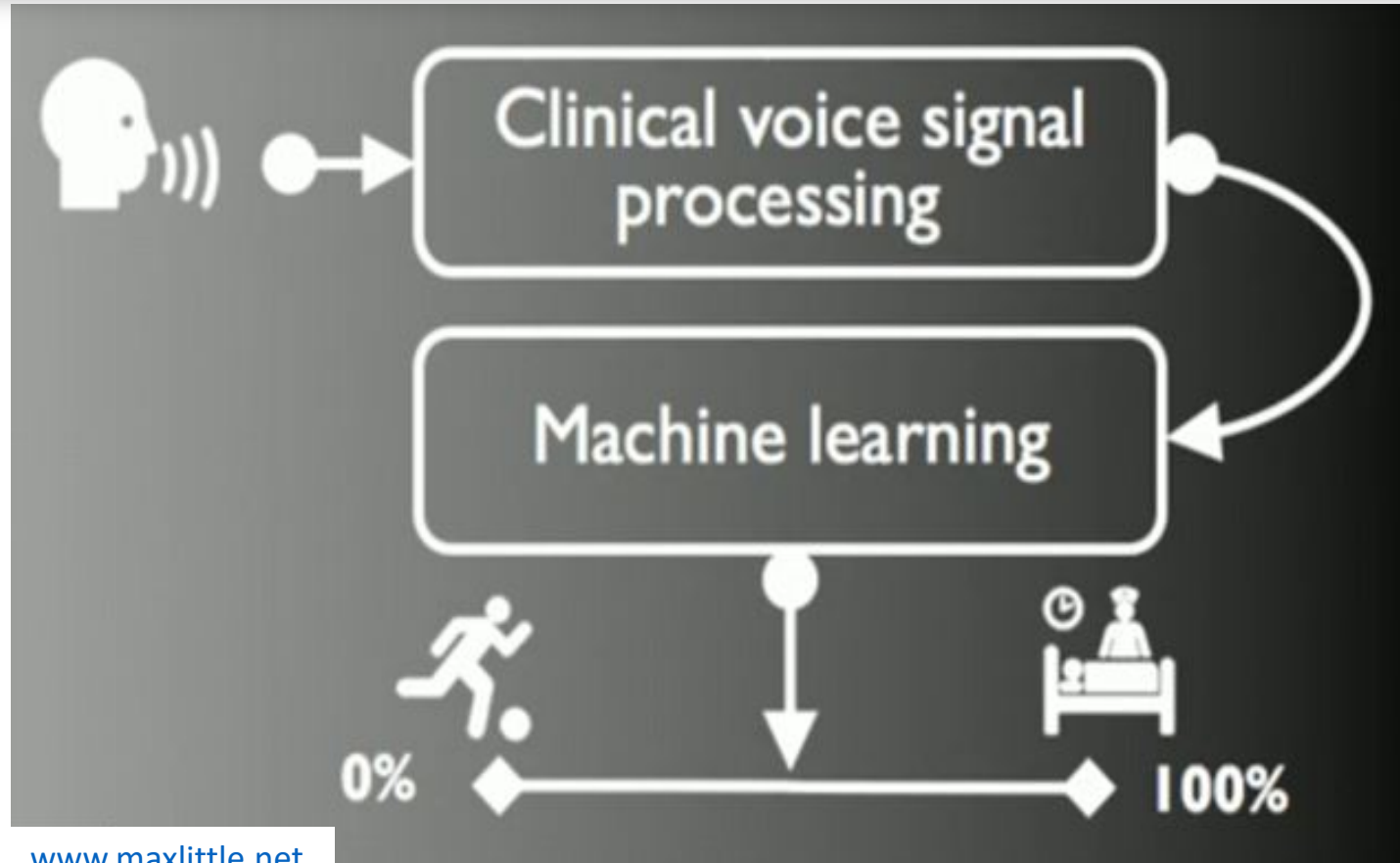

Acoustic signal processing data may be used to detect Parkinson's Disease with a smartphone or predict torrential rainfall or used in hydrogeomorphology apps.



2.5 million falls 2013  
734,000 hospitalized  
25,500 died from fall  
\$34 billion direct cost

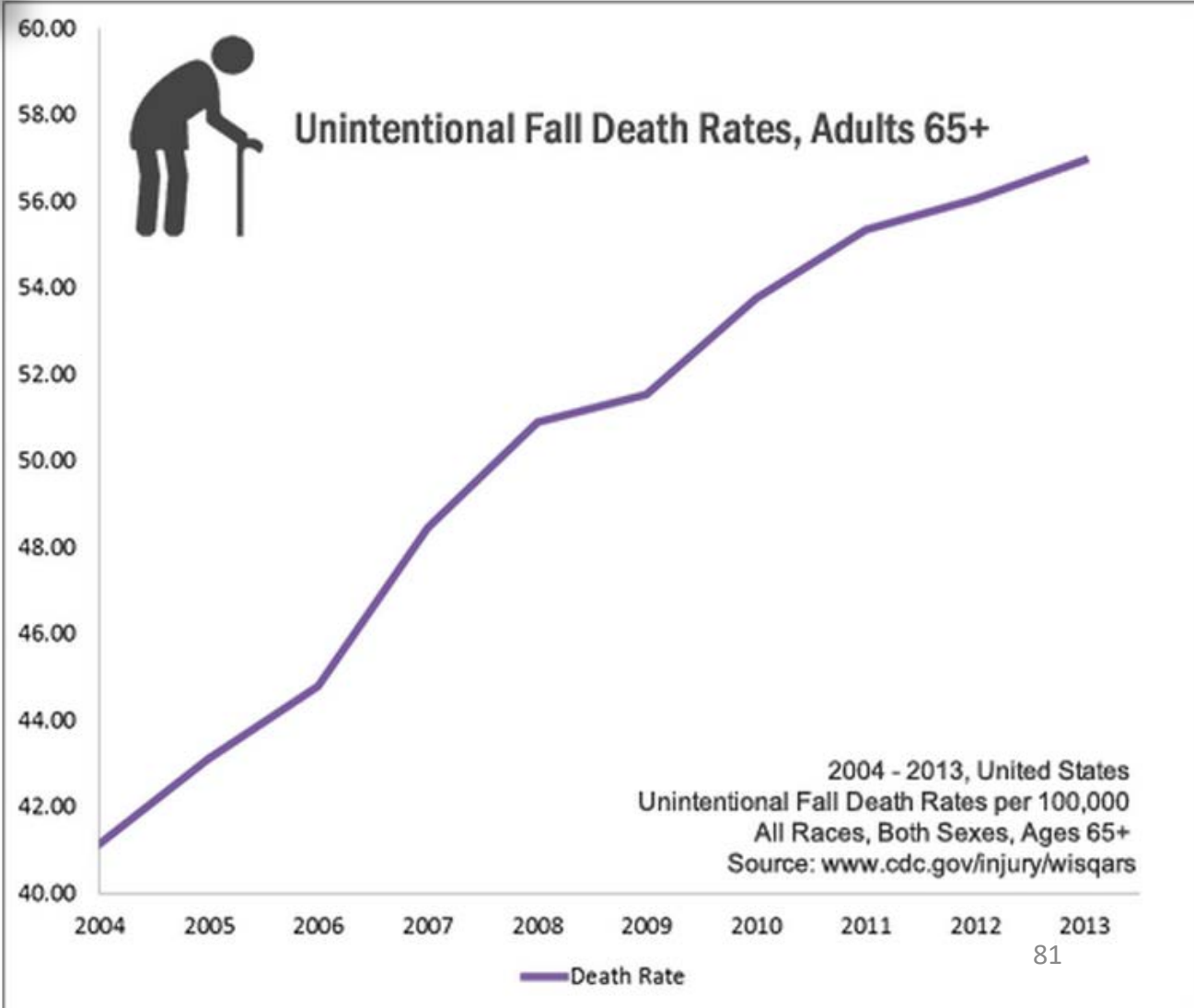

# Professor Dina Katabi (MIT) presenting RF Reflection to President Obama (White House Demo, 4 August 2015)

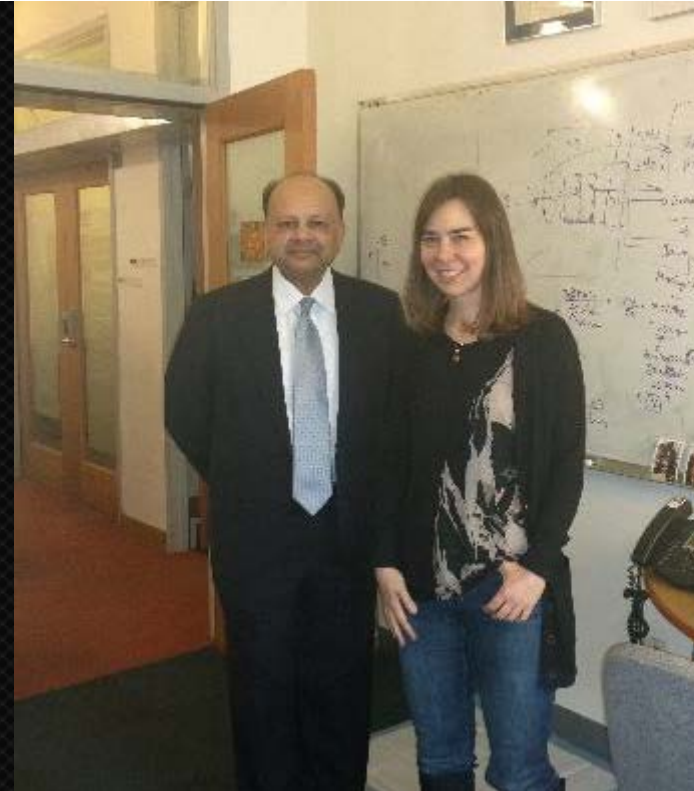

President Obama invites MIT entrepreneurs to give demo at the White House <http://bit.ly/President-Obama-with-Dina-Katabi>

<http://newsoffice.mit.edu/2015/president-obama-meets-mit-entrepreneurs-white-house-demo-day-0806>

# Fall Detection – Wire less, Sensor less, Without Wearables

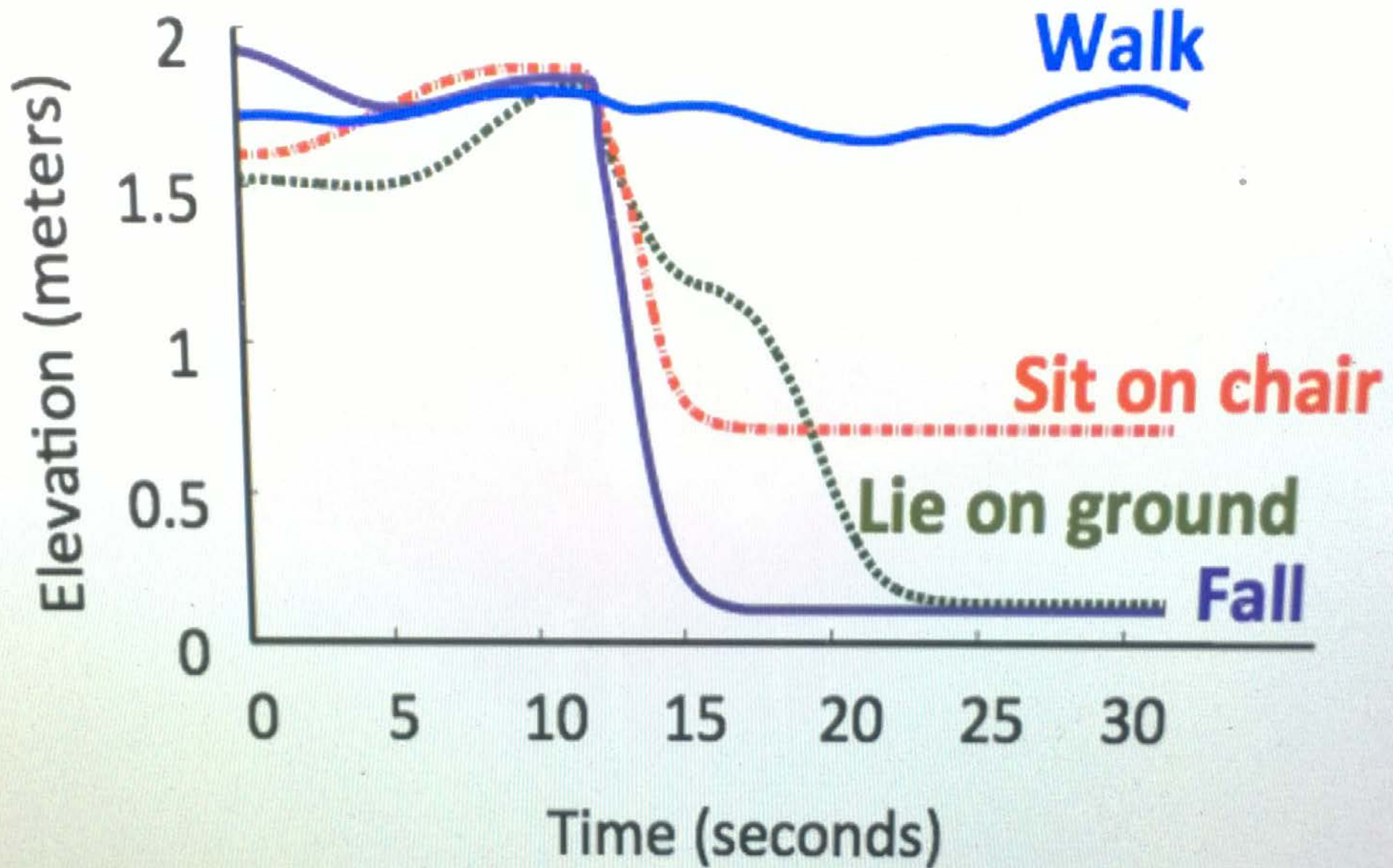

Many more innovations are on the way ...

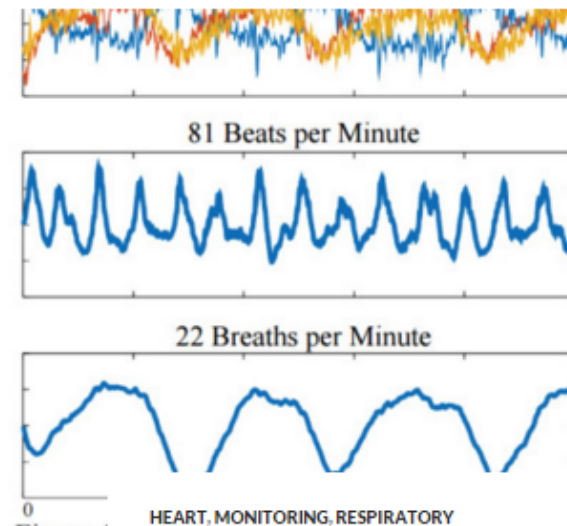

Figure 1

HEART, MONITORING, RESPIRATORY

## PHONE TRACKS HEALTH WITHOUT WEARABLE SENSORS

NOVEMBER 14, 2015 LISAWEINER



[Javier Hernandez Rivera](#) of [Rosalind Picard's Affective Computing Group](#) at MIT is developing a health monitoring phone that does not require a wearable. [BioPhone](#) derives biological signals from a phone's accelerometer, which the team says captures small body movements that result from one's heart beating and chest rising and falling.

Hernandez said that BioPhone is meant to gather data during still moments, simplifying the capture of small vibrations without having to account for many body movements. He believes that this can detect stress, which could trigger the phone to provide breathing exercises, or notify a loved one to call.

12 subjects sat, stood, and lied down, before and after pedaling a bike, with a smartphone in their pocket. To compare results, they wore sensors to capture heart and breathing rates. Heart rates reported by smartphone data alone were off by 1 beat per minute, and breathing rates were off by 1/4 of a breath per minute.

# Remote Thought-Controlled Telepresence Robots directed by humans with motor neuron paralysis



1:18 / 1:46

This is not a new problem. It has been recognized for a couple decades.

Healthcare tools may need an open platform to curate and catalyze data interoperability between devices to better treat the patient, in real-time.

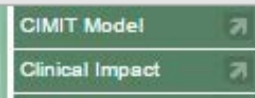

MIT is one of the four institutions that came together in 1998 to found CIMIT. In addition to the CIMIT-funded projects MIT researchers have pursued, CIMIT and MIT have been working together through guest faculty support of its Health Science and Technology Program to provide meaningful training in medical device development for graduate students.

The Medical Device “Plug-and-Play” (MD PnP) Interoperability Program was established in 2004 to lead the adoption of open standards and technology for medical device interoperability to support clinical innovation. The term “PnP” was adopted because the required technology infrastructure has many elements in common with the plug-and-play approach used in other computer-based systems. The program is affiliated with Massachusetts General Hospital (MGH), CIMIT (Center for Integration of Medicine and Innovative Technology), and Partners HealthCare Information Systems, with additional support from TATRC (U.S. Army Telemedicine & Advanced Technology Research Center). Having evolved from the OR of the Future program at MGH, the MD PnP program remains clinically grounded.

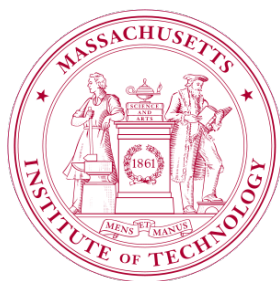

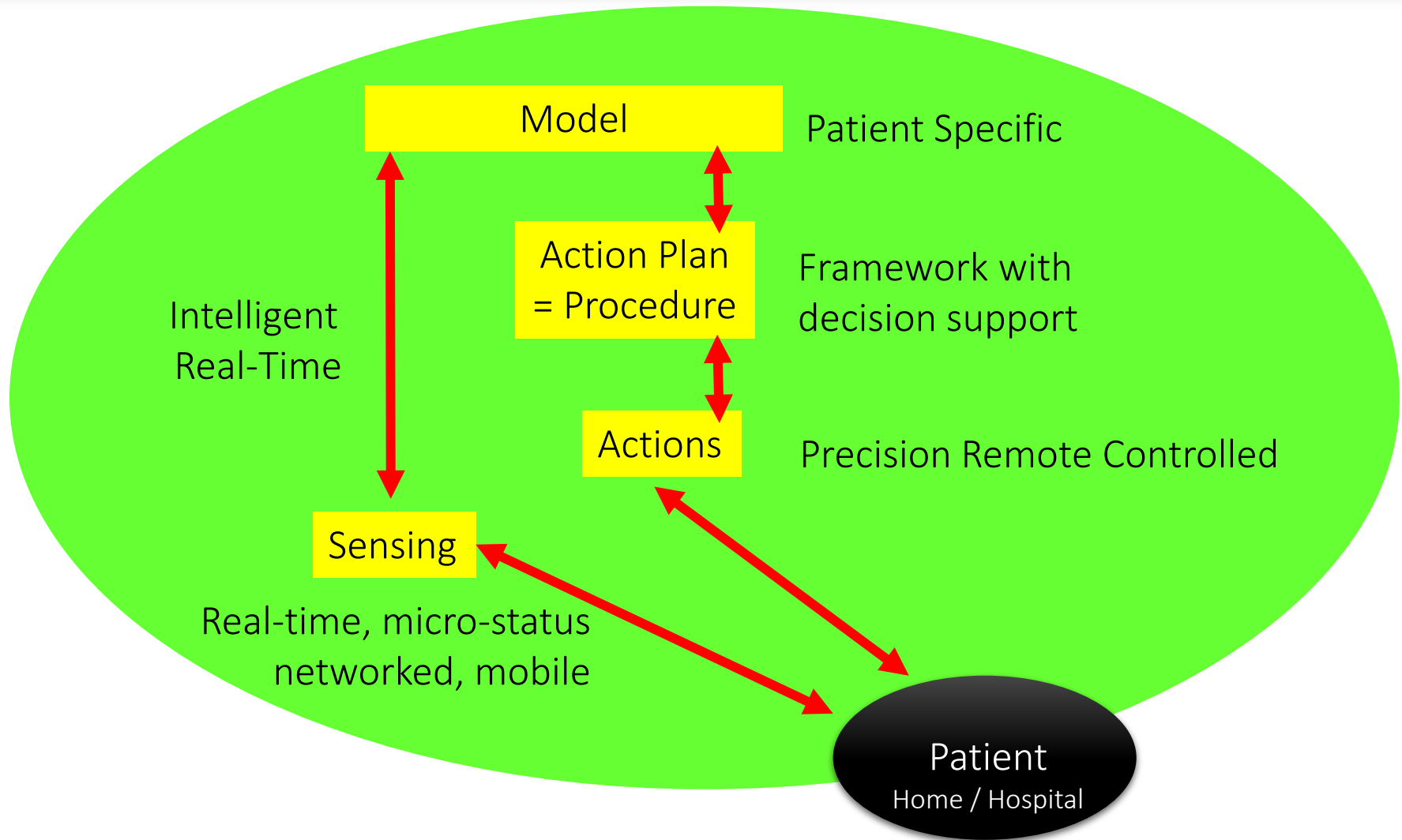



## Medical Device "Plug-and-Play" Interoperability Program working on "safe interoperability™" to improve patient safety

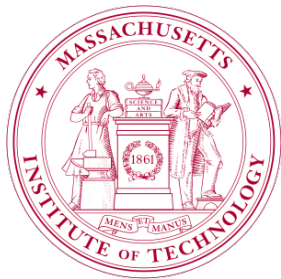

The CIMIT MD PnP Lab opened in May 2006 to provide a vendor-neutral “sandbox” to evaluate the ability of candidate interoperability solutions to solve clinical problems, to model clinical use cases (in a simulation environment), to develop and test related network safety and security systems, and to support interoperability and standards conformance testing.



At the CIMIT Innovation Congress in November 2007, Dr. Julian Goldman demonstrated how patient safety could be improved by synchronization of the x-ray exposure with the ventilator during surgery.

# OpenICE Test Bed

Now available to IIC Members

Integrated Clinical Environment

[WWW.MDPNP.ORG](http://WWW.MDPNP.ORG)

[www.openice.info](http://www.openice.info)

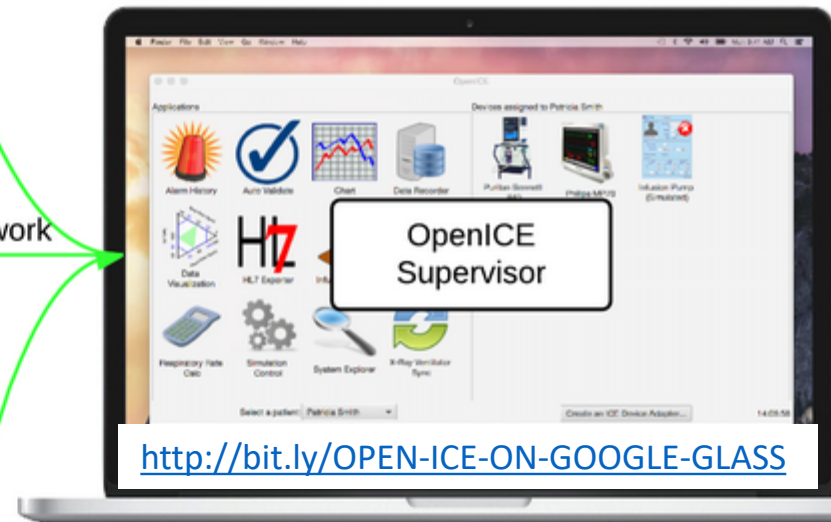
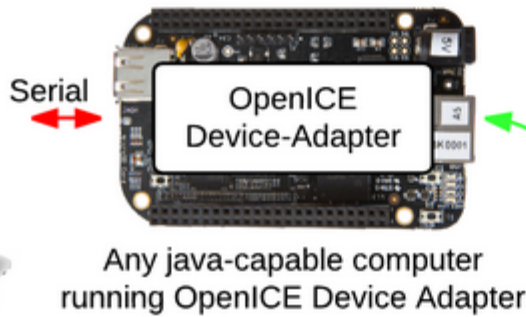

Any java-capable computer running OpenICE Supervisor



OpenICE Device Simulator running on any computer on the network

[www.openice.info/demo.html](http://www.openice.info/demo.html)

Content restricted to IIC Members  
Not for External Publication



Shoumen Datta, Gary Gottlieb and Julian Goldman



# Is FACE a useful guide for healthcare platforms?

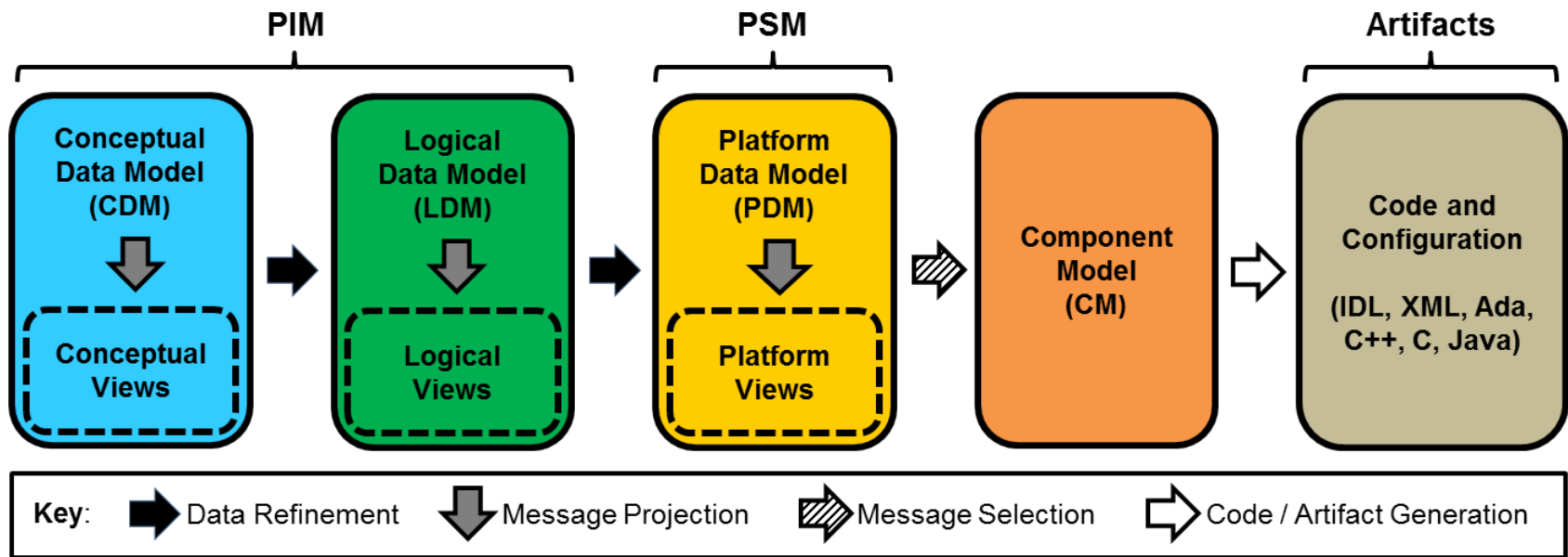

- Data and message models aligned with OMG Model Driven Architecture™
- Addition of the Component (UoP) model allows component integration with messages and data elements in the Platform Model
- Supports definition and potentially auto-generation of code and other artifacts

# IEEE Standards Help Enable Medical Devices

## Standard: IEEE 11073-10419

**What The Standard Does:**  
It specifies the use of specific term codes, formats, and behaviors in telehealth environments promoting interoperability. This standard defines a common core of communication functionality for personal health insulin pumps.

**Benefit to patient**  
- Data can be easily sent to clinician  
- The ease of interoperability and integration of multi-vendor products.

**Benefit to provider**  
- Ability to monitor patient biometrics and track trends, which may result in more efficient care and a quicker recovery.

## Standard: IEEE 11073-10424

**What The Standard Does:**  
It specifies the use of specific term codes, formats, and behaviors in telehealth environments promoting interoperability. This standard defines a common core of communication functionality for personal health sleep apnea equipment.

**Benefit to patient**  
- Data can be easily sent to clinician  
- The ease of interoperability and integration of multi-vendor products.

**Benefit to provider**  
- Ability to monitor patient biometrics and track trends, which may result in more efficient care and a quicker recovery.

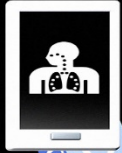
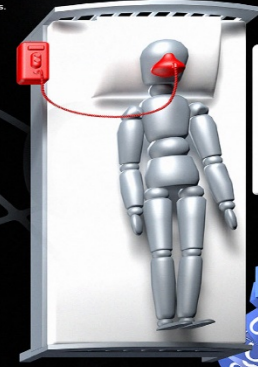
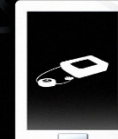
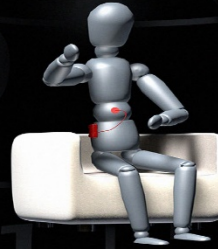
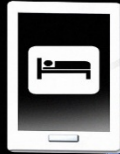
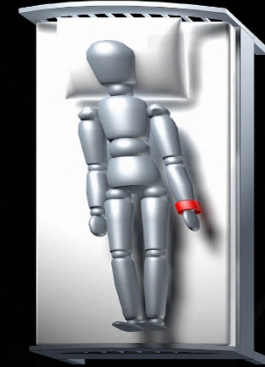

## Standard: IEEE 11073-10423

**What The Standard Does:**  
It specifies the use of specific term codes, formats, and behaviors in telehealth environments promoting interoperability. This standard defines a common core of communication functionality for personal health sleep monitors.

**Benefit to patient**  
- Data can be easily sent to clinician  
- The ease of interoperability and integration of multi-vendor products.

**Benefit to provider**  
- Ability to monitor patient biometrics and track trends, which may result in more efficient care and a quicker recovery.

## Standard: IEEE 11073-10417

**What The Standard Does:**  
It specifies the use of specific term codes, formats, and behaviors in telehealth environments promoting interoperability. This standard defines a common core of communication functionality for personal health glucose meters.

**Benefit to patient**  
- Data can be easily sent to clinician  
- The ease of interoperability and integration of multi-vendor products.

**Benefit to provider**  
- Ability to monitor patient biometrics and track trends, which may result in more efficient care and a quicker recovery.

## Standard: IEEE 11073-10441

**What The Standard Does:**  
It specifies the use of specific term codes, formats, and behaviors in telehealth environments promoting interoperability. This standard defines a common core of communication functionality for personal health and fitness.

**Benefit to patient**  
- Data can be easily sent to clinician  
- The ease of interoperability and integration of multi-vendor products.

**Benefit to provider**  
- Ability to monitor patient biometrics and track trends, which may result in more efficient care and a quicker recovery.



## Standard: IEEE 11073-10415

**What The Standard Does:**  
It specifies the use of specific term codes, formats, and behaviors in telehealth environments promoting interoperability. This standard defines a common core of communication functionality for personal health weighing scales.

**Benefit to patient**  
- Data can be easily sent to clinician  
- The ease of interoperability and integration of multi-vendor products.

**Benefit to provider**  
- Ability to monitor patient biometrics and track trends, which may result in more efficient care and a quicker recovery.



# Platform for Trusted Data Access via Secure Standards and Interoperability

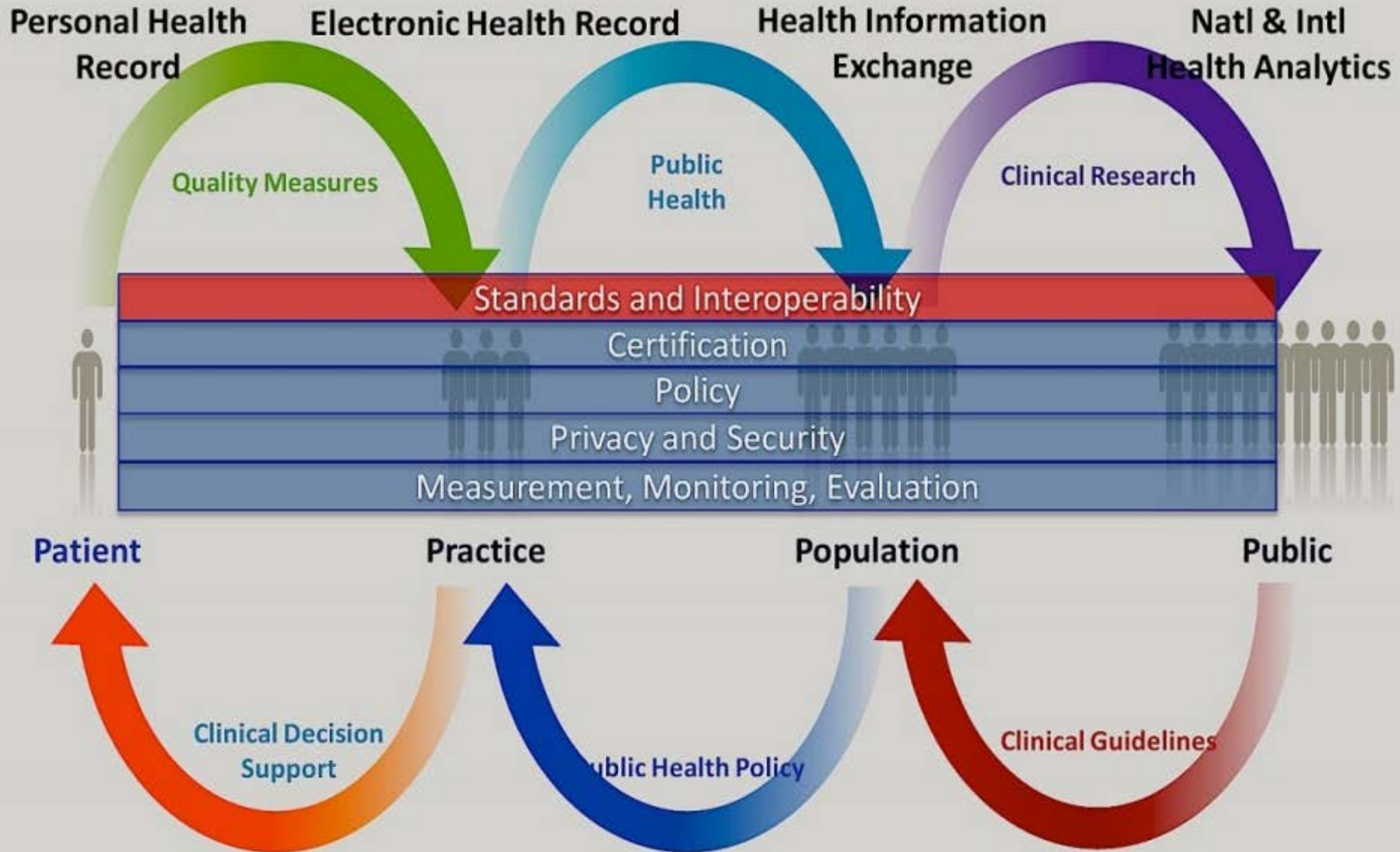

# Healthcare Data Interoperability & Standards

*... semantics, data dictionaries, billing codes*

- Terminology
  - SNOMED, LOINC
- Classification Systems
  - ICD10, CPT
- Devices
  - IEEE 11073
- EHR-Related
  - DICOM, HL7 (CDA)
- Interoperability
  - DICOM, HL7 Messaging, HIPAA Transactions, NCPDP
- Language Formats
  - XML, X12

Increase in computational time may be compensated by a relaxed priority queue which allows throughput scaling for large number of threads. Hence, parallelizing common algorithms to work on multicore chips: **The SprayList**  
[www.mit.edu/~jerryzli/SprayList-CR.pdf](http://www.mit.edu/~jerryzli/SprayList-CR.pdf)

# DIAGNOSIS CODES for SPRAINED & STRAINED ANKLES

## ICD-9

- 845.00** Sprain and strain of ankle unspecified site
- 845.01** Sprain and strain of ankle, Deltoid ligament/ Internal collateral ligament
- 845.02** Sprain and strain of ankle, Calcaneobular (ligament)
- 845.03** Sprain and strain of ankle, Tibiobular (ligament) distal

## ICD-10

- S93.401A** Sprain of unspecified ligament of right ankle – initial encounter
- S93.401D** Sprain of unspecified ligament of right ankle – subsequent encounter
- S93.401S** Sprain of unspecified ligament of right ankle – sequela
- S93.402A** Sprain of unspecified ligament of left ankle – initial encounter
- S93.402D** Sprain of unspecified ligament of left ankle – subsequent encounter
- S93.402S** Sprain of unspecified ligament of left ankle – sequela
- S93.409A** Sprain of unspecified ligament of unspecified ankle – initial encounter
- S93.409D** Sprain of unspecified ligament of unspecified ankle – subsequent encounter
- S93.409S** Sprain of unspecified ligament of unspecified ankle – sequela
- S93.412D** Sprain of calcaneobular ligament of left ankle – subsequent encounter
- S93.412S** Sprain of calcaneobular ligament of left ankle – sequela
- S93.419A** Sprain of calcaneobular ligament of unspecified ankle – initial encounter

- S93.419D** Sprain of calcaneobular ligament of unspecified ankle – subsequent encounter
- S93.419S** Sprain of calcaneobular ligament of unspecified ankle
- S93.431A** Sprain of tibiobular ligament of right ankle – initial encounter
- S93.431D** Sprain of tibiobular ligament of right ankle – subsequent encounter
- S93.431S** Sprain of tibiobular ligament of right ankle – sequela
- S93.432A** Sprain of tibiobular ligament of left ankle – initial encounter
- S93.432D** Sprain of tibiobular ligament of left ankle – subsequent encounter
- S93.432S** Sprain of tibiobular ligament of left ankle – sequela
- S93.439A** Sprain of tibiobular ligament of unspecified ankle – initial encounter
- S93.439D** Sprain of tibiobular ligament of unspecified ankle – subsequent encounter
- S93.439S** Sprain of tibiobular ligament of unspecified ankle – sequela
- S93.491A** Sprain of other ligament of right ankle (Internal collateral/ talobular) initial encounter
- S93.491D** Sprain of other ligament of right ankle (Internal collateral/ talobular) subsequent encounter
- S93.491S** Sprain of other ligament of right ankle (Internal collateral/ talobular) sequela
- S93.492A** Sprain of other ligament of left ankle, initial encounter
- S93.492D** Sprain of other ligament of left ankle subsequent encounter
- S93.492S** Sprain of other ligament of left ankle sequela
- S93.499A** Sprain of other ligament of unspecified ankle initial encounter
- S93.499D** Sprain of other ligament of unspecified ankle subsequent encounter
- S93.499S** Sprain of other ligament of unspecified ankle (Internal collateral/talobular) sequela
- S96.211A** Strain of intrinsic muscle and tendon at right ankle and foot level initial encounter
- S96.211D** Strain of intrinsic muscle and tendon at right ankle and foot level subsequent encounter
- S96.211S** Strain of intrinsic muscle and tendon at right ankle and foot level sequela
- S96.212A** Strain of intrinsic muscle and tendon at left ankle and foot level initial encounter
- S96.212D** Strain of intrinsic muscle and tendon at left ankle

- and foot level subsequent encounter
- S96.212S** Strain of intrinsic muscle and tendon at left ankle and foot level sequela
- S96.219A** Strain of intrinsic muscle and tendon at ankle and foot level, unspecified side initial encounter
- S96.219D** Strain of intrinsic muscle and tendon at ankle and foot level, unspecified side subsequent encounter
- S96.219S** Strain of intrinsic muscle and tendon at ankle and foot level, unspecified side
- S96.811A** Strain of other muscles and tendons at right ankle and foot level initial encounter
- S96.811D** Strain of other muscles and tendons at right ankle and foot level subsequent encounter
- S96.811S** Strain of other muscles and tendons at right ankle and foot level sequela
- S96.812A** Strain of other muscles and tendons at left ankle and foot level initial encounter
- S96.812D** Strain of other muscles and tendons at left ankle and foot level subsequent encounter
- S96.812S** Strain of other muscles and tendons at left ankle and foot level sequela
- S96.819A** Strain of other muscles and tendons at ankle and foot level, unspecified side initial encounter
- S96.819D** Strain of other muscles and tendons at ankle and foot level, unspecified side subsequent encounter
- S96.819S** Strain of other muscles and tendons at ankle and foot level, unspecified side sequela
- S96.911A** Strain of unspecified muscle and tendon at right ankle and foot level initial encounter
- S96.911D** Strain of unspecified muscle and tendon at right ankle and foot level subsequent encounter
- S96.911S** Strain of unspecified muscle and tendon at right ankle and foot level sequela
- S96.912A** Strain of unspecified muscle and tendon at left ankle and foot level initial encounter
- S96.912D** Strain of unspecified muscle and tendon at left ankle and foot level subsequent encounter
- S96.912S** Strain of unspecified muscle and tendon at left ankle and foot level sequela
- S96.919A** Strain of unspecified muscle and tendon at ankle and foot level, unspec. side initial encounter
- S96.919D** Strain of unspecified muscle and tendon at ankle and foot level, unspec. side subsequent encounter
- S96.919S** Strain of unspecified muscle and tendon at ankle and foot level, unspec. side sequela

# CONVERGENCE : DIAGNOSIS CODE and SEMANTIC INTEROPERABILITY ?

## ICD-9

- 845.00** Sprain and strain of ankle unspiced site
- 845.01** Sprain and strain of ankle, Deltoid ligament/ Internal collateral ligament
- 845.02** Sprain and strain of ankle, Calcaneobular (ligament)
- 845.03** Sprain and strain of ankle, Tibiobular (ligament) distal

## ICD-10

- S93.401A** Sprain of unspiced ligament of right ankle – initial encounter
- S93.401D** Sprain of unspiced ligament of right ankle – subsequent encounter
- S93.401S** Sprain of unspiced ligament of right ankle – sequela
- S93.402A** Sprain of unspiced ligament of left ankle – initial encounter
- S93.402D** Sprain of unspiced ligament of left ankle – subsequent encounter
- S93.402S** Sprain of unspiced ligament of left ankle – sequela
- S93.409A** Sprain of unspiced ligament of unspiced ankle – initial encounter
- S93.409D** Sprain of unspiced ligament of unspiced ankle - subsequent encounter
- S93.409S** Sprain of unspiced ligament of unspiced ankle – sequela
- S93.412D** Sprain of calcaneobular ligament of left ankle – subsequent encounter
- S93.412S** Sprain of calcaneobular ligament of left ankle – sequela
- S93.419A** Sprain of calcaneobular ligament of unspiced ankle – initial encounter

Proprietary closed semantic data dictionaries (EPIC) and heterogeneity of billing codes are contributors to lack of semantic interoperability and inhibitor for OS platforms



# Barriers to Interoperability? Role of Ontology and Semantics in the Healthcare Standards Landscape

## INTERNATIONAL HEALTHCARE STANDARDS LANDSCAPE

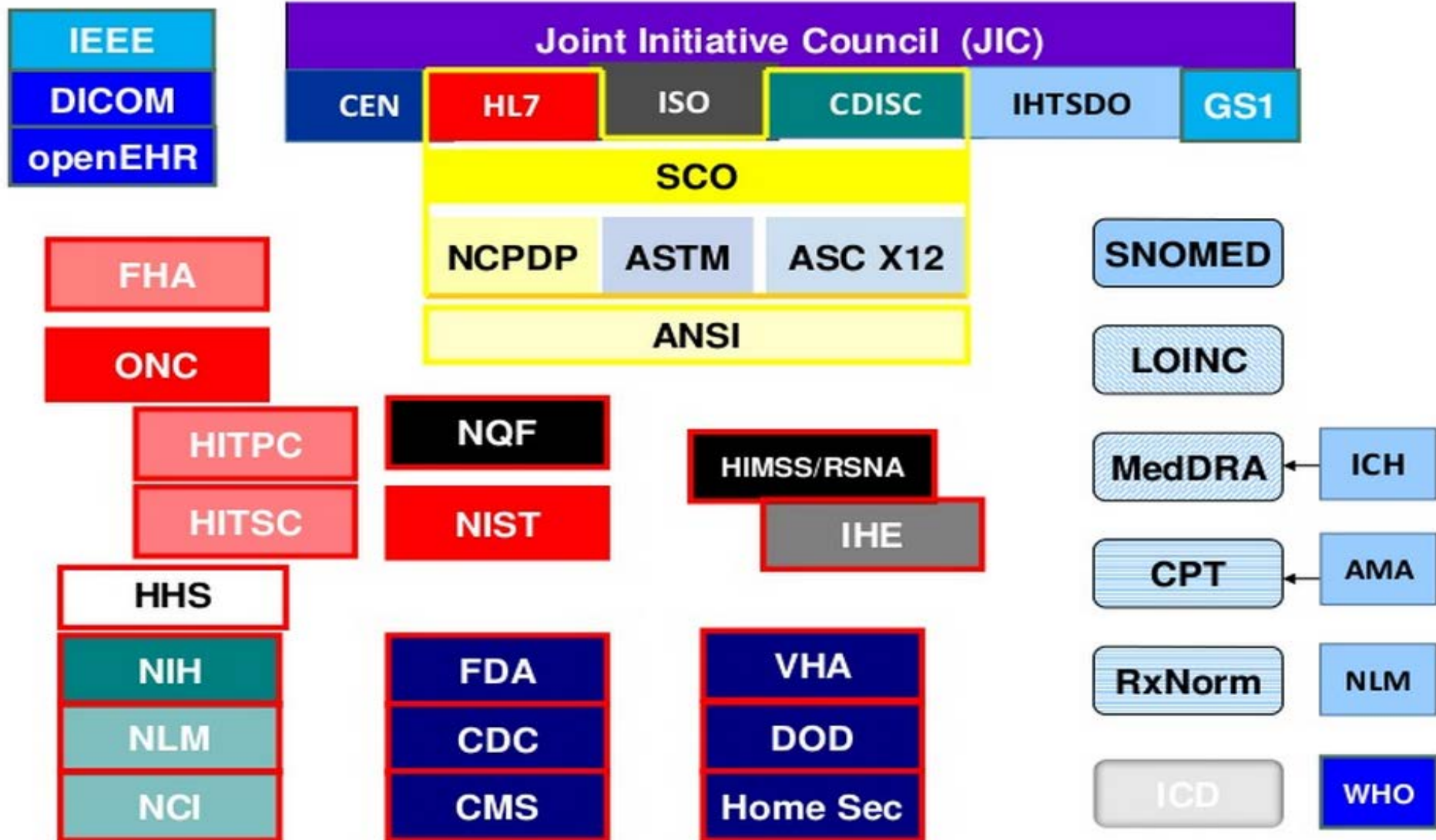

# Digital Health Frameworks

Must address security, data integration, diagnostic platforms and tools with health IT interoperability

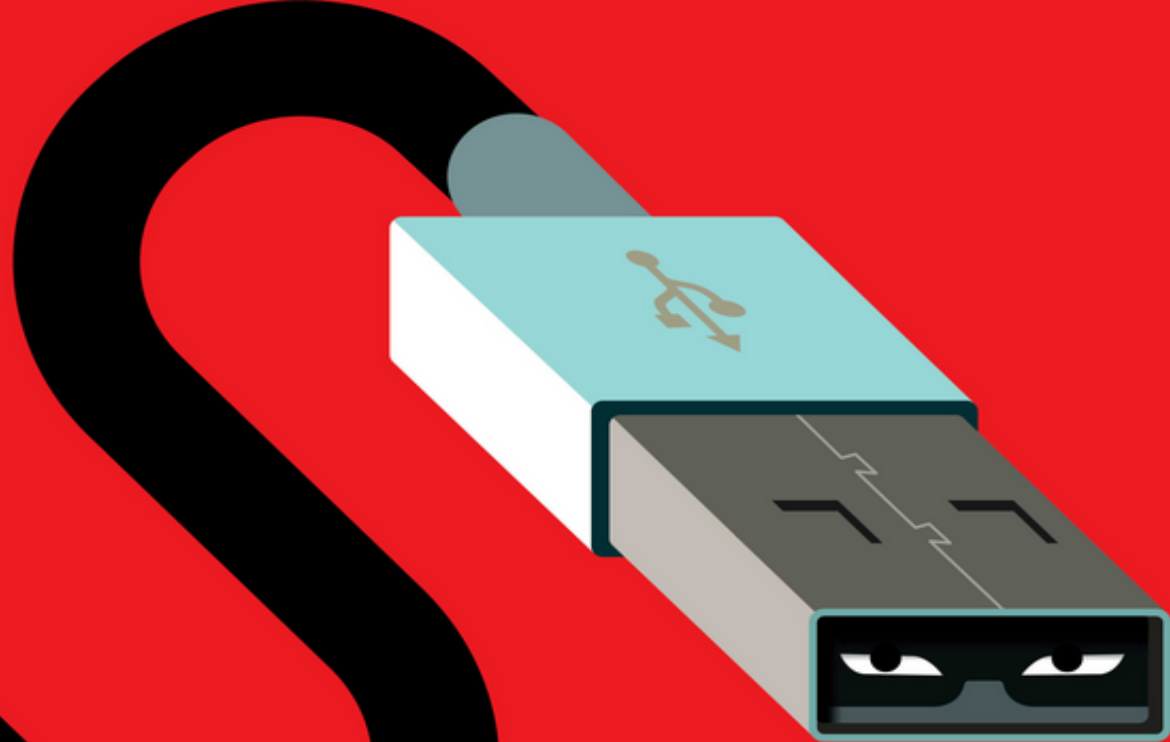

The Agenda  
INTERNET OF THINGS

# I helped invent the Internet of Things. Here's why I'm worried about how secure it is.

By SANJAY SARMA

Peter Greenwood for POLITICO

- I'm a mechanical engineering professor at MIT, and 17 years ago, with my colleagues David Brock, Kevin Ashton and Sunny Siu, I helped launch the research effort that laid some of the groundwork for the Internet of Things. As you might imagine, my life is pretty connected.

# Remote Robotic Surgery – Operation Theatre of the Future



# Operational Security of the Future ?

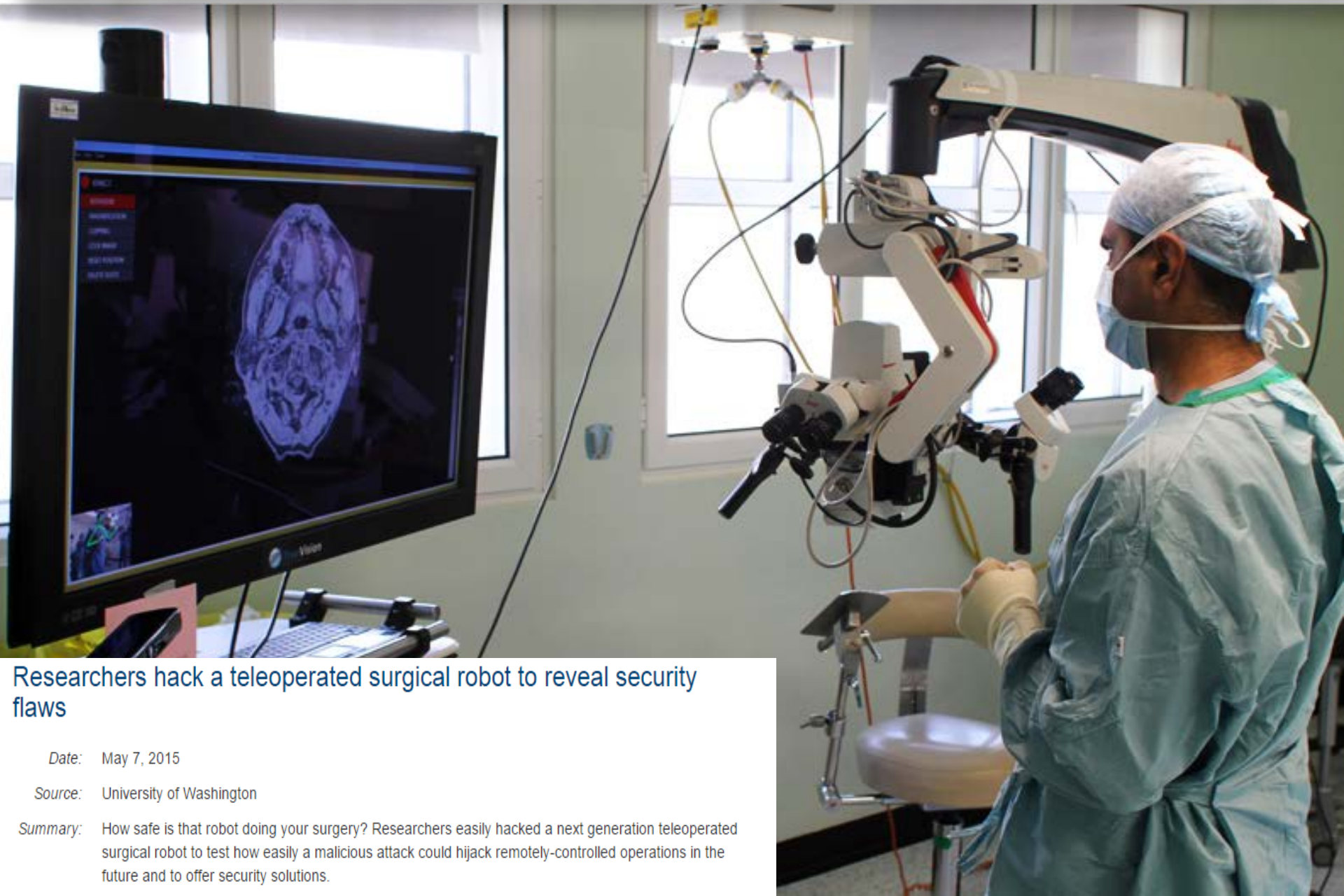

## Researchers hack a teleoperated surgical robot to reveal security flaws

*Date:* May 7, 2015

*Source:* University of Washington

*Summary:* How safe is that robot doing your surgery? Researchers easily hacked a next generation teleoperated surgical robot to test how easily a malicious attack could hijack remotely-controlled operations in the future and to offer security solutions.



NSF CPS  
MEDICAL  
DEVICE  
SECURITY

IIC MEMBERS  
UPENN  
INTEL

Press Release 15-096

## A partnership to secure and protect the emerging Internet of Things

National Science Foundation and Intel Corporation team to improve the security and privacy of computing systems that interact with the physical world using a new cooperative research model



Researchers will adapt smart alarm research to detect and react to attacks on medical devices. 28 August 2015

# Apply Analytical Rigor of CPS to Health IT

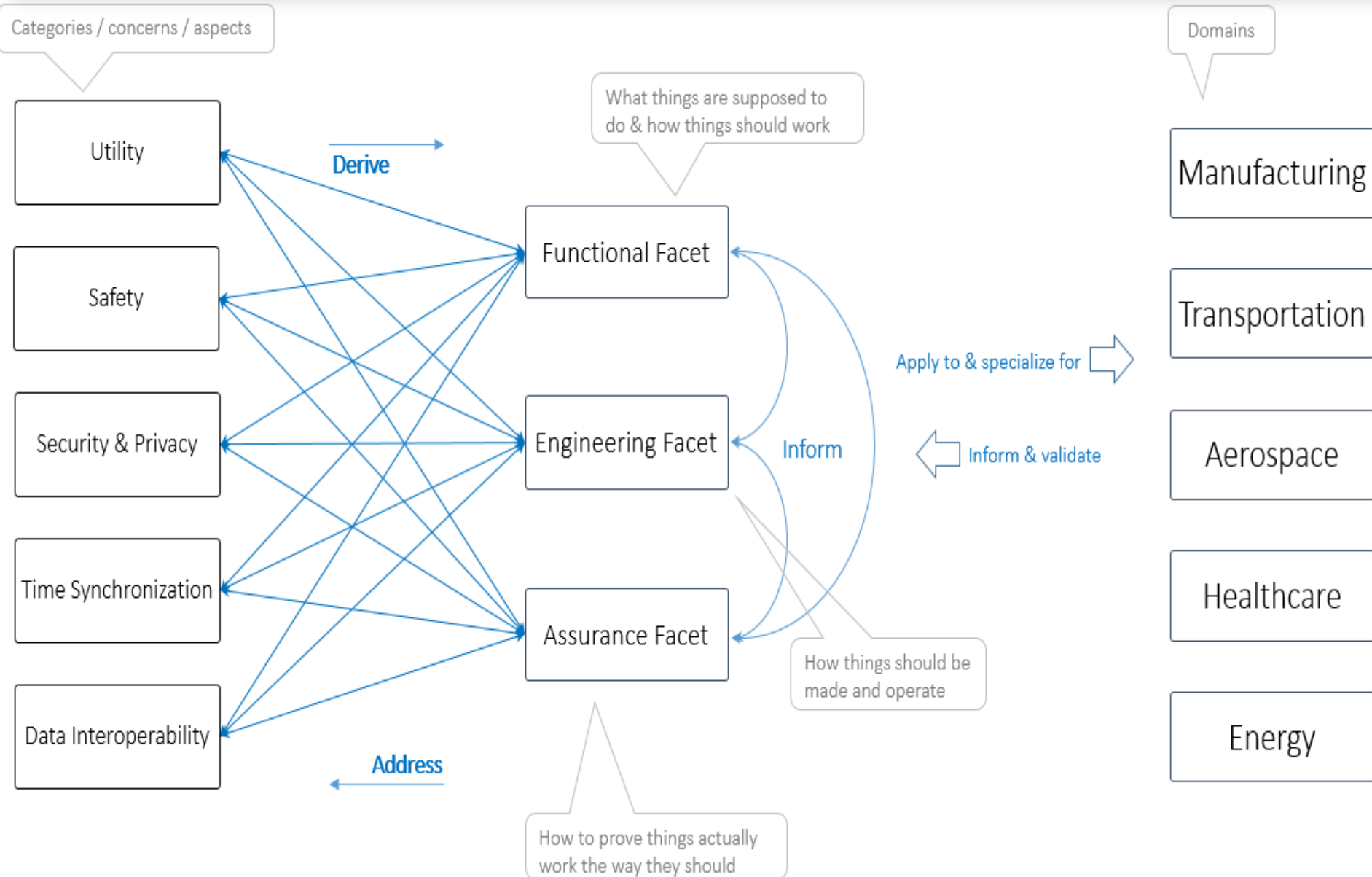

# General Abstraction • Connectivity, Open Platforms and Broad Spectrum of Applications

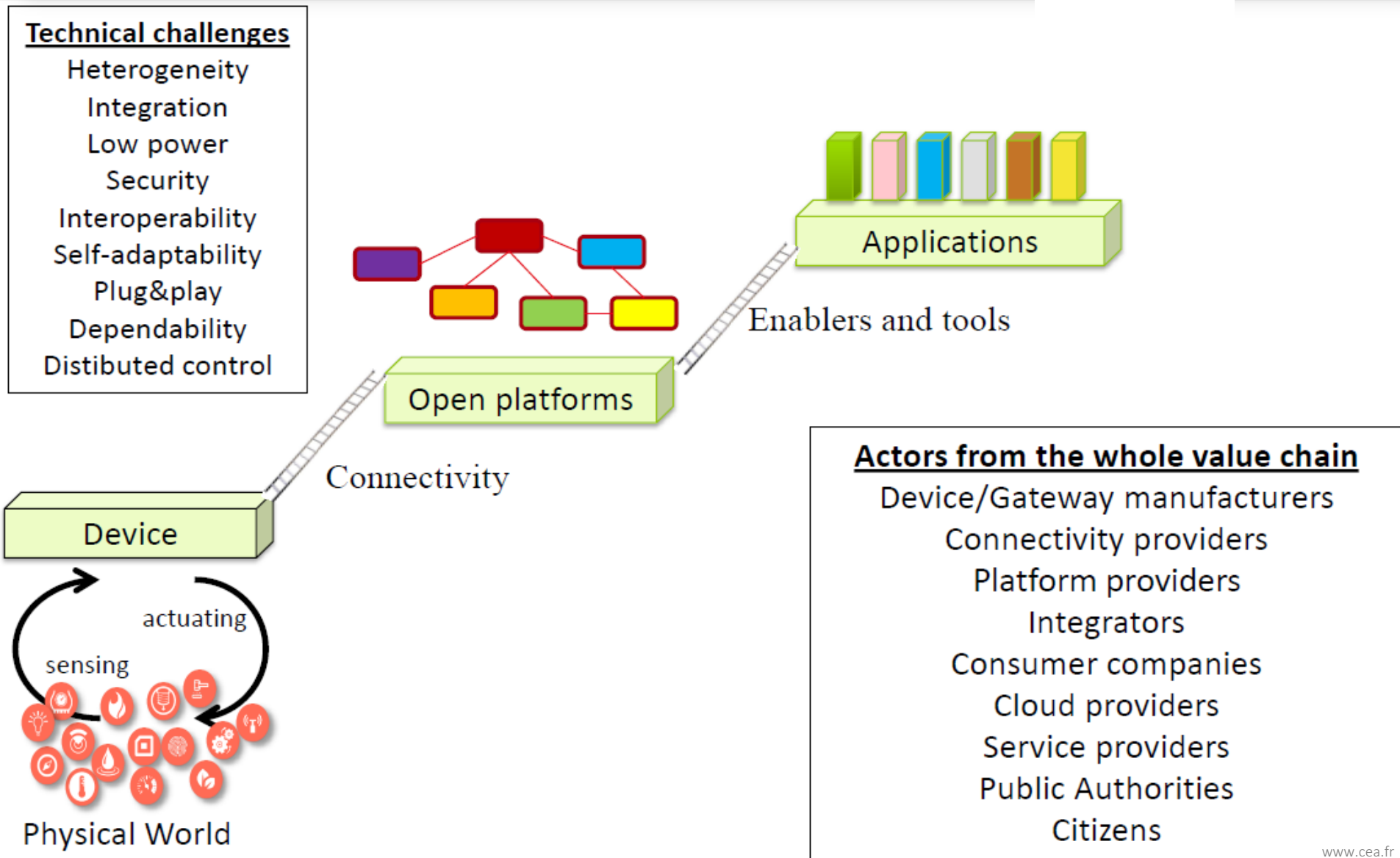



# AVM Component Model

Can it help medical device interoperability & integrated clinical environment ?

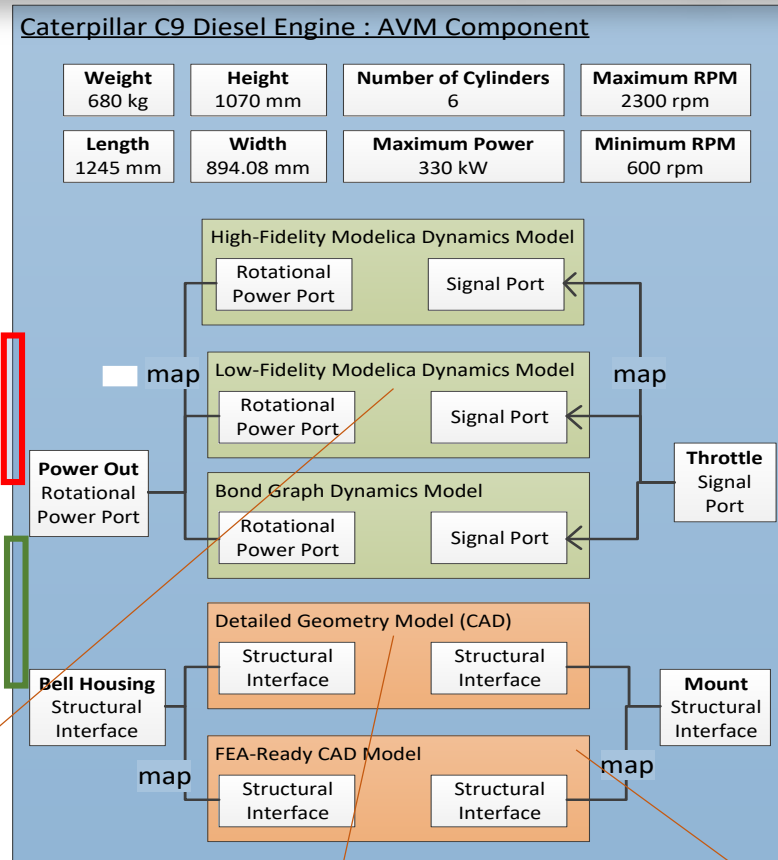

Parameter/property interfaces

Power interfaces

Signal interfaces

Structural interfaces

Structural interfaces

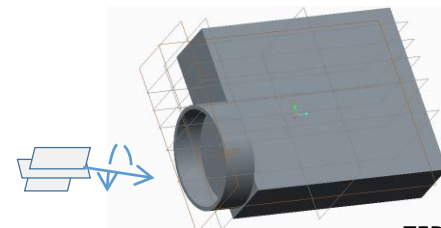
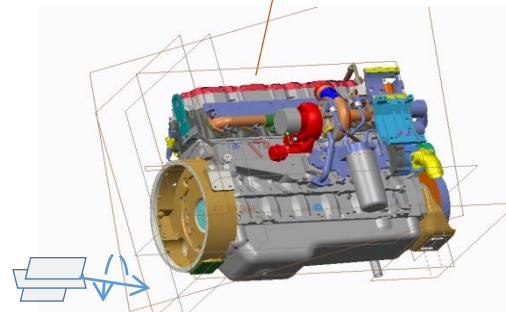
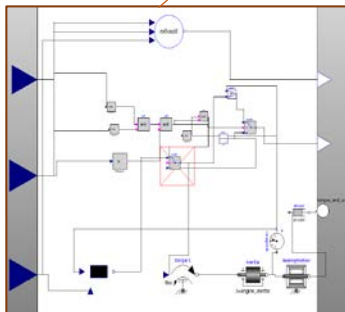

# Meta Tool Suite Architecture

Can it help medical device interoperability & integrated clinical environment?

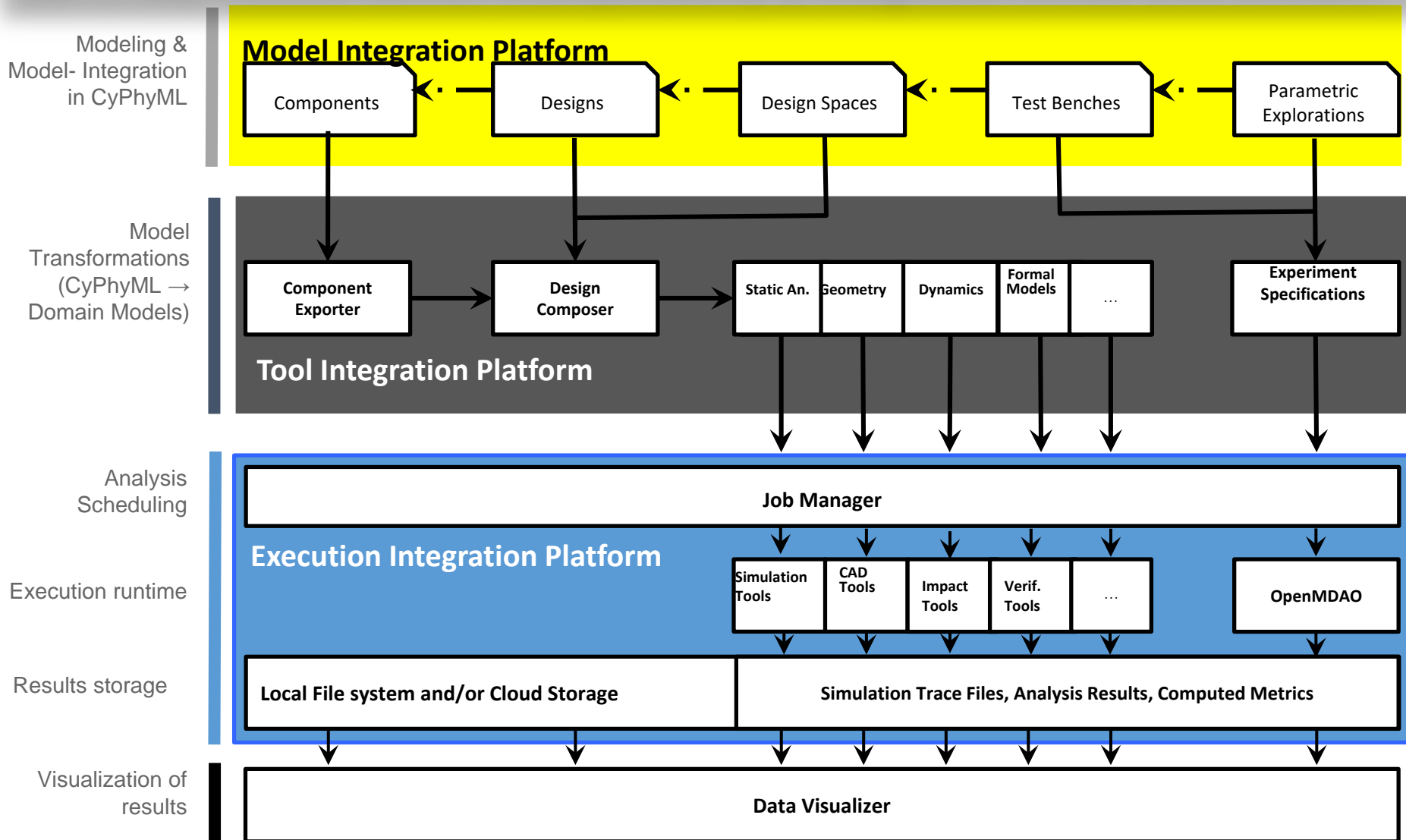

# AVM Component Model

Can it help medical device interoperability and integrated clinical environment ?

If you combine the model and the tool suite can you create an exact digital representation of the dynamic clinical environment of the patient attached to various devices from ER to OR and from post-operative ICU to discharge?

The creation of a digital duplicate as an entity level agent based model is essential to analytics and simulation of what-if scenarios (deterministic) to better prepare for the non-deterministic states (emergency). This approach is not limited to medicine but crucial for any “atom” with connected bits (data),

Digital duplication will be the underpinning of all most all elements in the context of connectivity (IoT, IIoT). Data from each individual node of this model (eg sensor data from each part in a machine with hundreds of parts) will feed the digital duplicate connected to algorithm engines in the cloud to drive real-time analytics, provide feedback to improve efficiency or precision of the machine or device or process or decision support system in a manner that is context-aware and delivers intelligence at the edge to boost autonomy.

## Meta Tool Suite Architecture

Can it help medical device interoperability and integrated clinical environment?

# Evolution of the Integrated Healthcare Platform(s) n-Directional Data Access via Secure Interoperable Standards

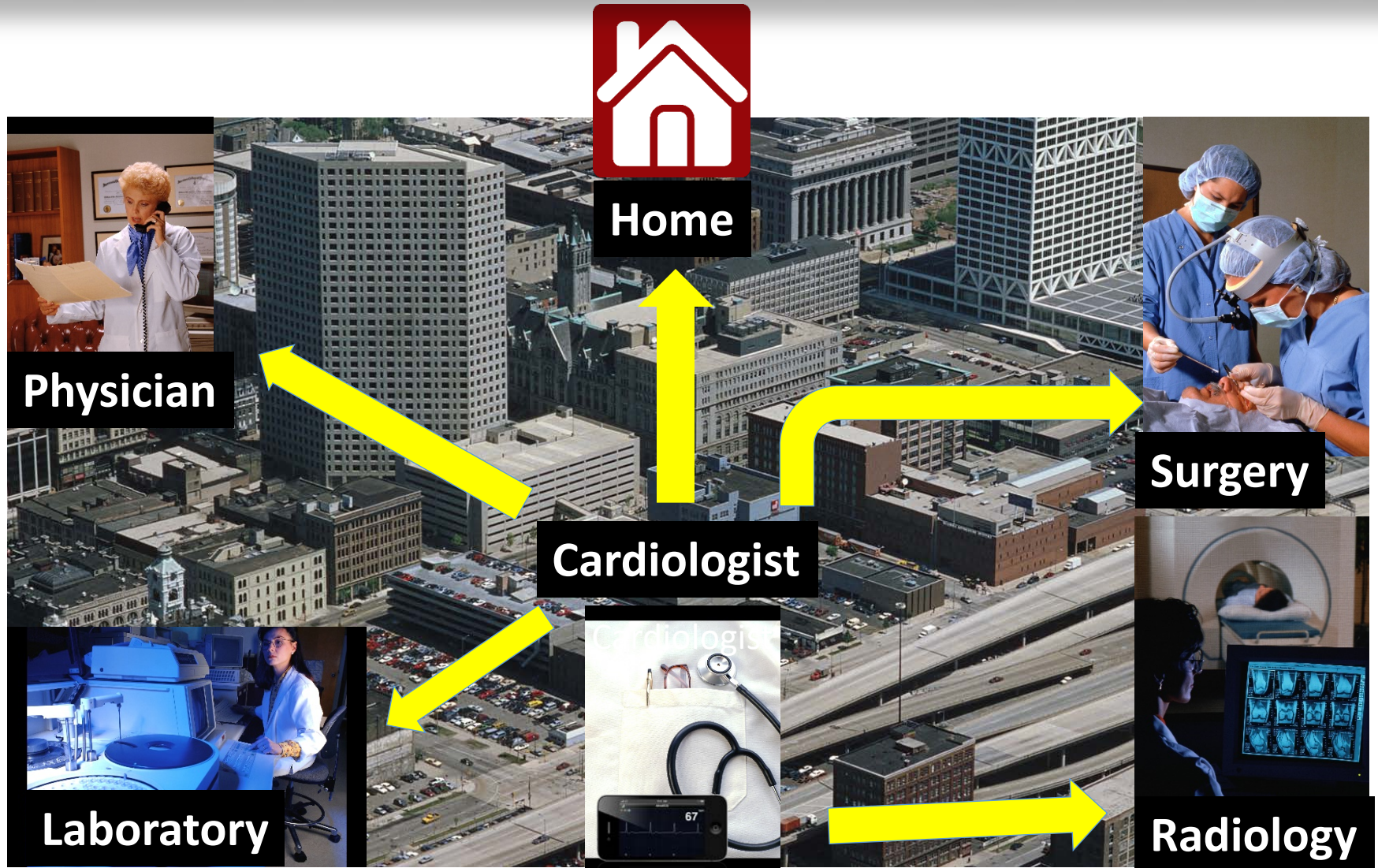

# Ubiquitous Remote Monitoring from Edge Devices

## Potential Diagnostic Value in Digital Health IT



General Purpose In and Out – GPIO  
CPU, Memory (16 GB), WiFi, Bluetooth

Edge Ambient Intelligence – Analytics in the Mist  
Latency boundary unsuitable for fog or the cloud

# Ubiquitous Remote Monitoring from Edge Devices

## EYERISS – real time analytics for Digital Health PoC



[http://www.rle.mit.edu/eems/wp-content/uploads/2016/02/eyeriss\\_isscc\\_2016\\_slides.pdf](http://www.rle.mit.edu/eems/wp-content/uploads/2016/02/eyeriss_isscc_2016_slides.pdf)

[http://people.csail.mit.edu/emert/papers/2016.06.isca.eyeriss\\_architecture.pdf](http://people.csail.mit.edu/emert/papers/2016.06.isca.eyeriss_architecture.pdf)

<https://dspace.mit.edu/handle/1721.1/101151>

MIT introduced a new computer chip optimized for deep-learning, an approach to AI. The chip, dubbed "Eyeriss" could allow mobile devices to perform tasks like natural language processing and facial recognition without being connected to the internet. It's the latest attempt to make the complex operations of machine learning more portable. That means that our smartphones, wearables, robots, self-driving cars, and other IoT devices could begin performing complex deep learning processes, locally, with the aid of analytical engines at the edge (without cloud or fog).

# How will sensor-enabled wearables integrate with the ecosystem of digital health IT ?



# BAN – Body Area Networks

- Bluetooth-enabled sensors / devices
- AMMO receives/uploads sensor data

- glucose
- heart rate
- pulse oximeter
- body temperature
- pedometer

Sensor

TA HH

AMMO

- Soldier in desert (high temperature)
- Monitor health via sensor data / analytics
- Intervene before it is necessary / prevent A&E

Sensor

Sensor

## POTENTIAL AMMO APPLICATIONS

- o Pre- and Post- surgery interactive care plan execution and monitoring
- o Improved home-health & patient communication with social partners
- o Remediate loss of HIV patients identified for anti-retro viral treatment
- o Ebola Infection - patient, population and physician data / monitoring
- o Adhoc mesh / zero configuration networking for search & rescue (A&E)
- o Google Project Ara - integrated/on-platform tactical radio and SDR
- o Novel nano-sensors with embedded sub-cutaneous radio/transmitters

[Sandeep Neema](#)

# Android Mobile Middleware Objects



# Emergence of IoS Preventive Medicine Era • Wearable Diagnostic Devices with High Performance Ultra-Sensitive Nano-Sensors

*Swiss engineer George de Mestro invented Velcro after his dog came home covered with thistle burrs, Speedo learned from sharkskin to make faster swimsuits, and chemical companies designed self-cleaning paint after studying lotus leaves.*

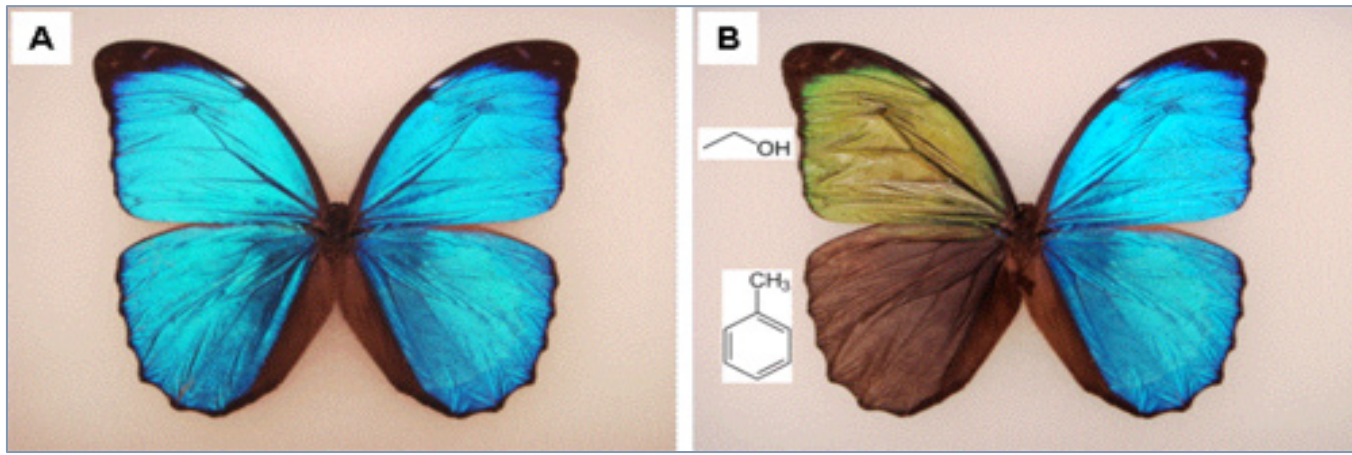

GE scientists have observed that *Morpho* wings change their color when they come into contact with heat, gases and chemicals. The normal iridescent blue color of butterfly wings (A) changes when exposed to ethanol (panel B top) or toluene (panel B bottom). Radislav Potyrailo's team at GE wants to use their findings to develop fast, ultra-sensitive thermal and chemical imaging sensors for applications in night vision goggles, super-sensitive surveillance cameras, handheld or wearable medical diagnostic devices.  [www.gereports.com/post/80985289914/like-a-butterfly-out-of-hell-the-next-wave-of](http://www.gereports.com/post/80985289914/like-a-butterfly-out-of-hell-the-next-wave-of)

# Digital Health Diagnostics

*MloT as a catalyst for preventative medicine?*

DO ANY OF YOUR  
RELATIVES SUFFER  
FROM MENTAL ILLNESS?

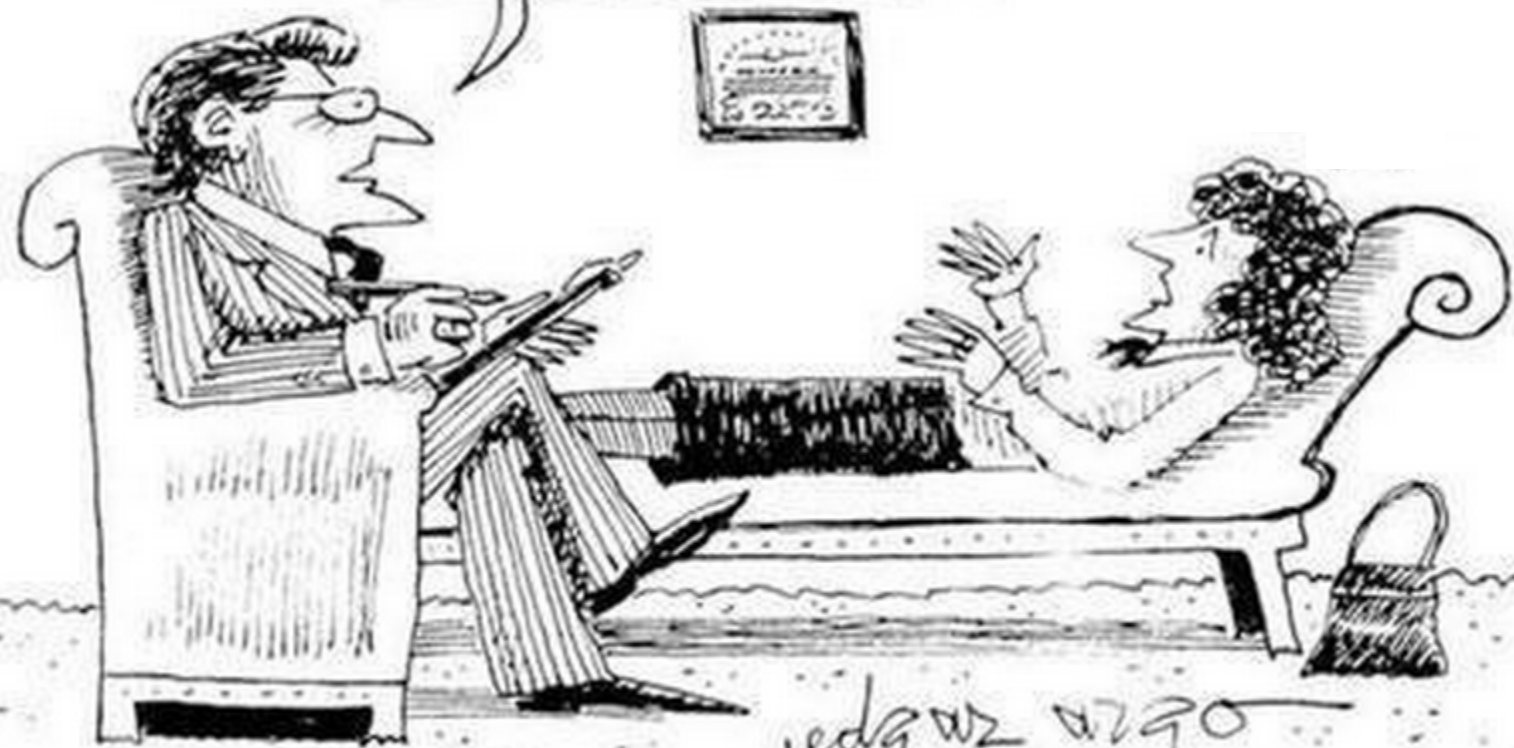

edg w2 0290

DO ANY OF YOUR  
RELATIVES SUFFER  
FROM MENTAL ILLNESS?

NO... THEY  
ALL SEEM  
TO ENJOY  
IT!!!



edg w2 0290



## Michael S. Strano

Carbon P. Dubbs Professor of Chemical Engineering  
Department of Chemical Engineering  
Massachusetts Institute of Technology  
Room 66-570B  
77 Massachusetts Ave  
Cambridge MA 02139 USA

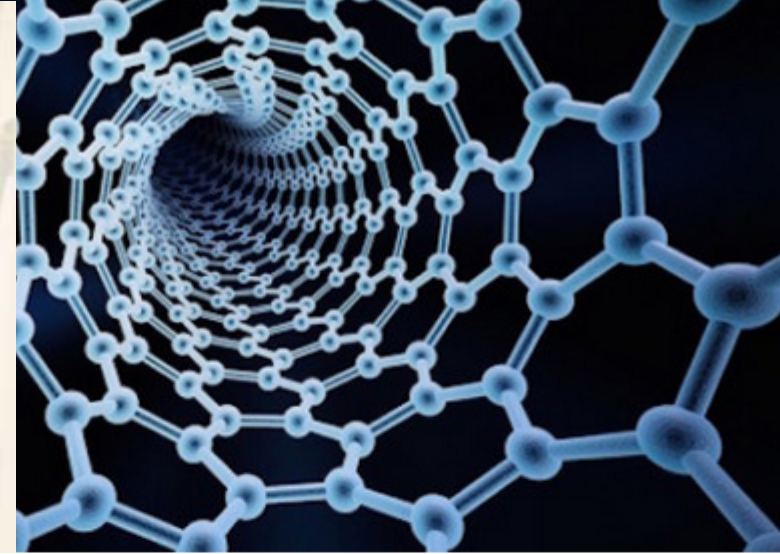

Embedded nano-sensors and nano-radios will transmit data from inside the body using ad hoc mesh networks (nano-com). They may coordinate actions of nano-bots and nano-drones introduced through nasal inhalation or epidermal patches to optimize time-dependent drug delivery, radio/laser ablation, magnetic monitoring or surgically remove abnormal growth. Real-time internal data will help manage external support, such as printed stem cell therapy or assembly of pre-synthetic peptides to form active proteins (think printed insulin in your medicine cabinet).

### NANOTUBES

## IMPLANTED NANOTUBE SENSOR DIAGNOSTICS

© AUGUST 24, 2015

MIT researchers are developing tiny devices made from polymer wrapped carbon nanotubes that detect insulin, nitric oxide and fibrinogen — simplifying and automating diagnostic tests.

Past efforts to develop implantable sensors have failed, due to the body's inclination to protect itself and recycle biological material. Devices can become wrapped in scar tissue, or their components can be broken down. The team believes that the nanotube sensors can be effective for the long term.

# Printed Proteins?

*Printed Insulin? What about secondary structure?*

# Printed Proteins? It could happen ...

Figure 1: Snapshot of a peptoid nanosheet obtained from molecular-dynamics simulations.

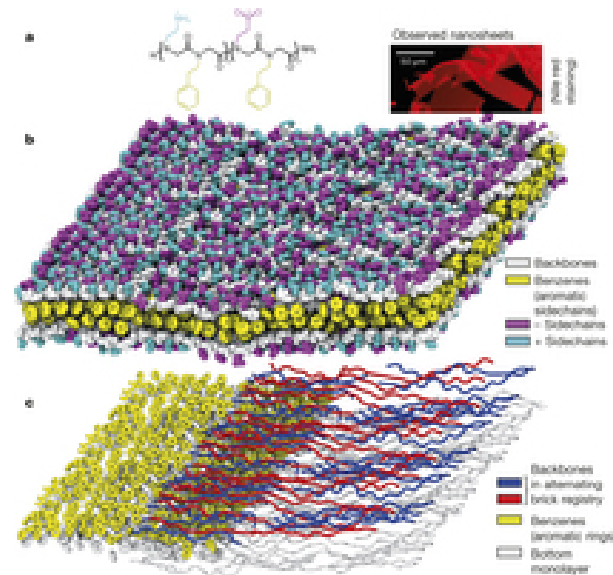

a, Left, an amphiphilic 28-residue peptoid, which assembles into extended nanosheets only two molecules thick<sup>10</sup>, as shown in the fluorescent-microscopy image to the right. b, Snapshot of a bilayer, obtained from molecular-dynamics simul...

# Peptoid nanosheets exhibit a new secondary-structure motif

Ranjan V. Mannige, Thomas K. Haxton, Caroline Proulx, Ellen J. Robertson, Alessia Battigelli, Glenn L. Butterfoss, Ronald N. Zuckermann & Stephen Whitelam

[Affiliations](#) | [Contributions](#) | [Corresponding authors](#)

*Nature* (2015) | doi:10.1038/nature15363

Received 20 April 2015 | Accepted 27 July 2015 | Published online 07 October 2015

A promising route to the synthesis of protein-mimetic materials that are capable of complex functions, such as molecular recognition and catalysis, is provided by sequence-defined peptoid polymers<sup>1, 2</sup>—structural relatives of biologically occurring polypeptides. Peptoids, which are relatively non-toxic and resistant to degradation<sup>3</sup>, can fold into defined structures through a combination of sequence-dependent interactions<sup>3, 4, 5, 6, 7, 8</sup>. However, the range of possible structures that are accessible to peptoids and other biological mimetics is unknown, and our ability to design protein-like architectures from these polymer classes is limited<sup>9</sup>. Here we use molecular-dynamics simulations, together with scattering and microscopy data, to determine the atomic-resolution structure of the recently discovered peptoid nanosheet, an ordered supramolecular assembly that extends macroscopically in only two dimensions. Our simulations show that nanosheets are structurally and dynamically heterogeneous, can be formed only from peptoids of certain lengths, and are potentially porous to water and ions. Moreover, their formation is enabled by the peptoids' adoption of a secondary structure that is not seen in the natural world. This structure, a zigzag pattern that we call a  $\Sigma$  ('sigma')-strand, results from the ability of adjacent backbone monomers to adopt opposed rotational states, thereby allowing the backbone to remain linear and untwisted. Linear backbones tiled in a brick-like way form an extended two-dimensional nanostructure, the  $\Sigma$ -sheet. The binary rotational-state motif of the  $\Sigma$ -strand is not seen in regular protein structures, which are usually built from one type of rotational state. We also show that the concept of building regular structures from multiple rotational states can be generalized beyond the peptoid nanosheet system.



# Conceptual Convergence of Material Genome with the Human Genome?

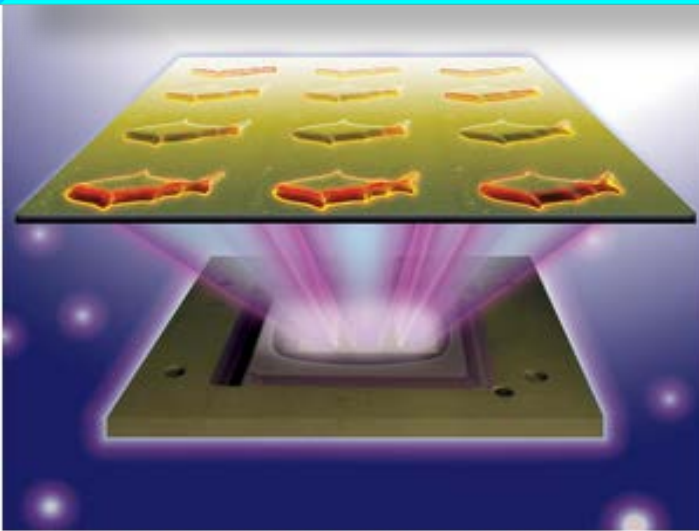

“With our 3D printing technology, we are not limited to just fish shapes. We can rapidly build micro-robots inspired by other biological organisms such as birds,” said Zhu.

Prof Shaochen Chen and Joseph Wang, NanoEngineering Dept, UC San Diego

3D-printed microfish contain functional nanoparticles that enable them to be self-propelled, chemically powered and magnetically steered. The microfish are also capable of removing and sensing toxins. Image

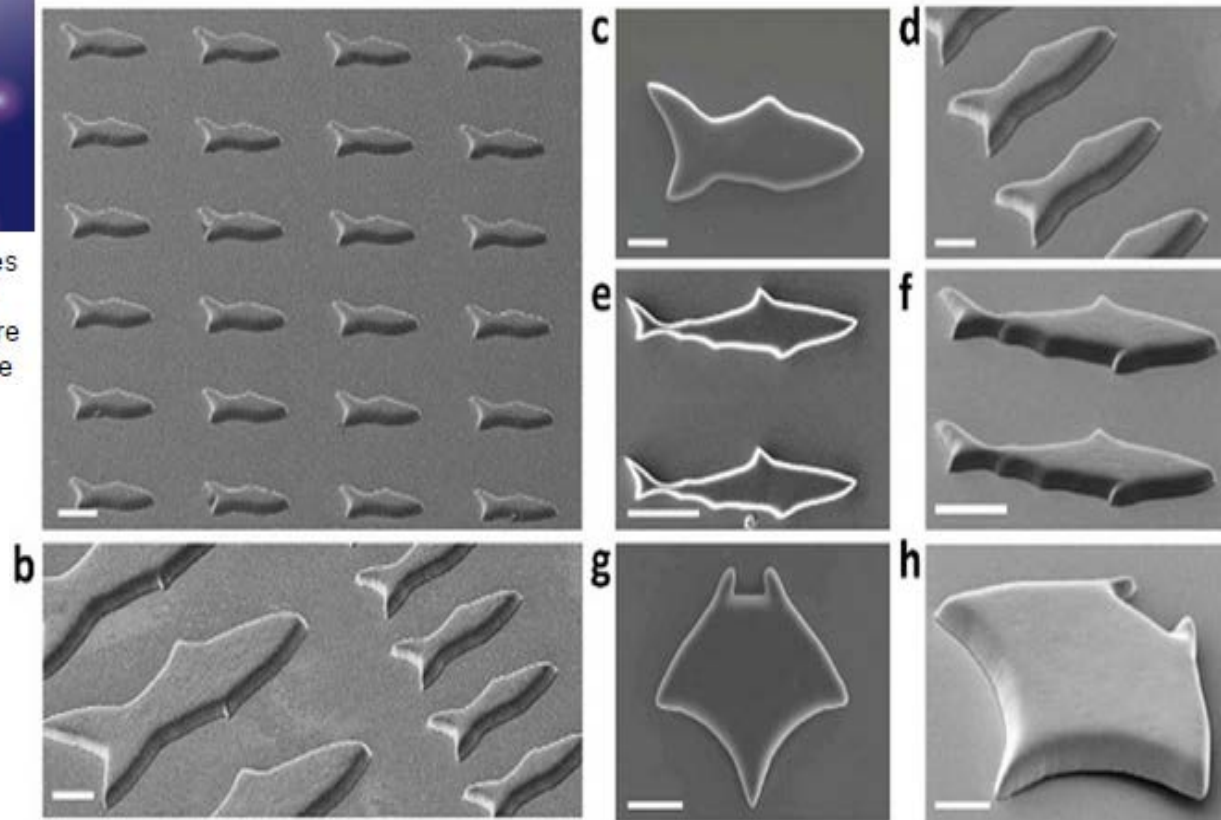

3D printed robots from iron oxide, which can be magnetically guided; platinum, which can be chemically guided; and polydiacetylene (PDA) which can be used for neutralising harmful toxins.

## 3D-Printed Artificial Microfish

*Wei Zhu, Jinxing Li, Yew J. Leong, Isaac Rozen, Xin Qu, Renfeng Dong, Zhiguang Wu, Wei Gao, Peter H. Chung, Joseph Wang,\* and Shaochen Chen\**

To maneuver within their environment, aquatic organisms employ a variety of locomotive strategies. These diverse mechanisms offer inspiration in designing artificial microswimmers for applications ranging from directed drug delivery to accelerated environmental decontamination.<sup>[1–6]</sup> One challenge in adapting naturally evolved designs for “smart” microswimmer systems lies in replicating their complex biomimetic form and function. Here, using a rapid 3D printing platform – microscale continuous optical printing ( $\mu$ COP) – we engineered hydrogel microfish featuring biomimetic structures, locomotive capabilities, and functionalized nanoparticles. The  $\mu$ COP system can print complex 3D structures within seconds at high resolution ( $\approx 1 \mu\text{m}$ ) across multiple orders of magnitude in scale. The 3D-printed microfish exhibits propulsion that is highly efficient, chemically powered, and magnetically guidable. By incorporating polydiacetylene (PDA) nanoparticles, we demonstrate the microfish’s utility in toxin-neutralization applications. The multiple capabilities integrated within these proof-of-concept microfish highlight the technical flexibility and broad applicability of our approach in engineering advanced functional biorobotics for actuation, sensing, and detoxification.

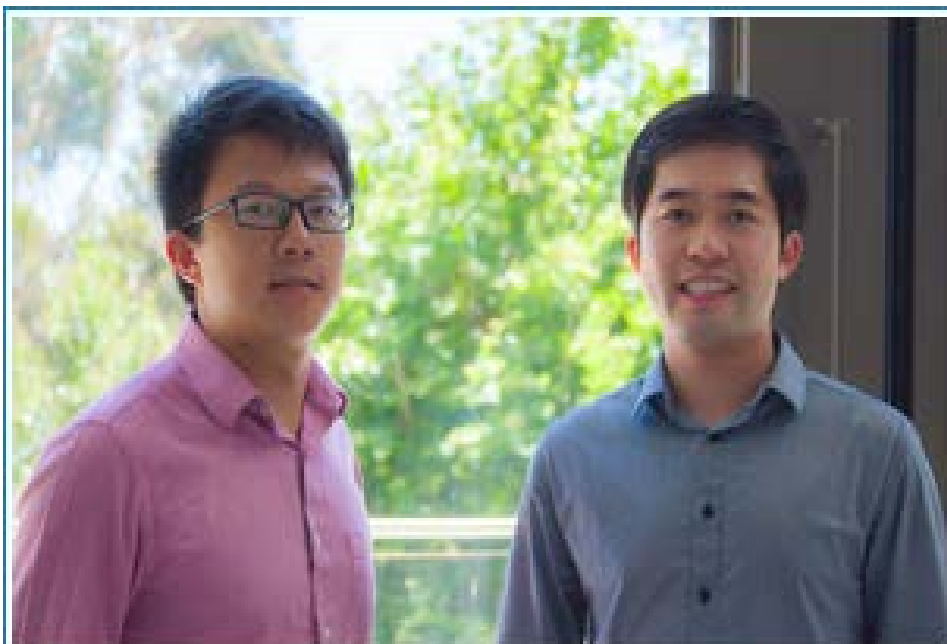

The co-first authors Jinxing Li (right) and Wei Zhu (left), both nanoengineering Ph.D. students at the UC San Diego Jacobs School of Engineering.

# Target Specific Analytes in Detection, Monitoring & Treatment

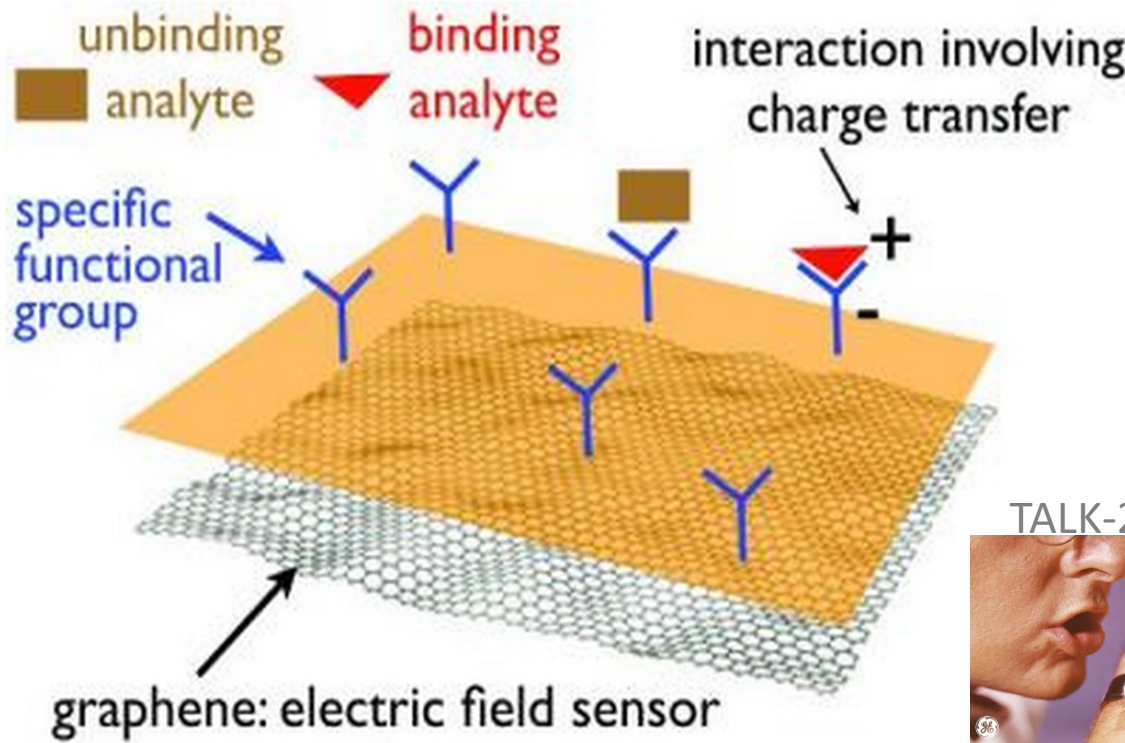
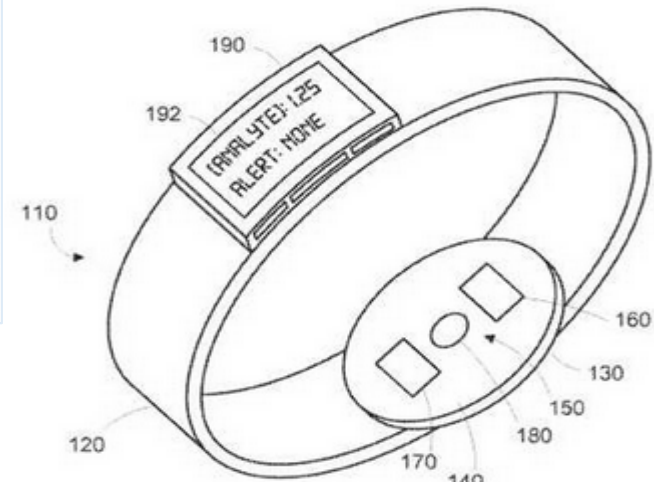
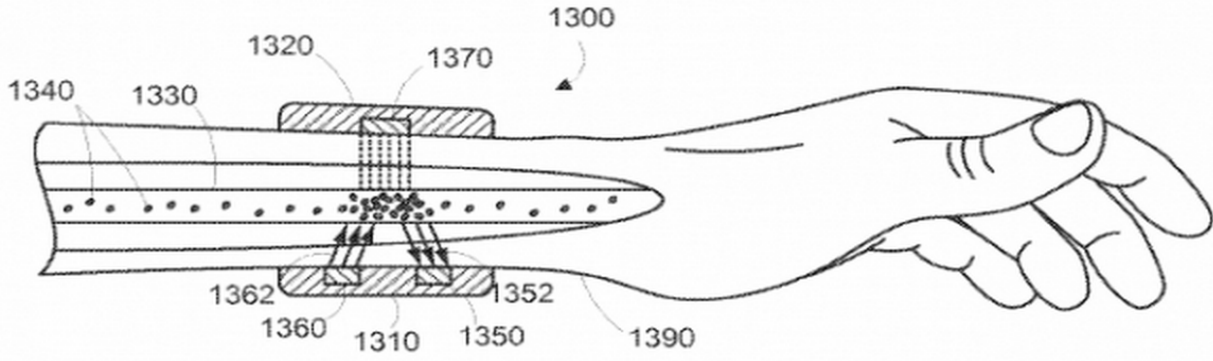

# New test can predict cancer up to 13 years before disease develops

<http://genesdev.cshlp.org/content/19/18/2100.full.pdf+html>

People who develop cancer have shorter telomeres, the caps at the end of chromosomes which protect the DNA

Target Specific Analytes in Detection, Monitoring & Treatment



ANALYTES ??  
Cohesin ?  
Shelterin ?  
Condensin ?

<http://bit.ly/SHELTERIN-ANALYTE-FOR-TELOMERE>

# Pay-Per-Pee Home Health IoT Wireless Toilet Bowl Connected to Health IT



Weigh-scale, BMI, FOBT, urine analysis, sugar, ketone body analysis, blood pressure monitor, pulse oximeter, networked to phone via WiFi and/or Bluetooth with biometrics and face recognition for secure communication with physician and hospital or clinic, globally.



Value Network Ecosystem Testbed

- Walgreens – Retail Healthcare
- GE – Equipment
- Cisco – IPv6 Routers
- AT&T – Data Transmission
- Intel – MIPS
- IBM – Data Analytics
- Samsung – Diagnostic Apps
- Walmart – Grocery Supply Chain



PDEXA SCAN  
BONE MINERAL  
DENSITY PROFILE



PDEXA SCAN  
BONE MINERAL  
DENSITY PROFILE



PDEXA SCAN  
in every drug  
store, petrol  
pump, grocery

### Osteoporosis

EU → 28 million in 2010 to 34 million in 2025 (increase of 23%)

US → 44 million (represents 55% of people aged 50+)

Brazil → 10 million (1 in every 17)

India → 36 million (2013)

China → 70 million (50+). Cost of treatment USD1.5 billion in 2006.  
Estimated US\$12.5 billion in 2020 and US\$265 billion in 2050.

In 2008, Indonesia had 34 DXA machines, half of them in Jakarta (population 237 million) which translates to 0.001 machine per 10,000 population. The equivalent recommended number for Europe is 0.11 (per 10,000)



<http://bit.ly/BONE-HEALTH>

Health data



**CONNECT**



GROCERY STORE  
PURCHASE LOG



Integrated system detects fall in bone density and correlates with reduced purchase of milk. Prevention for osteoporosis starts early. Avoids trauma and/or morbidity from broken bones. Connected healthcare data.

# US Healthcare spending nears \$4 trillion (2013)

Spending category	Costs estimated in NHEA categories (in billions)		Costs estimated with sources other than NHEA (in billions)	
	Direct Costs		Direct Costs	Indirect/ Imputed costs
Hospital care	Hospital care	\$814		
Professional services	Physician and clinical services	\$516		
	Dental services	\$105		
	Other professional services	\$68		
	Other personal health care	\$129		
			All other ambulatory	\$19
			CAM practitioner costs	\$31
			Weight-reducing centers	\$2
Long-term care (LTC)	Home health care	\$70		
	Nursing home care	\$143		
		Homes for the elderly	\$17	
Prescription drugs	Prescription drugs	\$259		
Retail products and services	Durable medical equipment	\$38		
	Other non-durable medical products	\$45		
			CAM products	\$2
			Health publications	\$2
			Nutrition/supplements	\$56
Direct administrative costs	Total non-personal health care	\$408		
Supervisory care			Supervisory care	\$492
<b>Total</b>		<b>\$2,594</b>	<b>\$129</b>	<b>\$492</b>



### **Cancer Treatment**

**\$2,900** HCG Oncology, India

**\$22,000** U.S. average

### **Kidney Dialysis**

**\$12,000** Deccan Hospital, India

**\$66,750** U.S. average

# Fast Forward → Penny Per Person Per Use Per Day

\$1 - Bone density

\$1 - Mammogram

at the corner of Happy and Healthy in every zip code in India, China, Indonesia

data transmitted to specialists and reports sent to individuals, doctor and clinic

An old idea (2004)  
*gets some new wings*

# Glucose NanoSensor

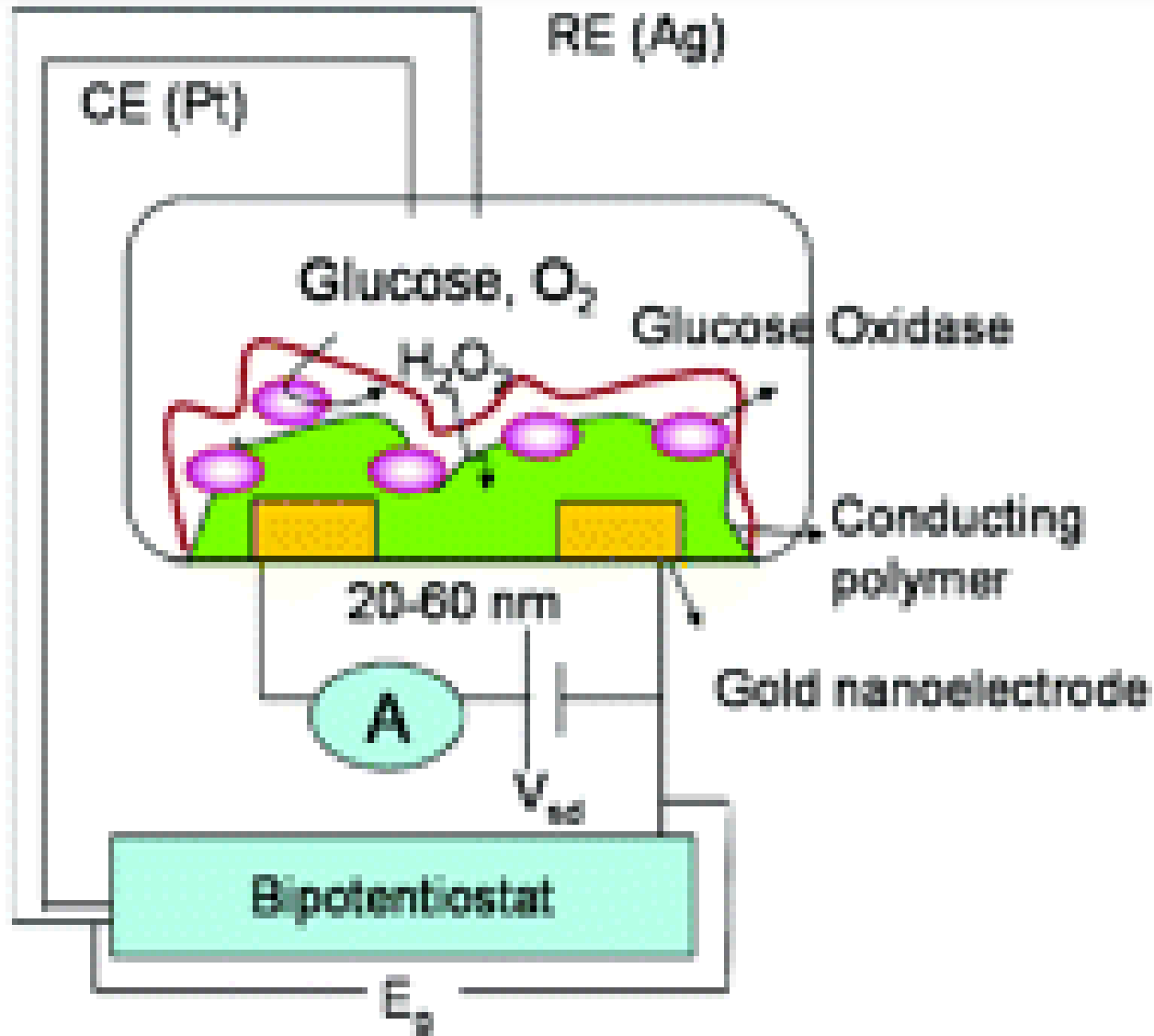

The Industrial Internet  
 The Industrial Internet of Things  
 The Industrial Internet of Healthcare

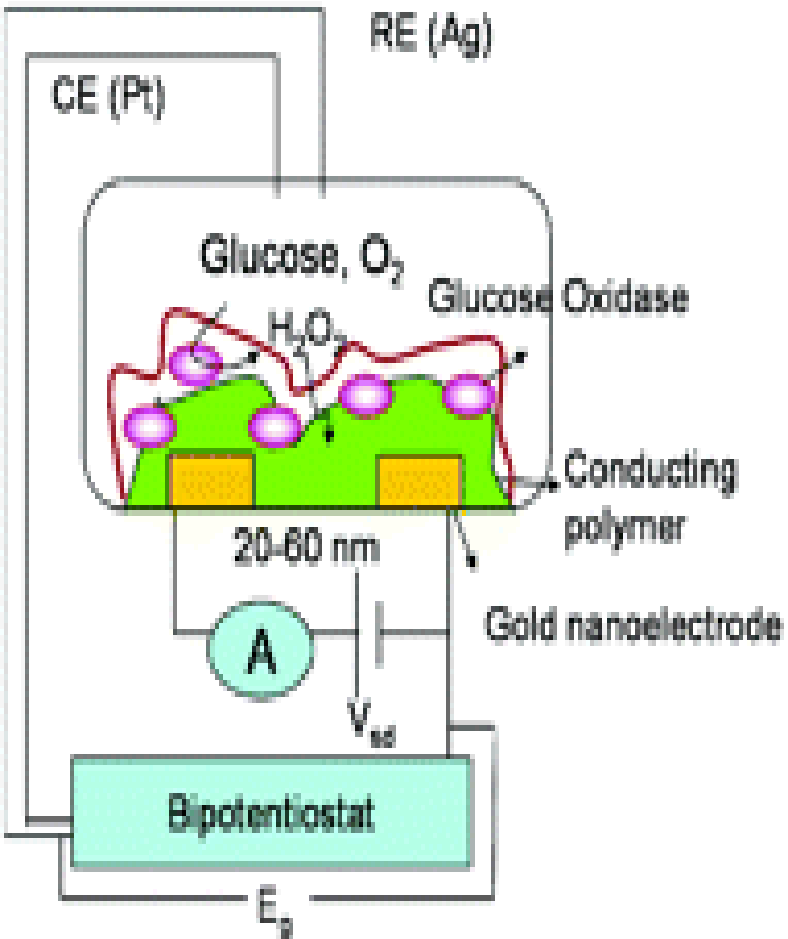

Blood Glucose Nano-sensor

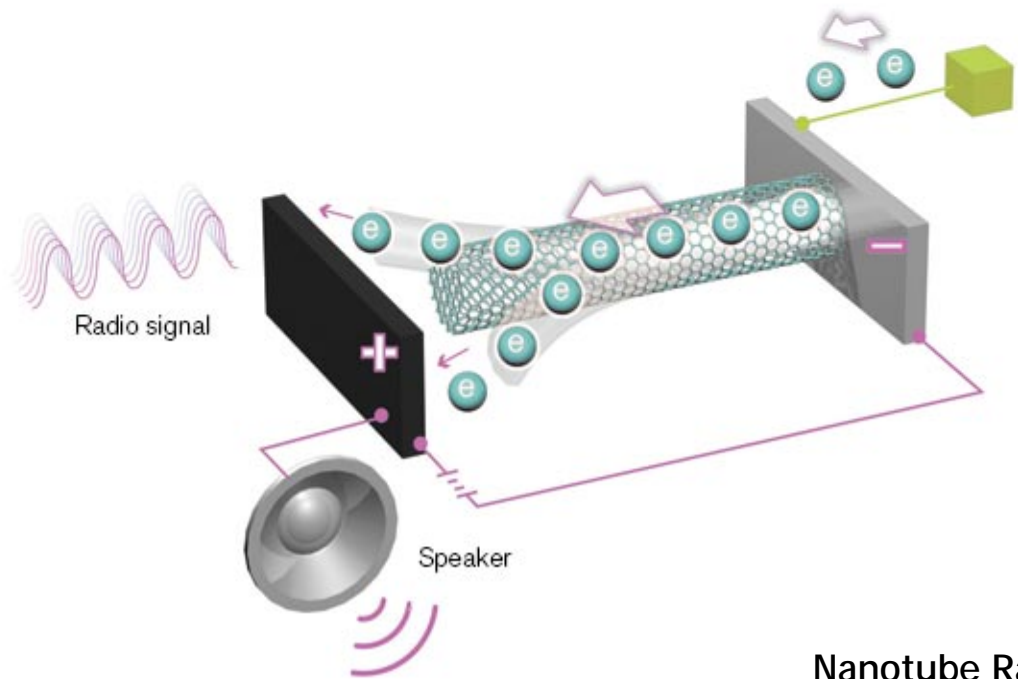
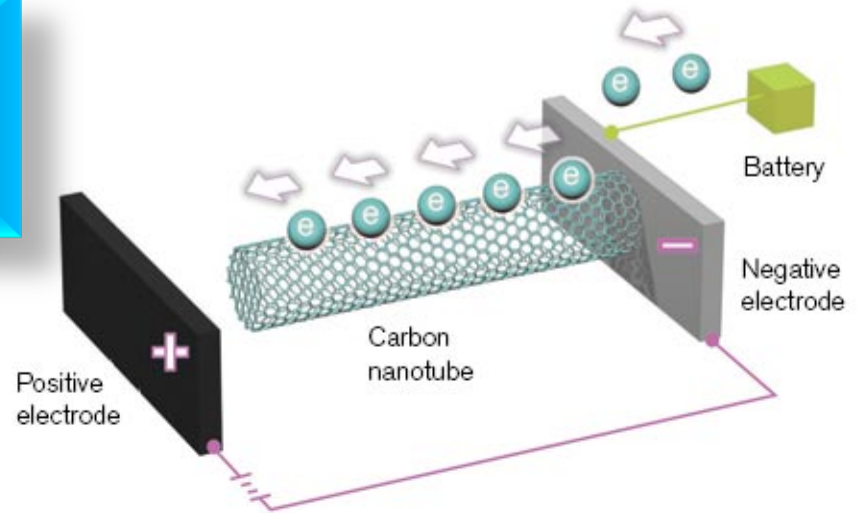

Nanotube Radio

# Integrated Glucose NanoSensor NanoRadio

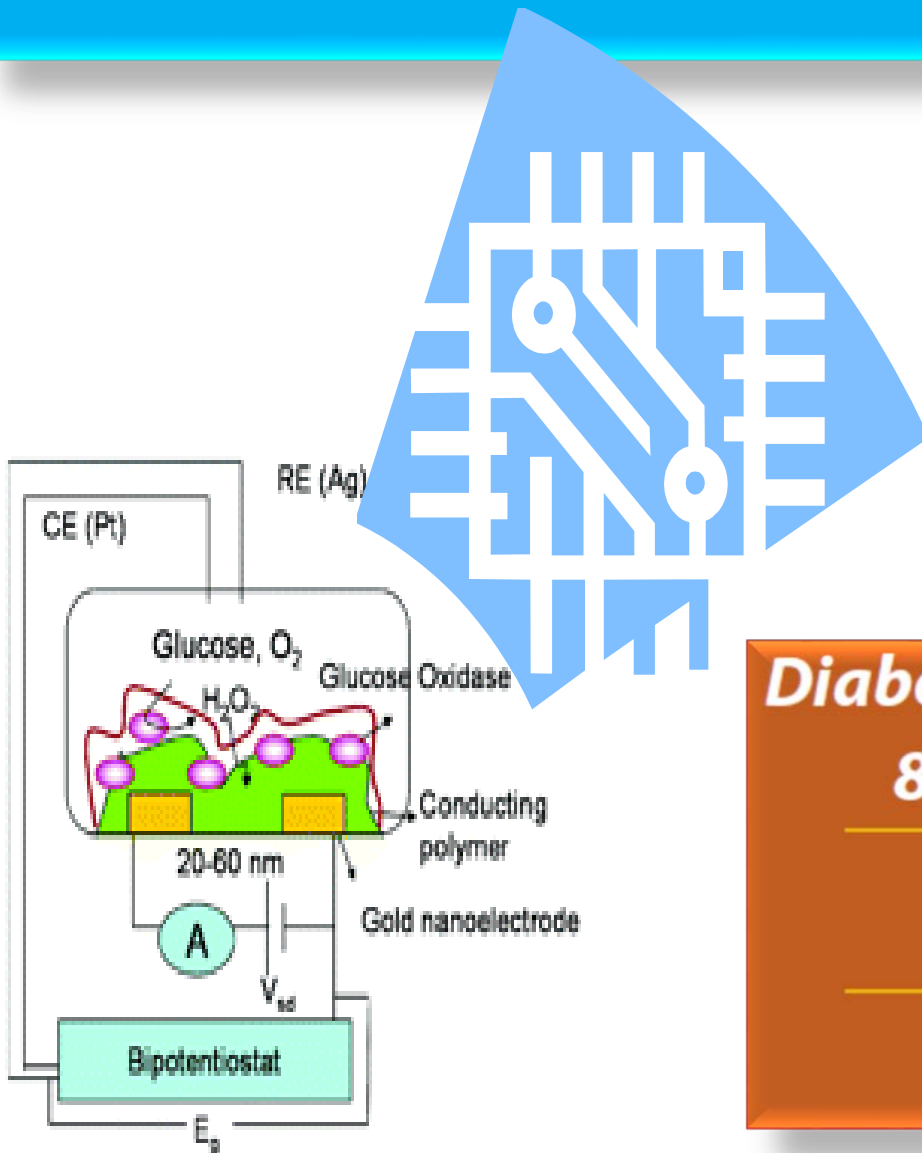

**Diabetes affects 25.8 million people  
8.3% of the U.S. population**

**DIAGNOSED  
18.8 million people**

**UNDIAGNOSED  
7.0 million people**

# Industrial Internet of Remote Health Monitoring

*May I implant a glucose nano-sensor nano-radio chip on your shoulder? You are fat. You could become diabetic.*

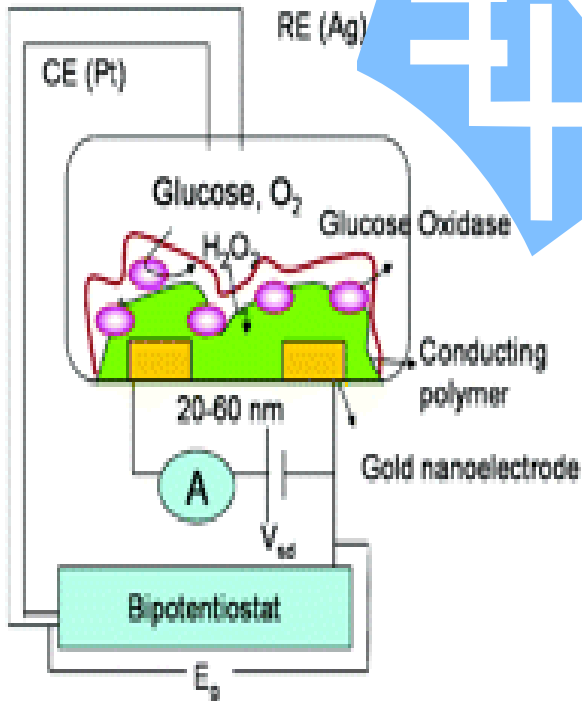

Prime Minister Bertie Ahern (Taoiseach) 2005 at TCD, IRL

# Glucose NanoSensor NanoRadio ecosystem of health-care monitoring

About 30 million individuals in US affected by diabetes

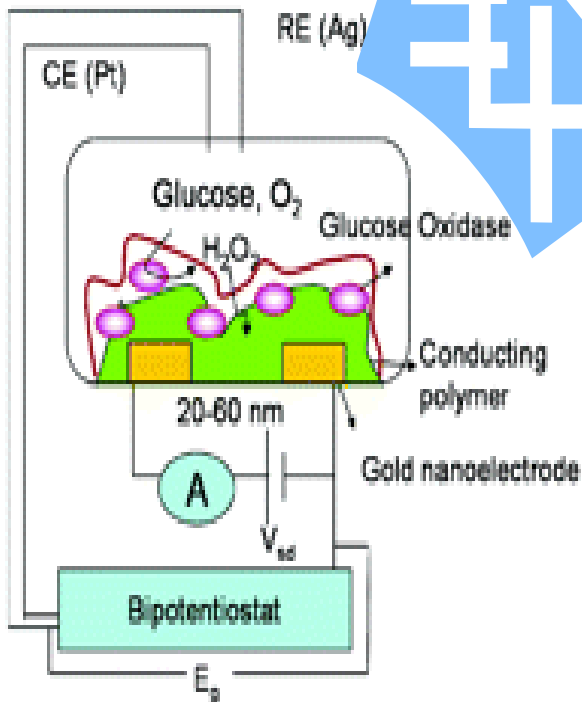

1. Implanted wireless sensor transmits blood glucose data from home or office or airport (WiFi/WAN/gateway)
2. Data travels from you to your hospital or clinic (MAN)
3. Blood glucose data updates risk and patient profile
4. If you need medical attention or insulin or other treatment then auto-responder sends message or calls



# Glucose NanoSensor NanoRadio ecosystem of health-care monitoring may have a minor economic impact

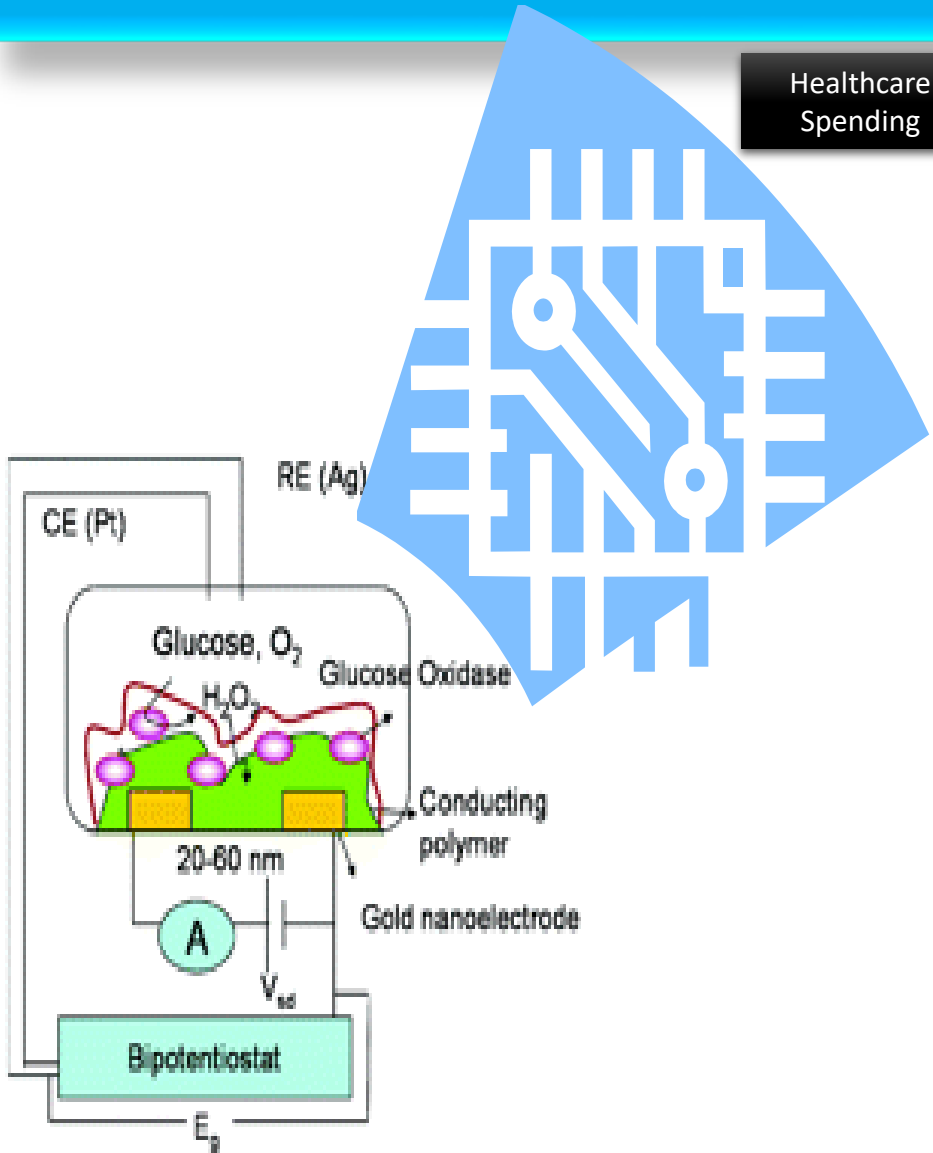

Healthcare Spending

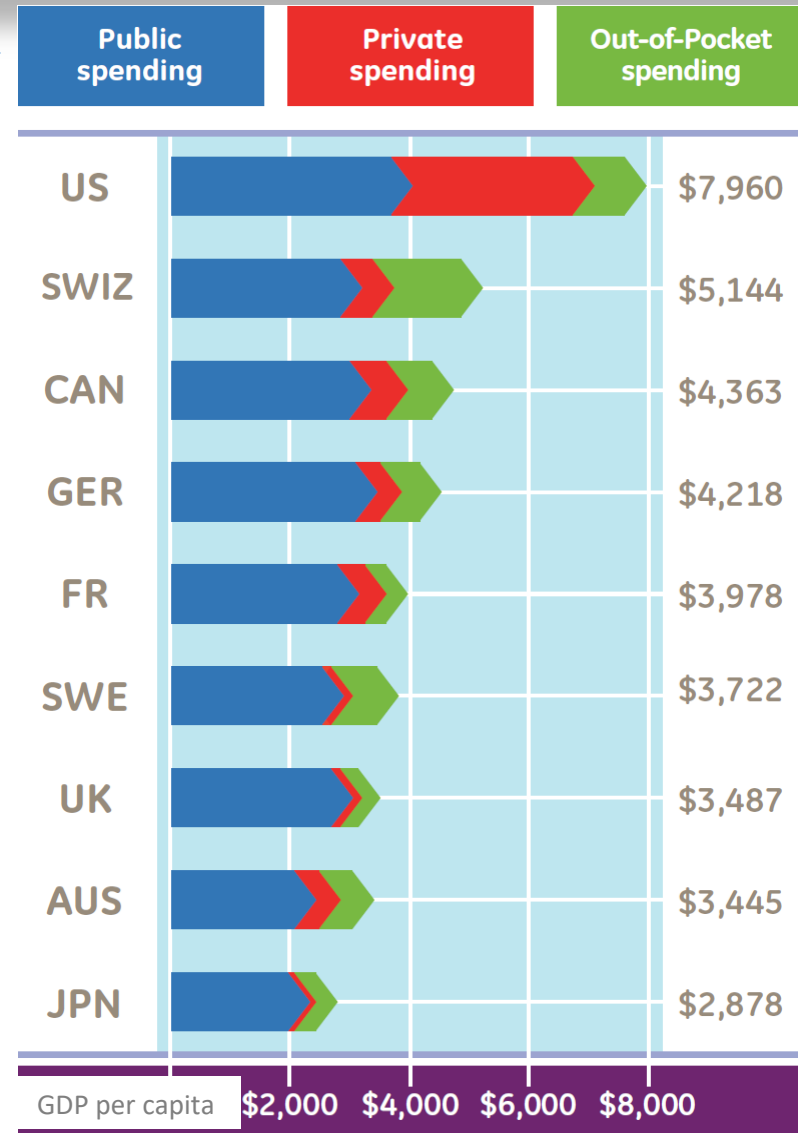



Yuan T. Lee Charlie Townes

Glenn Seaborg

Helene Langevin Joliot-Curie

Shoumen Datta

Dudley Herschbach

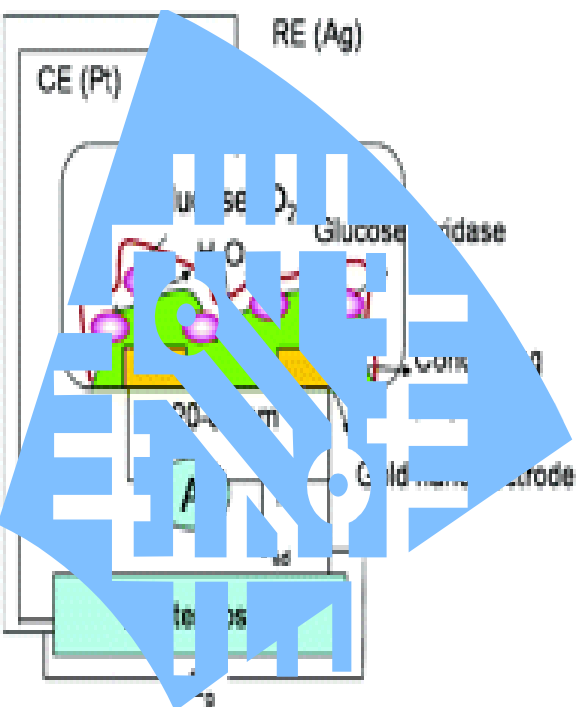

802.11b  
WiFi  
802.11g



802.16a

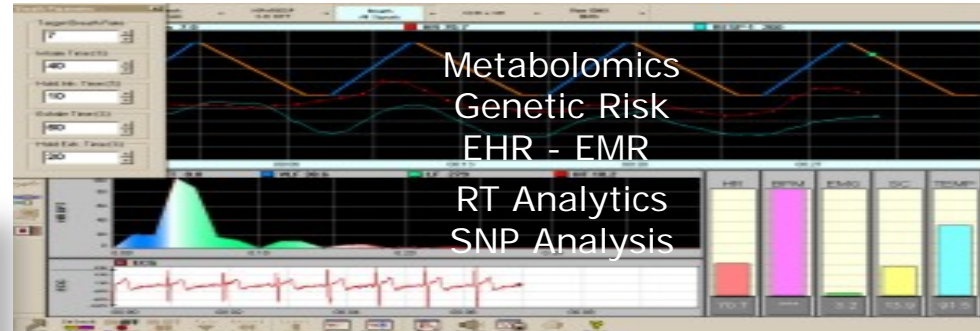
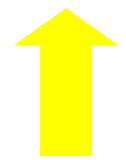

Improved healthcare services, savings, create jobs from new products, new services and potential to create as well as capture new emerging markets of billions (BRICS)

Changes to be ushered in by the connectivity potential from the IoT will shape the global economy in ways which could be limited only by our imagination

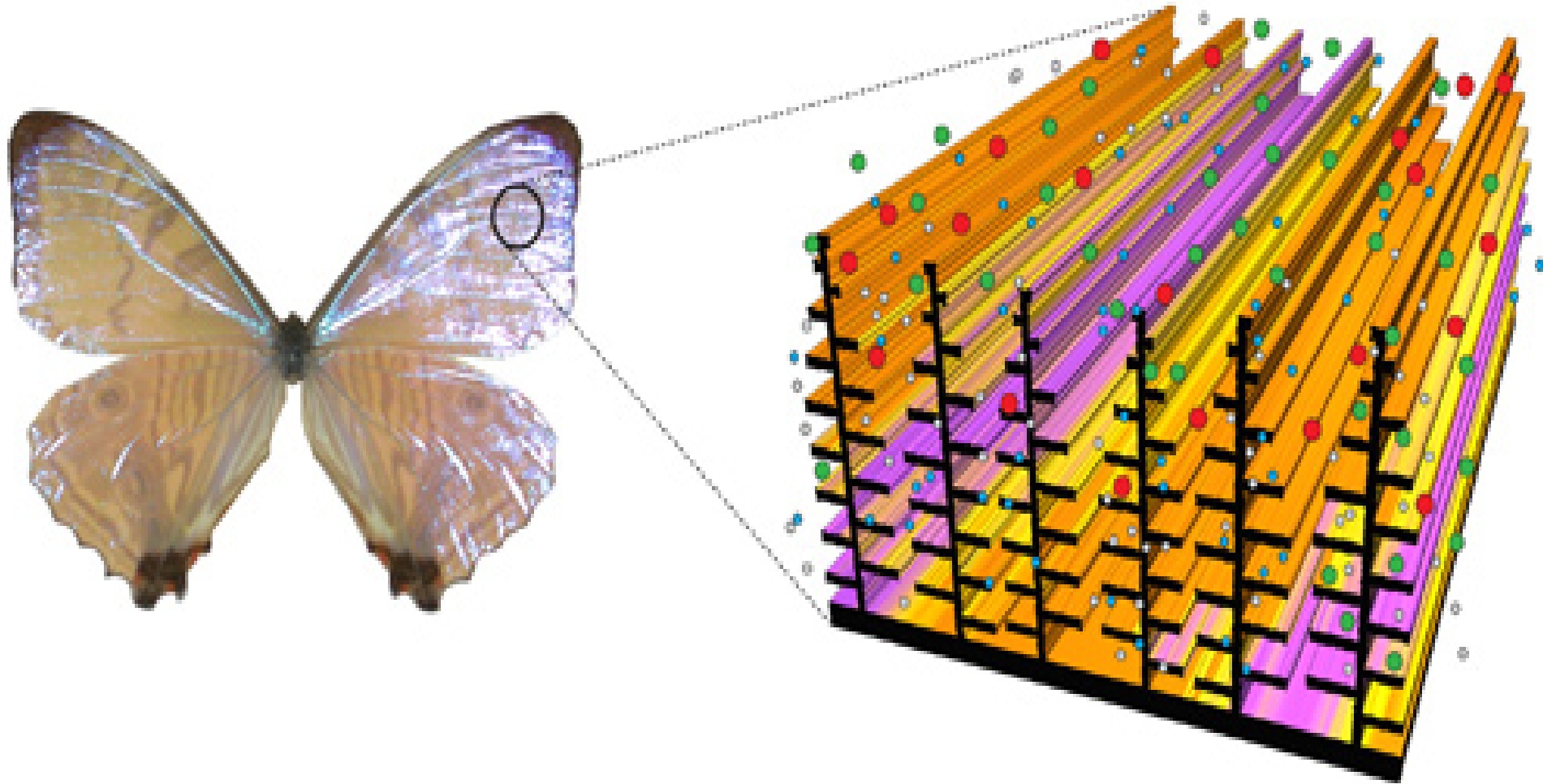

*Scientists at GE Global Research discovered that the nanostructures on the wing scales of Morpho butterflies have excellent sensing capabilities. They could allow them to build sensors that can detect heat and also as many as 1,000 different chemicals. Image: GE Global Research*

# Can Butterflies Help Prevent Diabetes?

*This is only a suggestion by the author and not a fact or system which is under investigation or is available at present.*

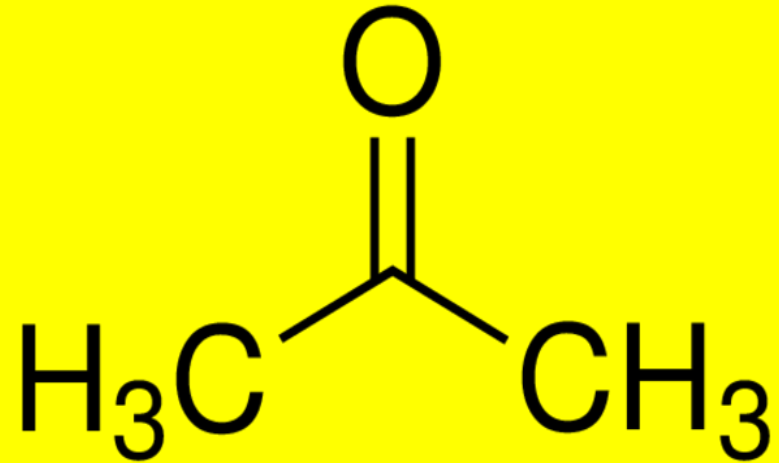
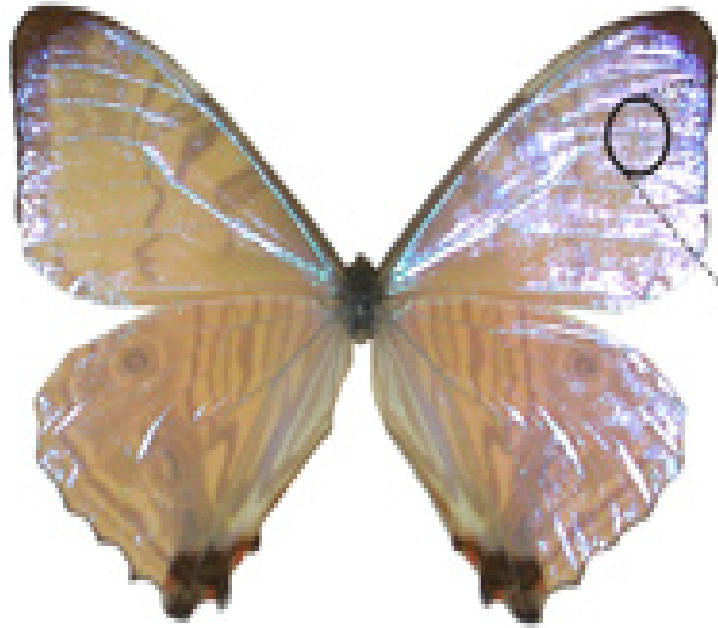

Dual Acetone Sensors on a single chip may differentiate between acetone in the environment vs acetone in the blood, breath or urine of diabetics. Subtractive analysis alerts to blood ketones. Occurs when body uses fat instead of glucose. It signals insulin dysfunction. If undiagnosed, it may lead to diabetic ketoacidosis (DKA) which may result in diabetic coma and may be fatal. The acetone (ketone bodies) sensors may be able to detect trace levels (nano milli moles eq) and may help preventive care to stem the clinical onset of type II diabetes mellitus (glucose >120 mg/dl).

# MIoT Diabetes Management - Artificial Pancreas Device Systems

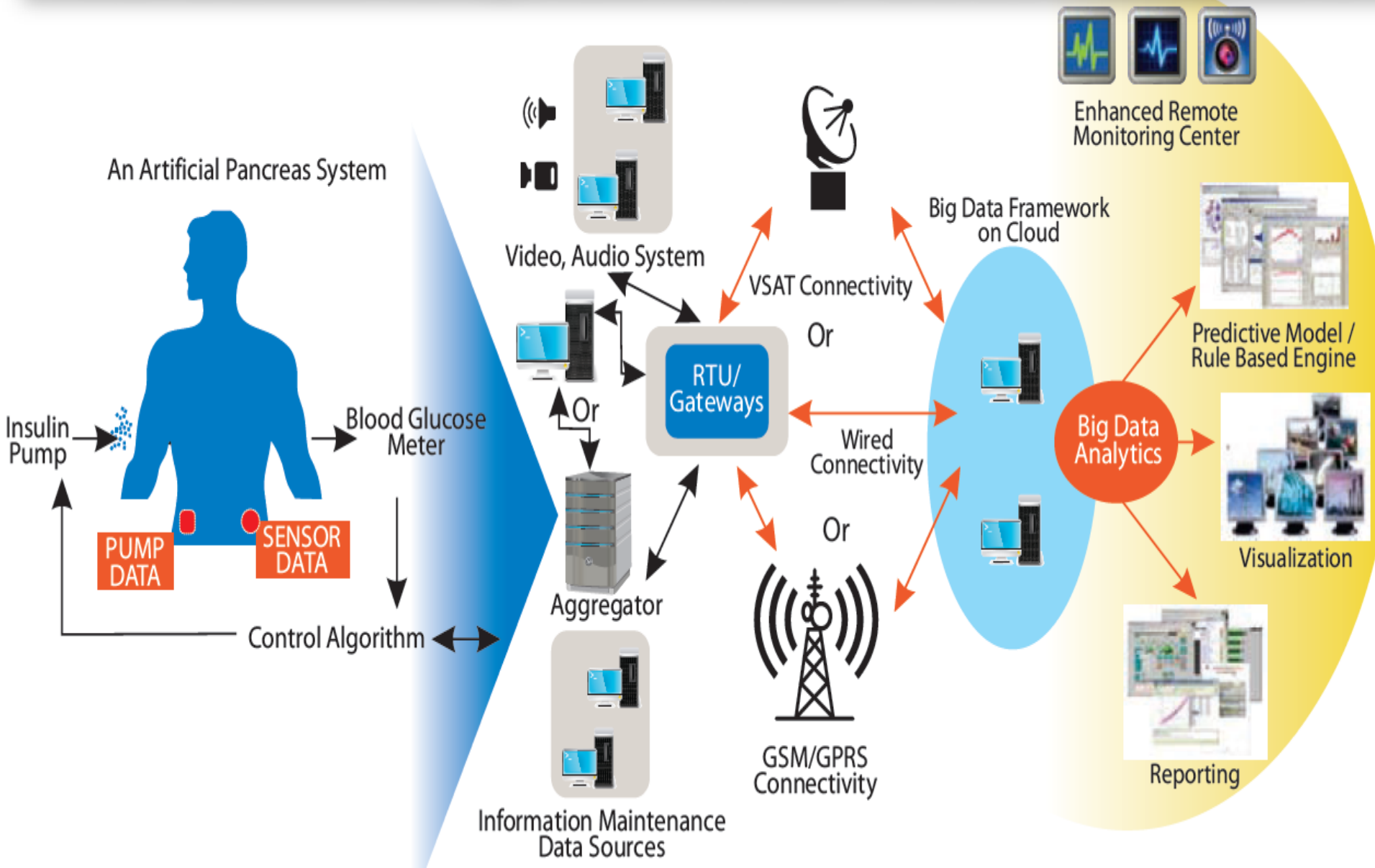

# Congestive Heart Failure

*Why should CHF claim about 5 million lives in the US?*

- About 5.1 million people in the United States have heart failure.
- About half of people with CHF die within 5 years of diagnosis.
- CHF costs the nation an estimated \$32 billion each year.

Abundance of prognostic biochemical markers –

- C-reactive protein (CRP5 / CRP6) – 1954 and Framingham Heart Study
- Tumour necrosis factor alpha (TNF $\alpha$ )
- Brain Natriuretic Peptide (1981) BNP <100 pg/ml CHF unlikely and >400 pg/ml CHF likely
- N-terminal (NT) pro-BNP <300 pg/ml CHF unlikely and >400-900 pg/ml CHF likely (age related)

**48,629 patients of acute decompensated heart failure found linear correlation between BNP levels and in hospital mortality. Failure of BNP to decline during hospitalization predicts death and re-hospitalization while discharge levels of 250pg/ml or less predicts event free survival.**

# Lab on a Chip - Detection of Non-Small Cell Lung Cancer (C) and Ovarian Cancer (D)

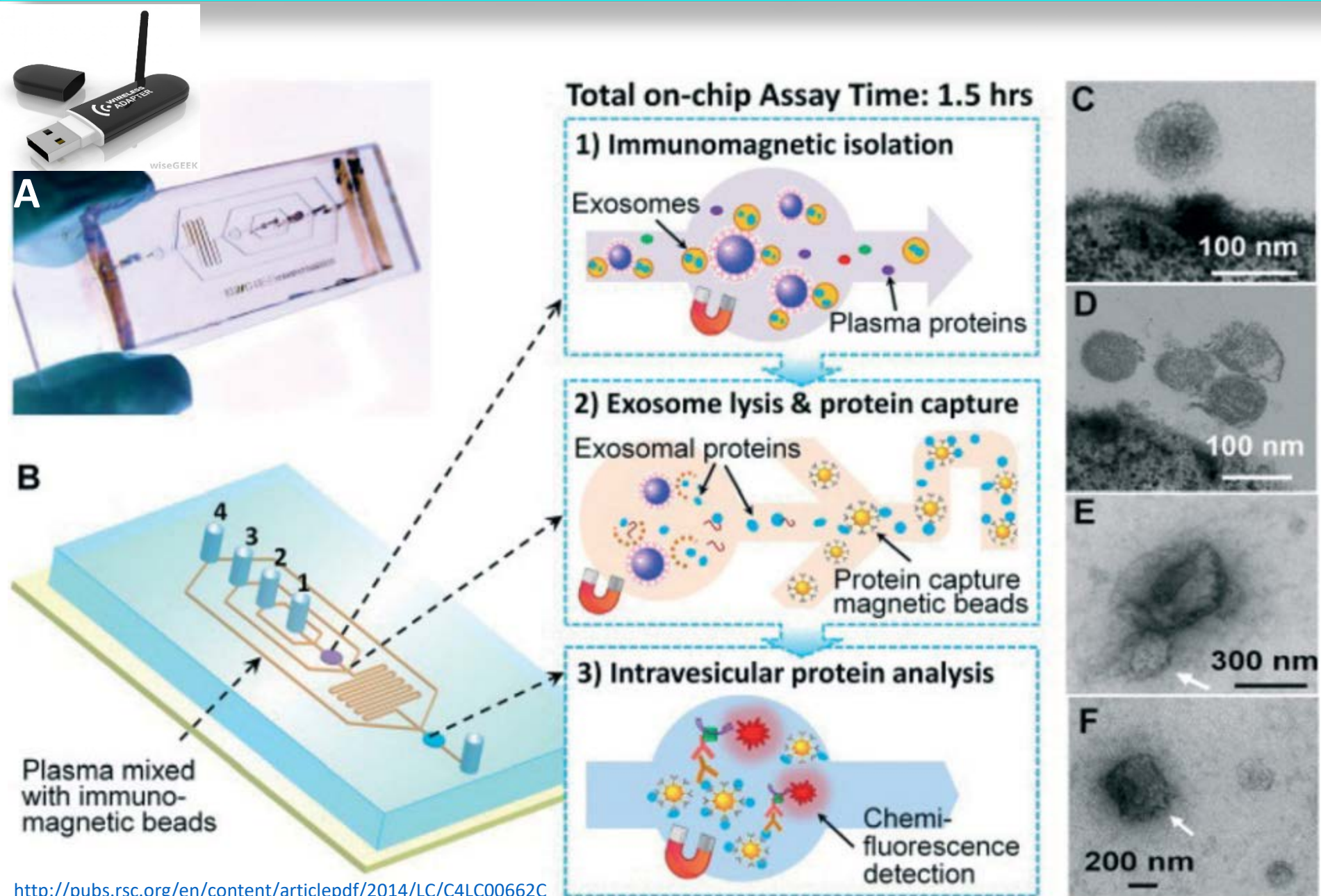

Biopsy is an important diagnostic tool for a broad range of conditions. Cancer diagnoses, for example, are confirmed using tissue explanted with biopsy. Here we demonstrate a miniaturized wireless sensor that can be implanted during a biopsy procedure and return chemical information from within the body. Power and readout are wireless *via* weak magnetic resonant coupling to an external reader. The sensor is filled with responsive nuclear magnetic resonance (NMR) contrast agents for chemical sensitivity, and on-board circuitry constrains the NMR measurement to the contents. This sensor enables longitudinal monitoring of the same location, and its simple readout mechanism is ideal for applications not requiring the spatial information available through imaging techniques. We demonstrated the operation of this sensor by measuring two metabolic markers, both *in vitro* and *in vivo*: pH in flowing fluid for over 25 days and in a xenograft tumor model in mice, and oxygen in flowing gas and in a rat hind-limb constriction experiment. The results suggest that this *in vivo* sensing platform is generalizable to other available NMR contrast agents. These sensors have potential for use in biomedicine, environmental monitoring and quality control applications.

## Miniaturized, biopsy-implantable chemical sensor with wireless, magnetic resonance readout

[C. C. Vassiliou](#),<sup>ab</sup> [V. H. Liu](#)<sup>ab</sup> and [M. J. Cima](#)<sup>\*ac</sup>

[Show Affiliations](#)

*Lab Chip*, 2015, **15**, 3465-3472

DOI: 10.1039/C5LC00546A





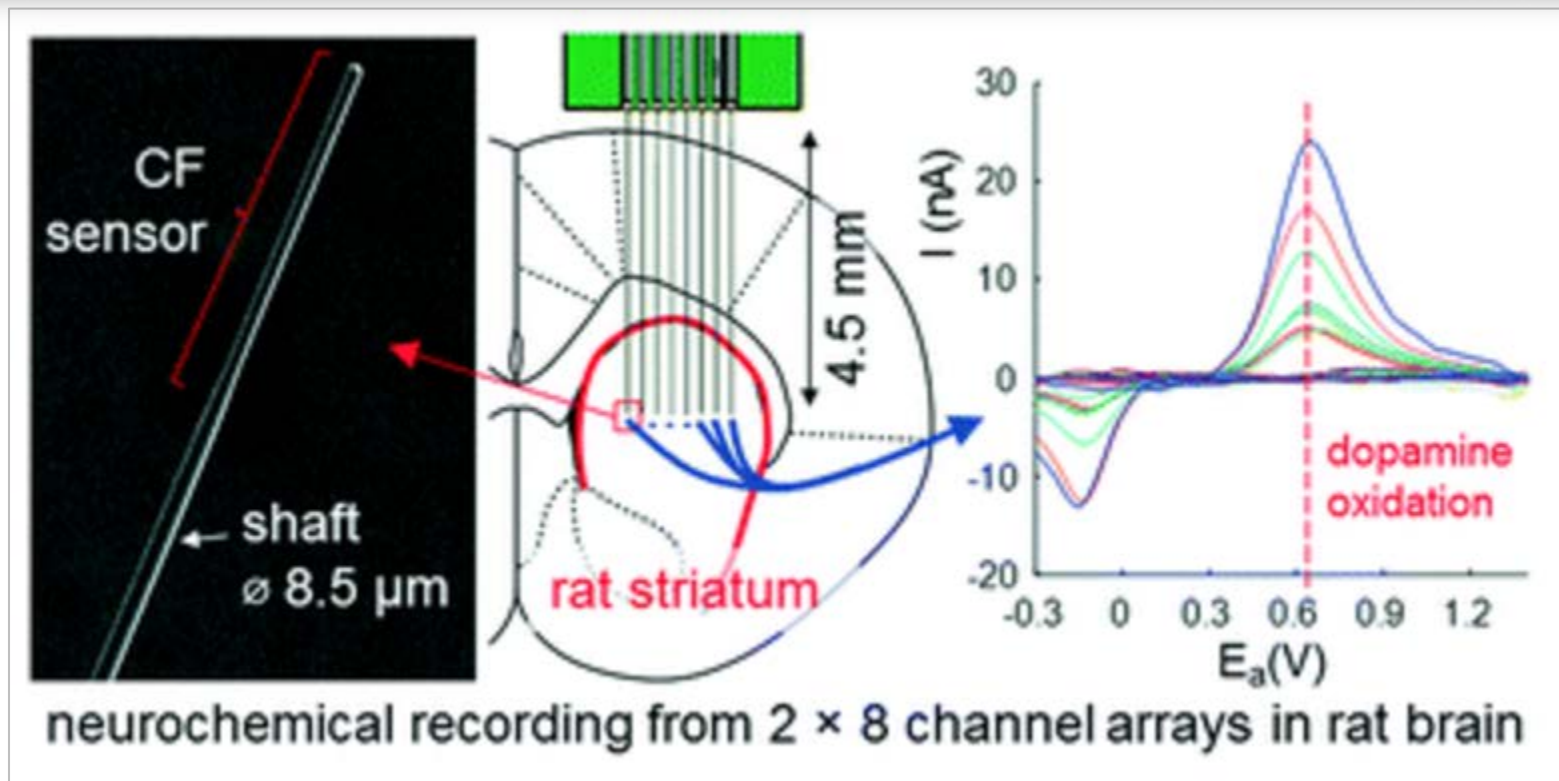

### Subcellular probes for neurochemical recording from multiple brain sites

Helen N. Schwerdt,<sup>ab</sup> Min Jung Kim,<sup>b</sup> Satoko Amemori,<sup>b</sup>  
Daigo Homma,<sup>b</sup> Tomoko Yoshida,<sup>b</sup> Hideki Shimazu,<sup>b</sup>  
Harshita Yerramreddy,<sup>b</sup> Ekin Karasan,<sup>b</sup> Robert Langer,<sup>ac</sup>  
Ann M. Graybiel<sup>b</sup> and Michael J. Cima<sup>\*ad</sup>

Show Affiliations

*Lab Chip*, 2017, Advance Article

DOI: 10.1039/C6LC01398H

Received 11 Nov 2016, Accepted 08 Feb 2017

First published online 15 Feb 2017

With the global rise in incidence of cancer & infectious diseases, there is a need for the development of techniques to diagnose, treat, and monitor these conditions. The ability to efficiently capture and isolate cells and other biomolecules from peripheral blood for downstream analyses is necessary. Graphene oxide (GO) is an attractive template nano-material for such biosensing applications.

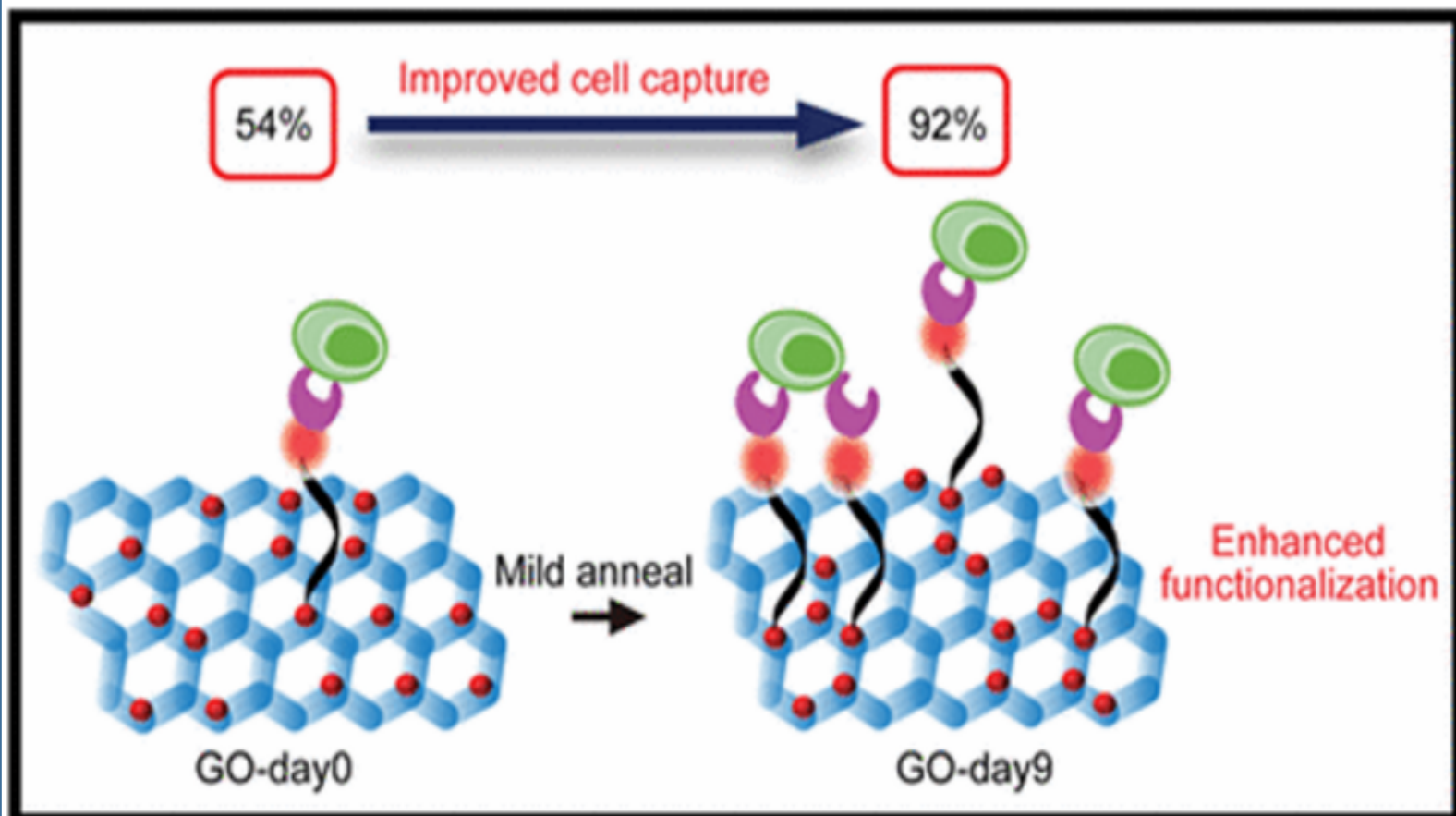

Favorable properties include its 2D architecture and wide range of functionalization chemistries, to tailor affinity toward aromatic functional groups. A limitation of current techniques is that as-synthesized GO nano-sheets are used directly in applications, and the benefits of their structural modification on the device performance have remained unexplored. We report a microfluidic-free, sensitive, planar device on treated GO substrates to enable quick and efficient capture of Class-II MHC-positive cells from murine blood. We achieve this by using a mild thermal annealing treatment on GO substrates, which drives a phase transformation through oxygen clustering.

### Enhanced Cell Capture on Functionalized Graphene Oxide Nanosheets through Oxygen Clustering

Neelkanth M. Bardhan<sup>†‡§¶</sup>, Priyank V. Kumar<sup>†¶</sup>, Zeyang Li<sup>¶</sup>, Hidde L. Ploegh<sup>¶</sup>, Jeffrey C. Grossman<sup>†\*</sup>, Angela M. Belcher<sup>†‡§</sup>, and Guan-Yu Chen<sup>¶#</sup>

<sup>†</sup> Department of Materials Science and Engineering, Massachusetts Institute of Technology, Cambridge, Massachusetts 02139, United States

<sup>‡</sup> Department of Biological Engineering, Massachusetts Institute of Technology, Cambridge, Massachusetts 02139, United States

<sup>§</sup> The Koch Institute for Integrative Cancer Research, Massachusetts Institute of Technology, Cambridge, Massachusetts 02139, United States

<sup>¶</sup> Whitehead Institute for Biomedical Research, Cambridge, Massachusetts 02139, United States

<sup>‡</sup> Department of Biology, Massachusetts Institute of Technology, Cambridge, Massachusetts 02139, United States

<sup>#</sup> Institute of Biomedical Engineering, National Chiao Tung University, Hsinchu 30010, Taiwan

<sup>¶</sup> Department of Biological Science and Technology, National Chiao Tung University, Hsinchu 30010, Taiwan

ACS Nano, 2017, 11 (2), pp 1548–1558

DOI: 10.1021/acsnano.6b06979

Publication Date (Web): January 13, 2017

Copyright © 2017 American Chemical Society

\*E-mail: jcg@mit.edu. †E-mail: belcher@mit.edu. ‡E-mail: quanvu@nctu.edu.tw.

# Single-molecule detection of protein efflux from microorganisms using fluorescent single-walled carbon nanotube sensor arrays

Markita Patricia Landry, Hiroki Ando, Allen Y. Chen, Jicong Cao, Vishal Isaac Kottadiel, Linda Chio, Darwin Yang, Juyao Dong, Timothy K. Lu & Michael S. Strano

**Affiliations** | **Contributions** Department of Chemical Engineering, Massachusetts Institute of Technology

*Nature Nanotechnology* (2017) | doi:10.1038/nnano.2016.284

Received 20 January 2016 | Accepted 01 December 2016 | Published online 23 January 2017

Department of Chemical and Biomolecular Engineering, University of California Berkeley, Berkeley, California 94720, USA  
Markita Patricia Landry, Linda Chio & Darwin Yang

California Institute for Quantitative Biosciences (qb3), University of California-Berkeley, Berkeley, California 94720, USA  
Markita Patricia Landry

Department of Electrical Engineering & Computer Science and Department of Biological Engineering, Massachusetts Institute of Technology, Cambridge, Massachusetts 02139, USA  
Hiroki Ando, Allen Y. Chen, Jicong Cao & Timothy K. Lu

MIT Synthetic Biology Center, Massachusetts Institute of Technology, Cambridge, Massachusetts 02139, USA  
Hiroki Ando, Allen Y. Chen, Jicong Cao & Timothy K. Lu

Biophysics Program, Harvard University, Cambridge, Massachusetts 02138, USA  
Allen Y. Chen

The Rowland Institute at Harvard University, Cambridge, Massachusetts 02142, USA  
Vishal Isaac Kottadiel

A distinct advantage of nanosensor arrays is their ability to achieve ultralow detection limits in solution by proximity placement to an analyte. Here, we demonstrate label-free detection of individual proteins from *Escherichia coli* (bacteria) and *Pichia pastoris* (yeast) immobilized in a microfluidic chamber, measuring protein efflux from single organisms in real time.

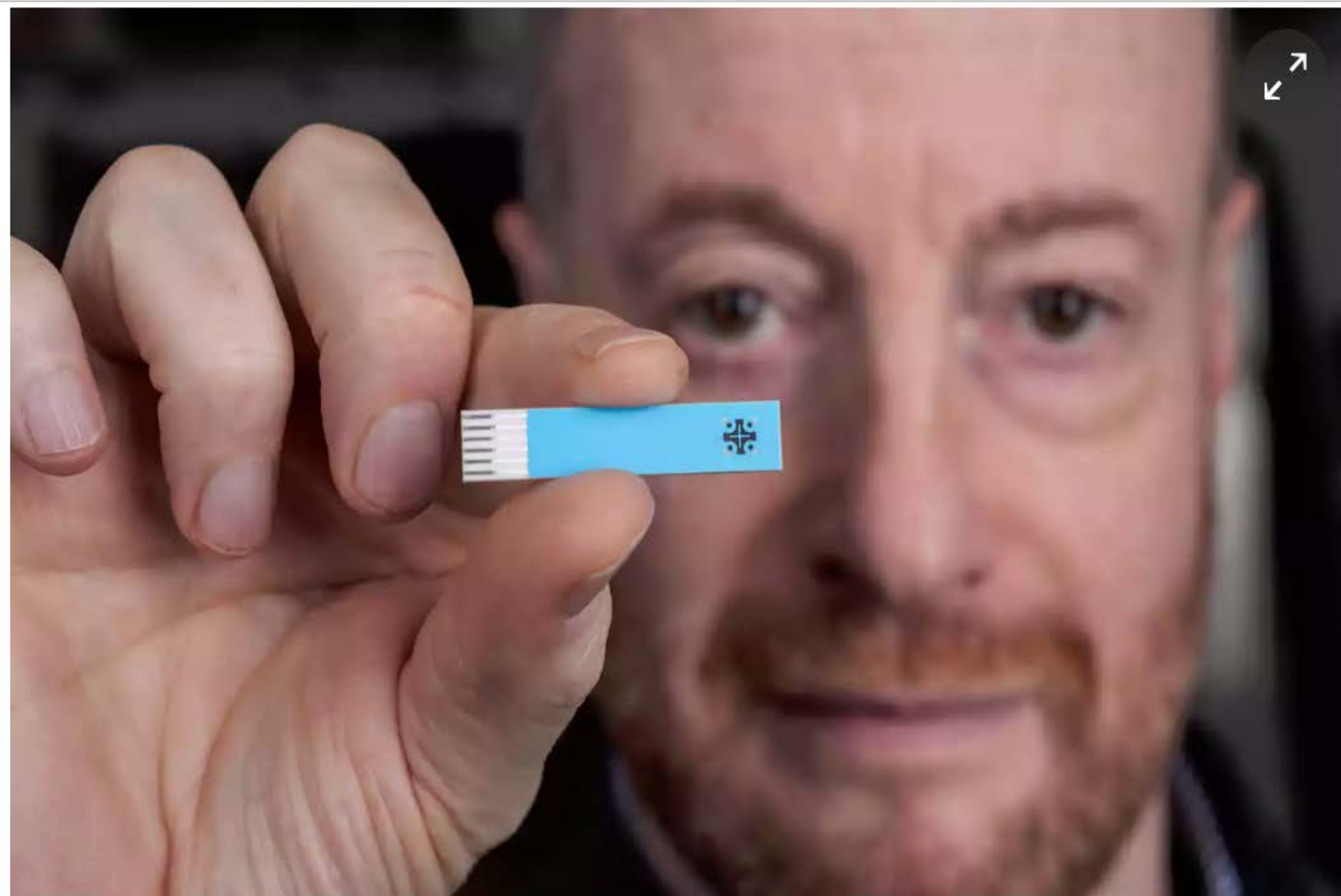

**i** Nicholas Dale with his SMARTchip **STROKE DETECTOR – BIOSENSOR**

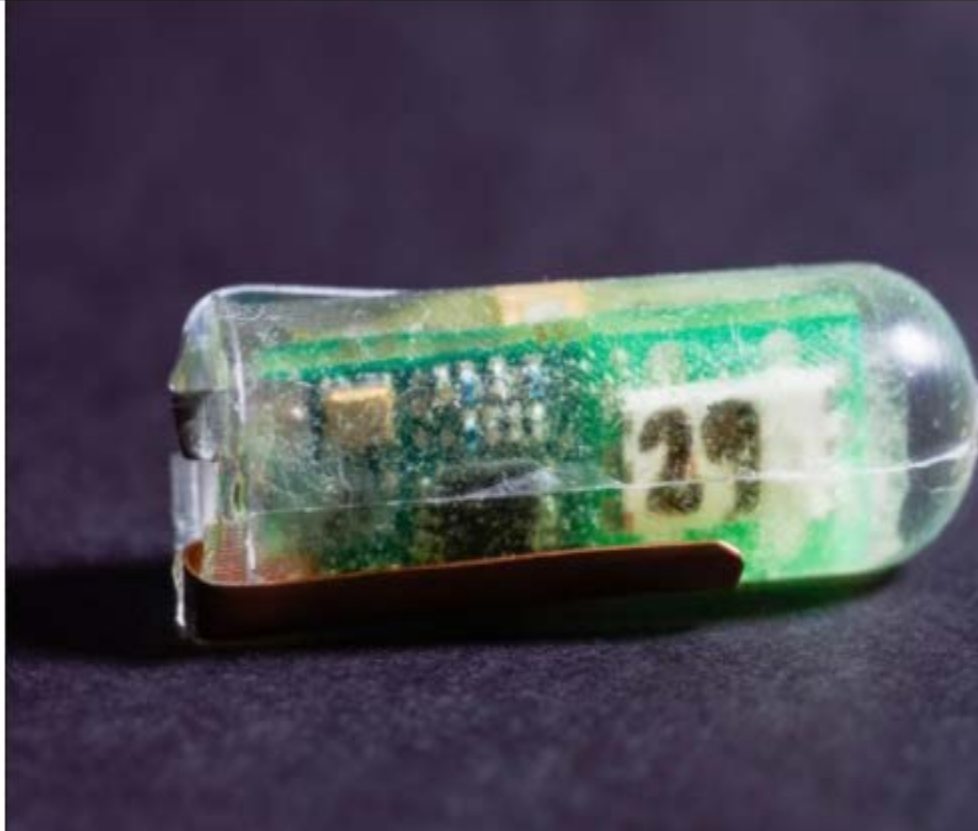

Dr Phillip Nadeau with the "silver bullet" device, which could revolutionise medical treatment (Photo: Andrew)

Researchers at MIT and Brigham and Women's Hospital have designed and demonstrated a small, ingestible voltaic cell that is sustained by the acidic fluids in the stomach.

Photo: Diemut Strebe

<http://news.mit.edu/2017/engineers-harness-stomach-acid-power-tiny-sensors-0206>

## Engineers harness stomach acid to power tiny sensors

Ingestible electronic devices could monitor physiological conditions or deliver drug

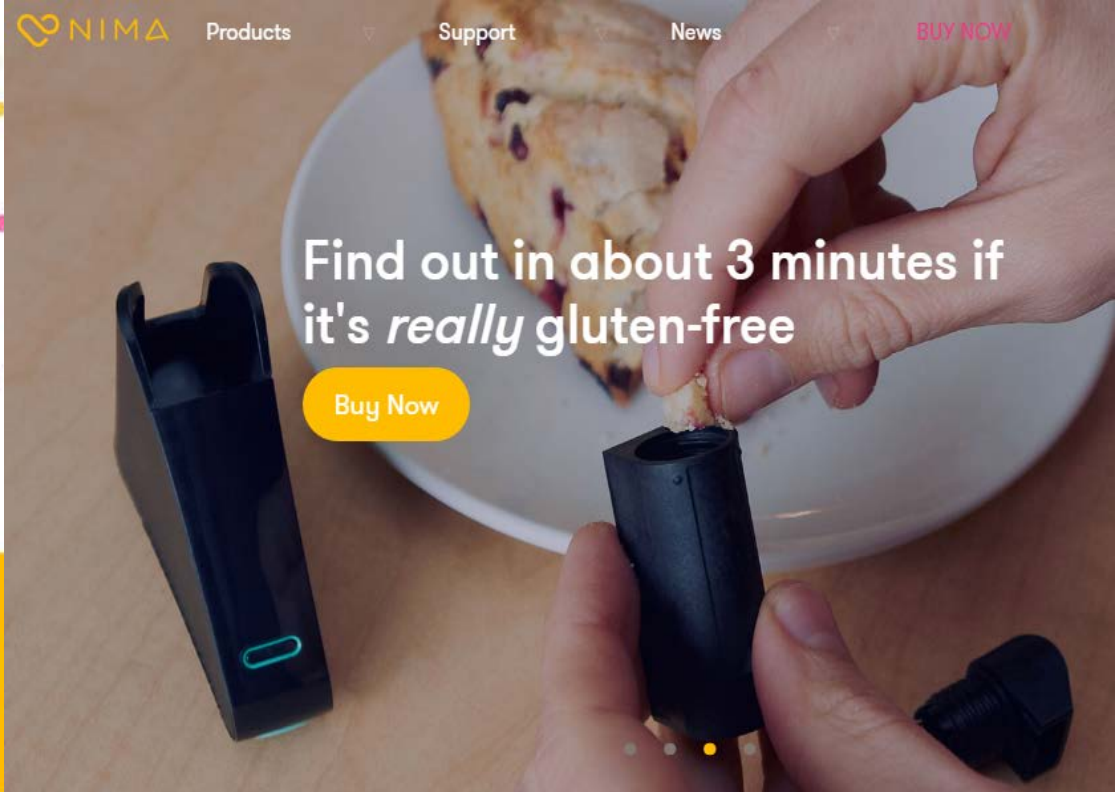

Find out in about 3 minutes if it's *really* gluten-free

Buy Now

The world's first portable gluten sensor  
Order yours at [nimasensor.com](https://nimasensor.com)

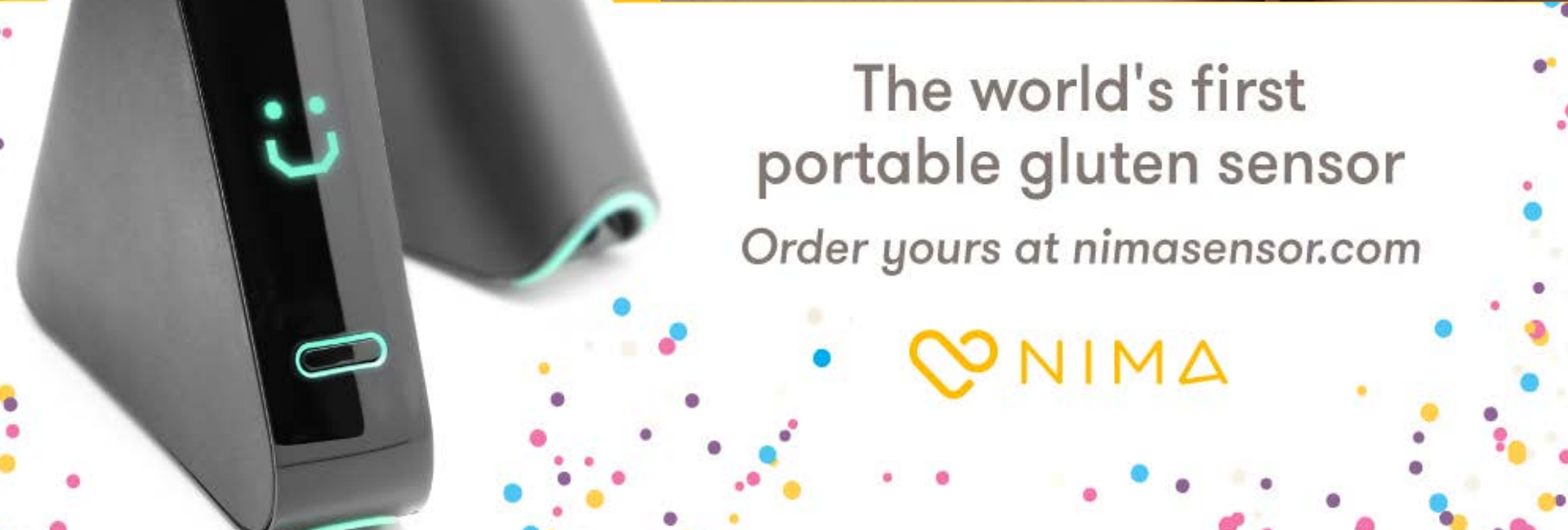

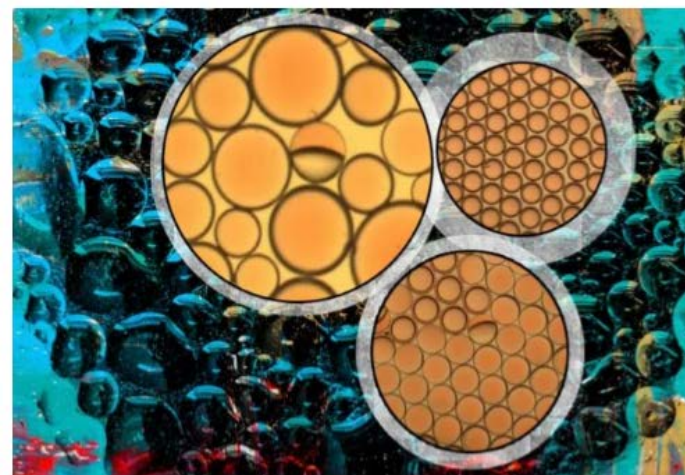

A simple way to make and reconfigure complex emulsions

Anne Trafton | MIT News Office  
February 25, 2015



## Janus Emulsions for the Detection of Bacteria

Qifan Zhang,<sup>†</sup> Suchol Savagatrup,<sup>†</sup> Paulina Kaplonek,<sup>‡,§</sup> Peter H. Seeberger,<sup>\*,‡,§</sup>  
and Timothy M. Swager<sup>\*,†,§</sup>

<sup>†</sup>Department of Chemistry and Institute for Soldier Nanotechnologies, Massachusetts Institute of Technology, 77 Massachusetts Avenue, Cambridge, Massachusetts 02139, United States

<sup>‡</sup>Department of Biomolecular Systems, Max Planck Institute of Colloids and Interfaces, Am Mühlenberg 1, 14476 Potsdam, Germany

<sup>§</sup>Institute of Chemistry and Biochemistry, Free University Berlin, Arnimallee 22, 14195 Berlin, Germany

Food Testing. Blood  
Testing? Sputum?  
Mucus? Fluids?

Specialized droplets interact with bacteria and can be analyzed using a smartphone.

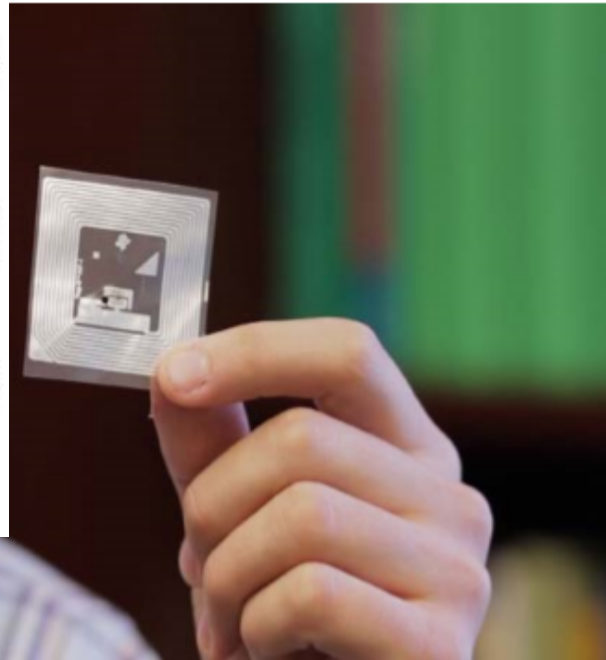
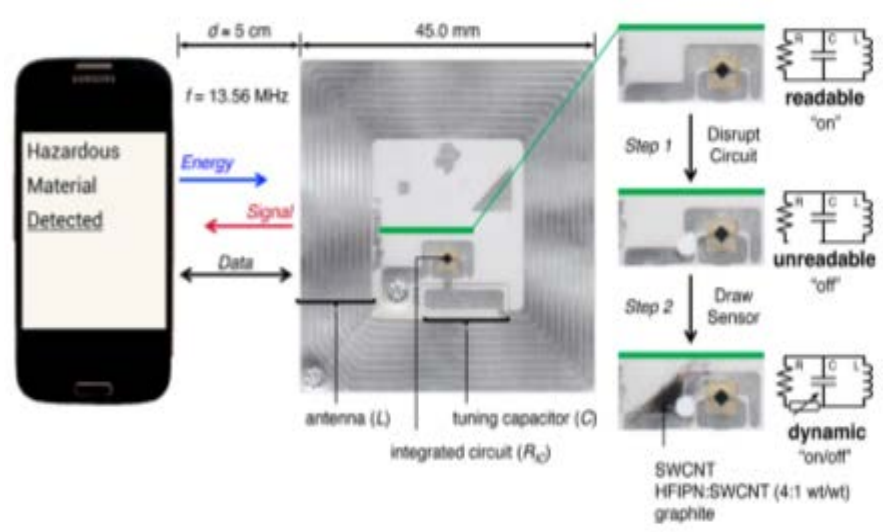

The MIT researchers' wireless chemical sensor.

Photo: Melanie Gonick



## Detecting gases wirelessly and cheaply

New sensor can transmit information on hazardous chemicals or food spoilage to a smartphone.

## Wireless gas detection with a smartphone via rf communication

Joseph M. Azzarelli, Katherine A. Mirica, Jens B. Ravnsbæk<sup>1</sup>, and Timothy M. Swager<sup>2</sup>

Department of Chemistry, Massachusetts Institute of Technology, Cambridge, MA 02139

Edited by Chad A. Mirkin, Northwestern University, Evanston, IL, and approved November 5, 2014 (received for review August 10, 2014)



# Pay 1c Per Analytics Apps, Data Distribution Service

Glucose Sensor



Cholesterol Sensor



BNP Sensor

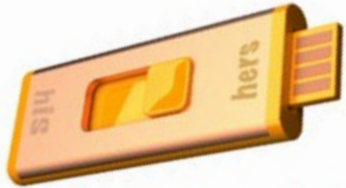

Stroke Sensor

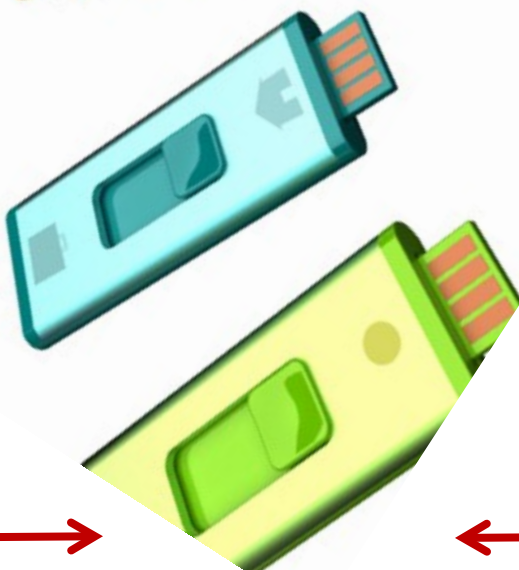

What does the data suggest about my health?



Hot swappable, modular, smart



NK Labs ARA Prototype



# Changes to be ushered in by the connectivity potential from the IoT will shape the global economy in ways which could be limited only by our imagination

Four months ago, 16-year-old John Wall had introduced the prototype of his Atmel powered OLED smartwatch. Earlier this week, the Maker revealed that the design was on its own power and completed.



**WALLTECH**

@walltechOSHW

<http://bit.ly/OS-ARDUINO>

Drum roll please.....My BT 4.0 arduino compatible smart watch is on its own power! My prototype is complete!

7:38 PM - 12 Oct 2014

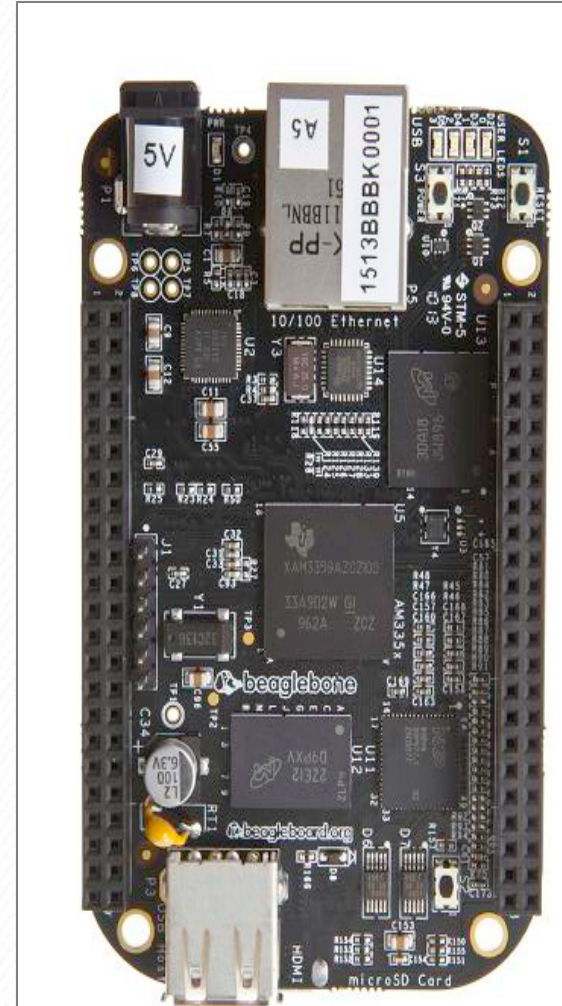

# Healthy Disruption?

*Printed Spare Parts ?*

# 3-D Printing

## Design of Prosthetics and Orthopedic Imaging

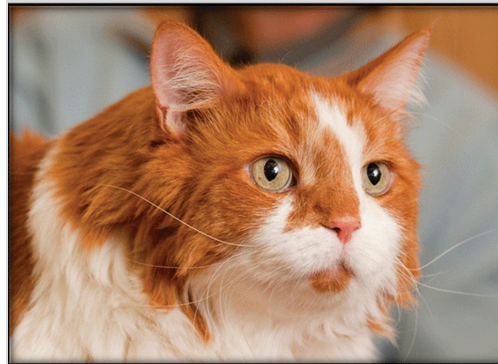
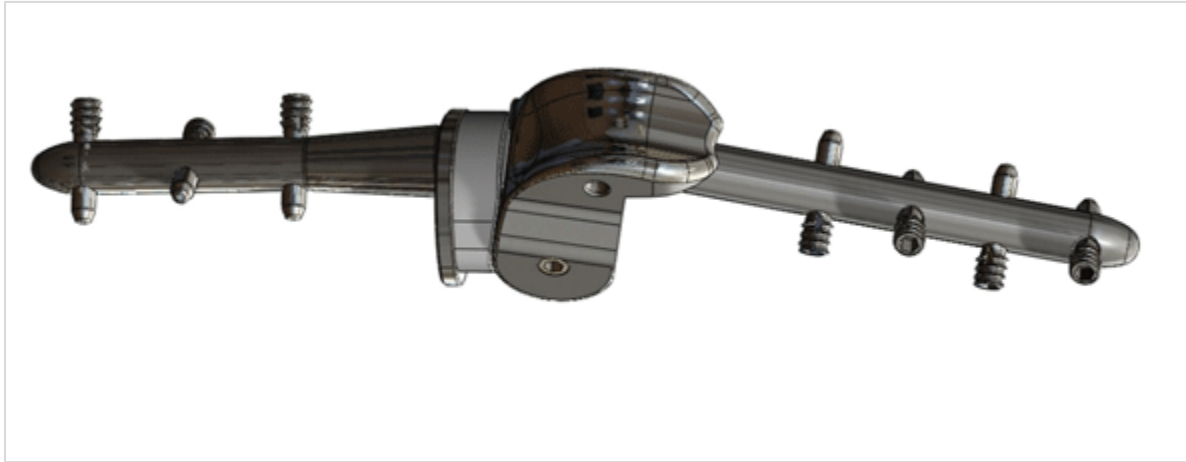

Cyrano L. Catte II (above) is the first feline to receive a total knee arthroplasty (TKA). Femoral and tibial components were created with direct metal laser sintering (EOS).

# 3-D Printing of Spare Parts

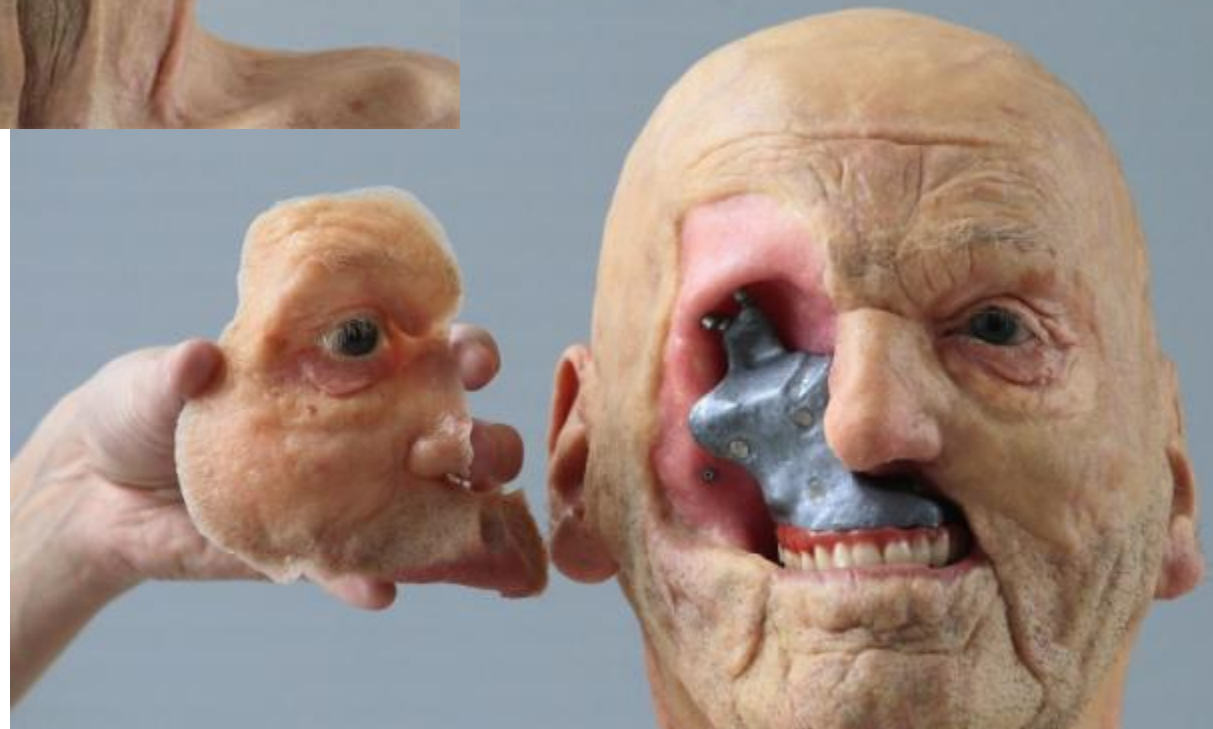
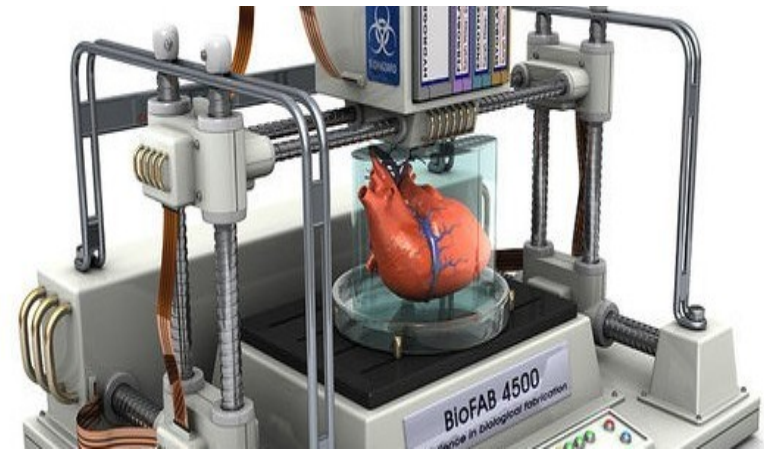

<http://bit.ly/3D-Print-A-Tooth>  
<http://bit.ly/3D-Print-Medical-Devices>

Artificial Skin with embedded sensory surface talks to smart phone via capacitive sensing using Touchcode adapted for printed i-Skin

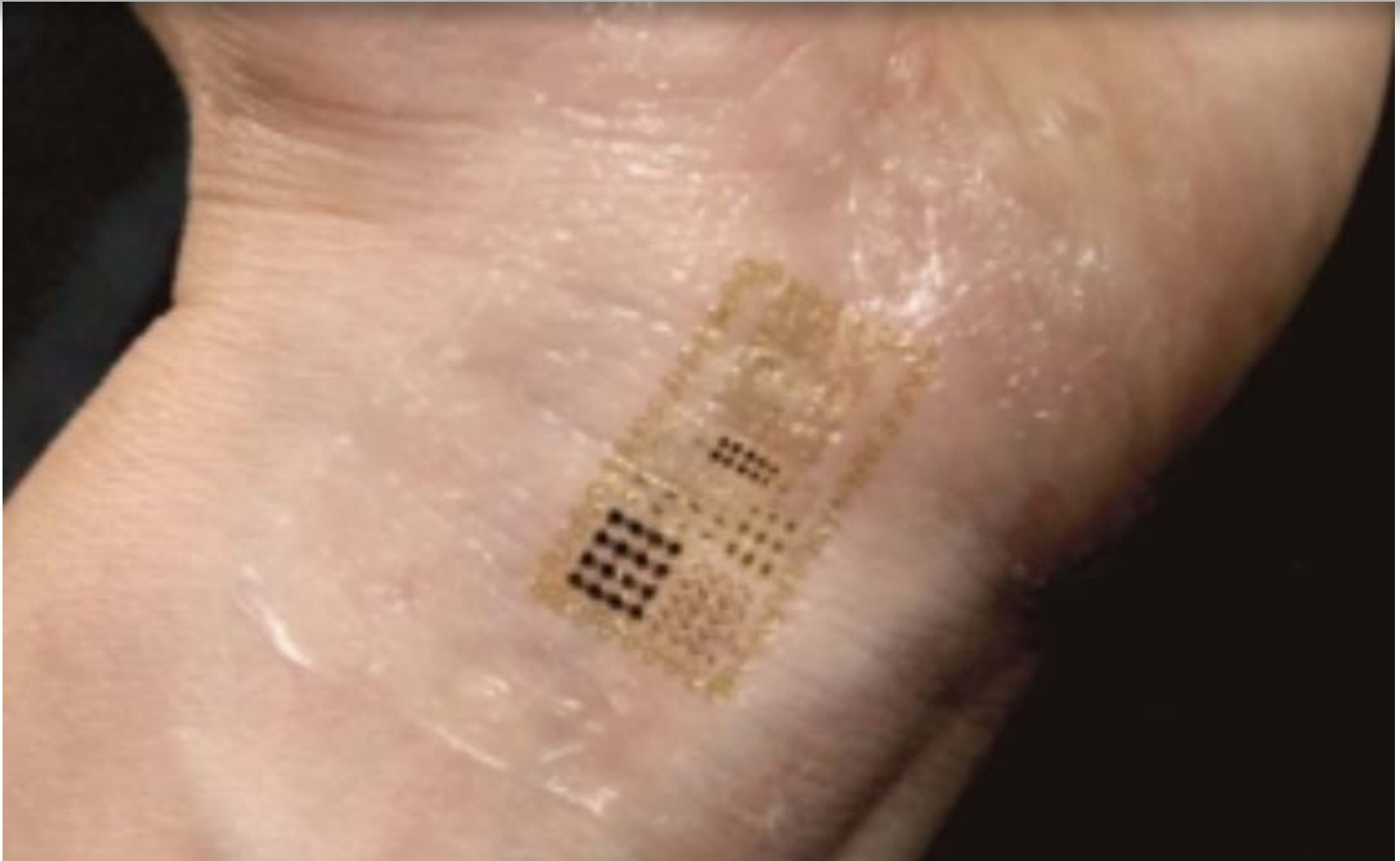

Your medicine can inform your doctor about its kinetics, bio-availability and side effects. It can alert your pharmacist about potential over-dose if multiple medications contain same or similar active ingredients. Your medicine can query and adjust dosage.

# Paradigm Shift in Global Healthcare Economics

## 3D Printed Medical Devices + OS Hardware / Software

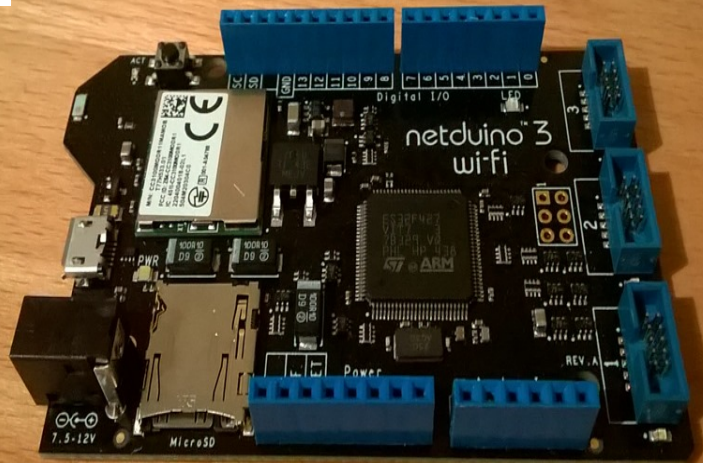
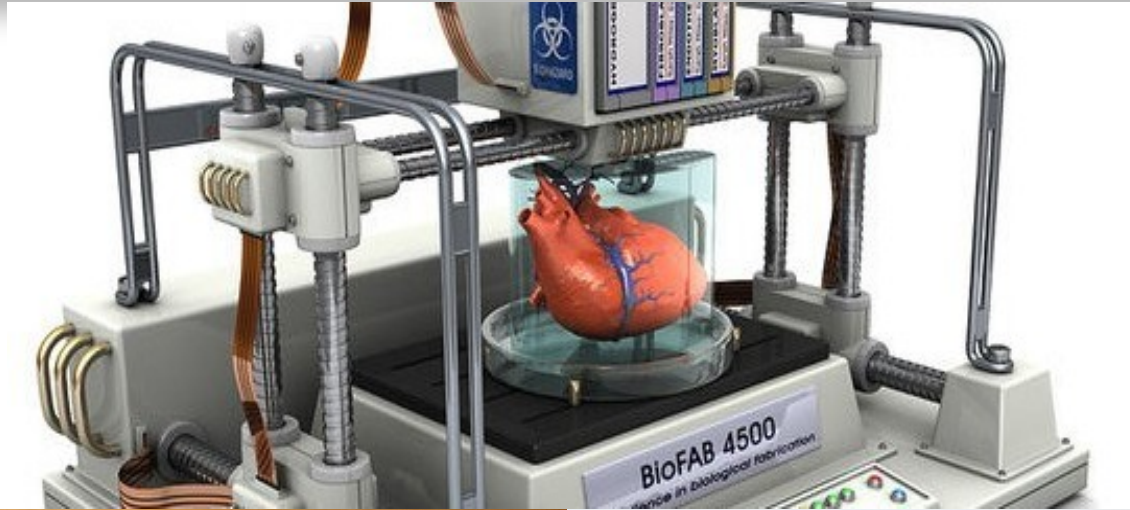

Complexity of Healthcare Data  
Exchange and Domain-specific  
Distribution of Device Data

*De-Identification?*



## DIAGRAM OF THE CAUSES OF MORTALITY IN THE ARMY IN THE EAST.

2  
APRIL 1855 to MARCH 1856

1  
APRIL 1854 to MARCH 1855

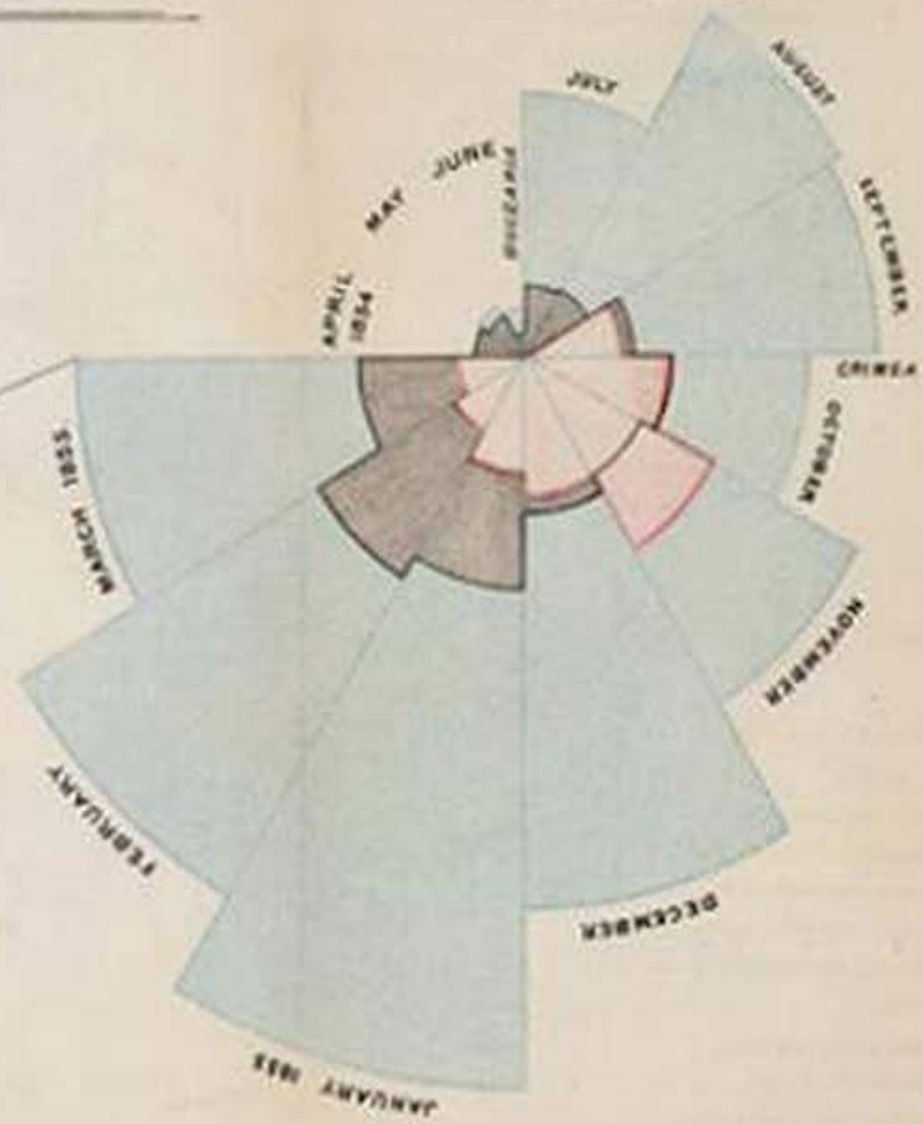
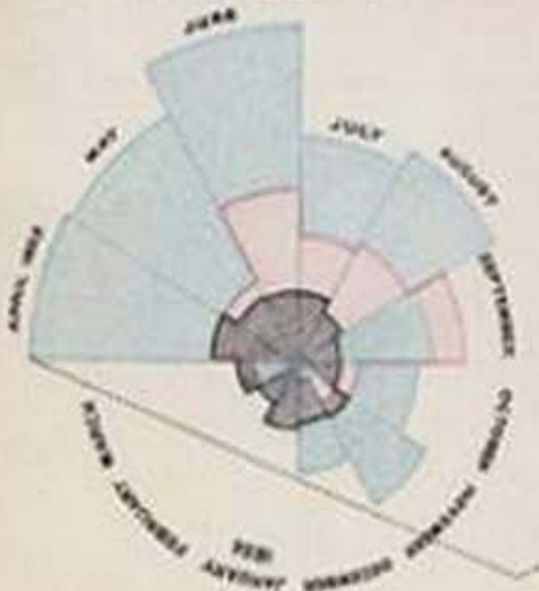

*The areas of the blue, red, & black wedges are each measured from the centre as the common vertex.*

*The blue wedges measured from the centre of the circle represent area for area the deaths from Prussic or Mitegale Zymotic diseases the red wedges measured from the centre the deaths from wounds & the black wedges measured from the centre the deaths from all other causes*

*The black line across the red triangle in Novr 1854 marks the boundary of the deaths from all other causes during the month.*

*In October 1854 & April 1855 the black area coincides with the red, in January & February 1855 the blue coincides with the black.*

*The entire areas may be compared by following the blue, the red & the black lines enclosing them.*

The latest US influenza season is more severe and has caused more deaths than usual.

## EPIDEMIOLOGY

# When Google got flu wrong

*US outbreak foxes a leading web-based method for tracking seasonal flu.*

BY DECLAN BUTLER

When influenza hit early and hard in the United States this year, it quietly claimed an unacknowledged victim: one of the cutting-edge techniques being used to monitor the outbreak. A comparison with traditional surveillance data showed that Google Flu Trends, which estimates prevalence from flu-related Internet searches, had drastically overestimated peak flu levels. The glitch is no more than a temporary setback for a promising strategy, experts say, and Google is sure to refine its algorithms. But as flu-tracking techniques based on mining of web data and on social media proliferate, the episode is a reminder that they will

complement, but not substitute for, traditional epidemiological surveillance networks.

"It is hard to think today that one can provide disease surveillance without existing systems," says Alain-Jacques Valleron, an epidemiologist at the Pierre and Marie Curie University in Paris, and founder of France's Sentinelles monitoring network. "The new systems depend too much on old existing ones to be able to live without them," he adds.

This year's US flu season started around November and seems to have peaked just after Christmas, making it the earliest flu season since 2003. It is also causing more serious illness and deaths than usual, particularly among the elderly, because, just as in 2003, the predominant strain this year is H3N2 — the most

nologies could open the way to easier, faster estimates of ILI, spanning larger populations.

## FEVER PEAKS

A comparison of three different methods of measuring the proportion of the US population with an influenza-like illness.

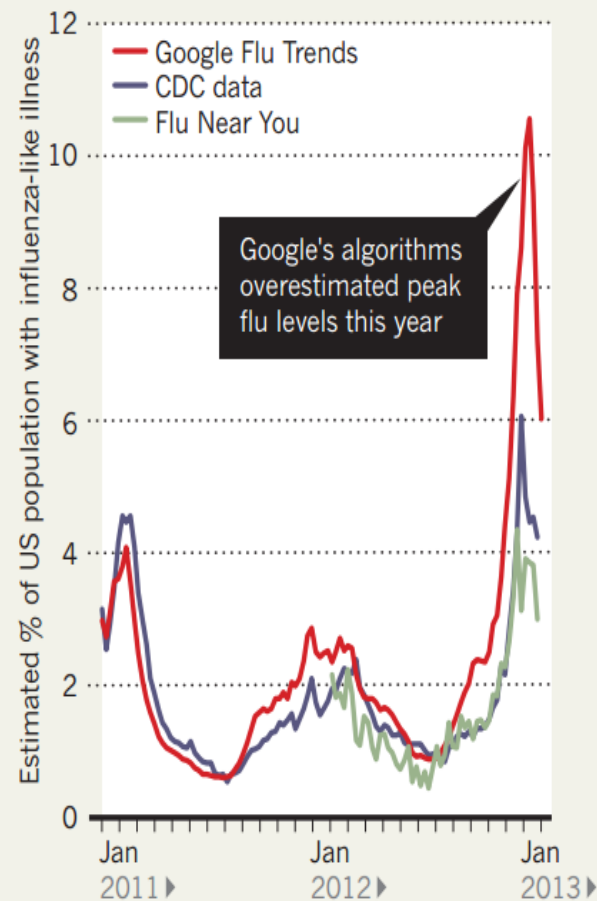

# Perishability of Broad Healthcare Data → Transforming Data into Actionable Information

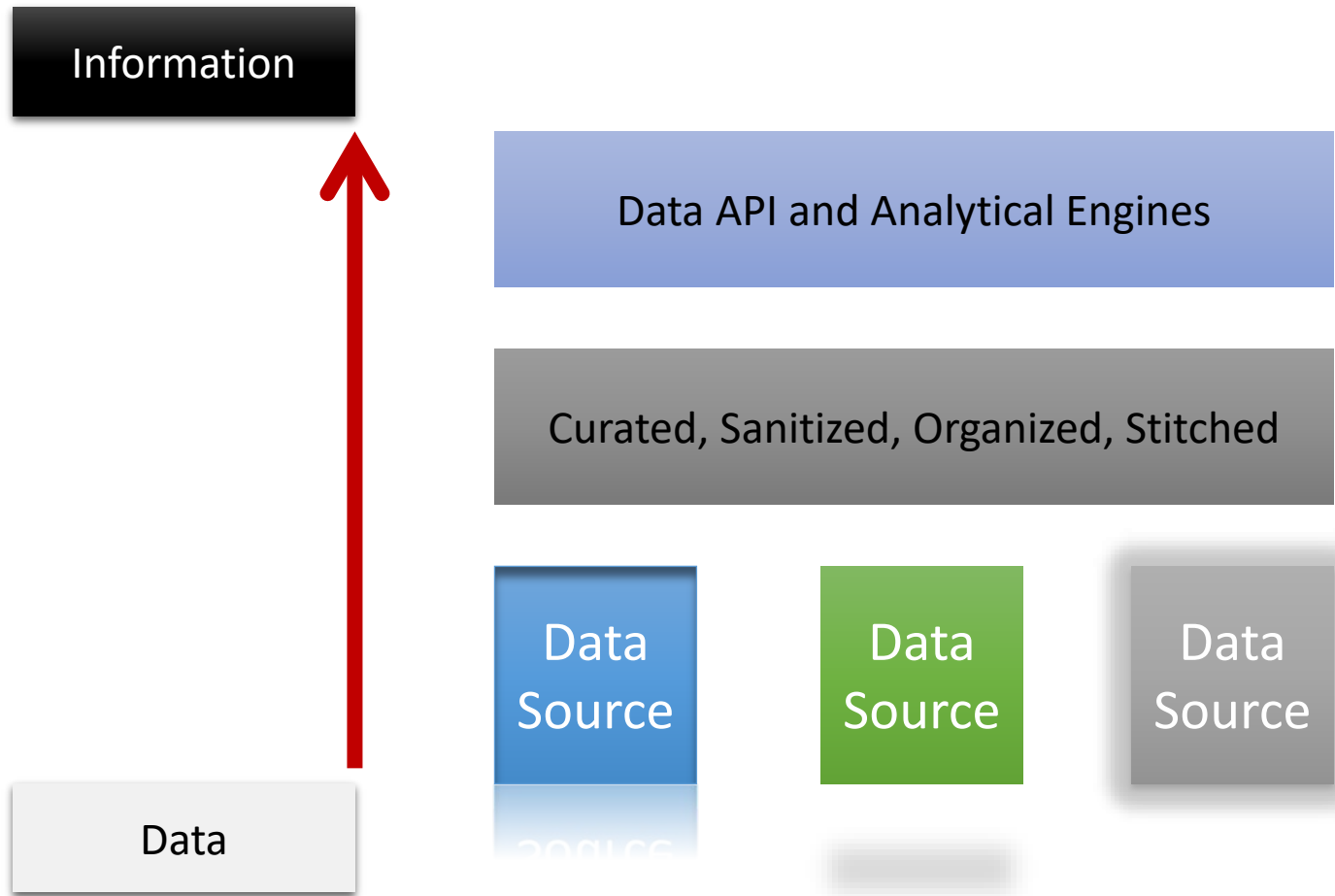

# Healthcare Management - Closed Loop & Quintessentially Patient Specific

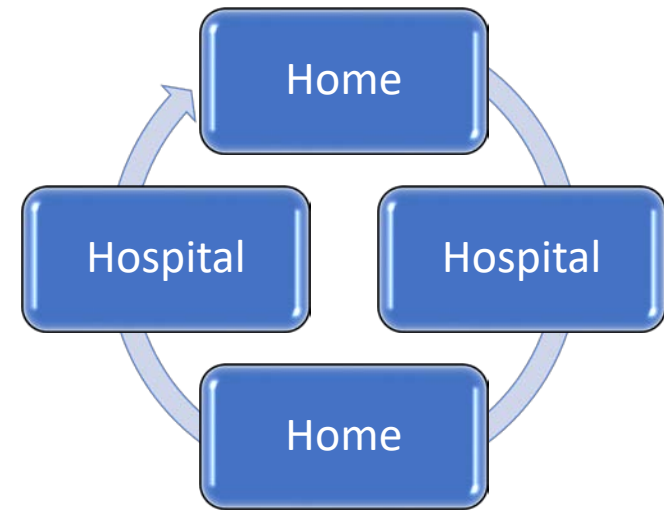
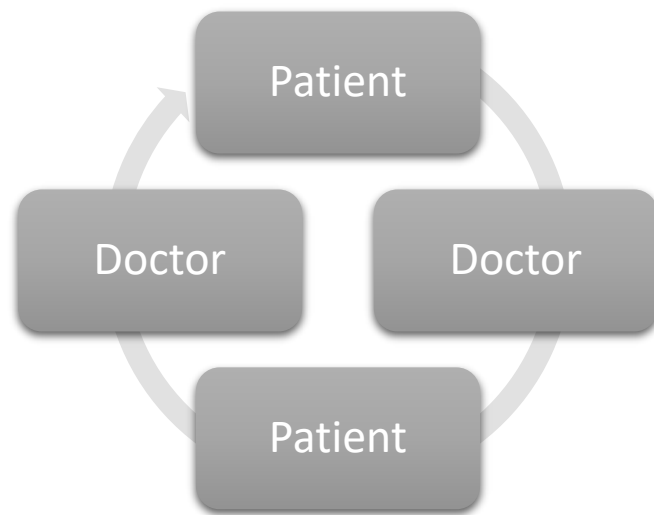

The buzz of “innovation” in healthcare often fails to differentiate between tools and services. Tools and technologies used to deliver healthcare are easy targets for innovation, modularity and scalability. This is innovation in health related tools, ***not healthcare***. Innovation in healthcare is about ***delivery*** of healthcare which is a closed loop management system uniquely focused on one patient (not scalable) and relevant tools must converge at the point of care. The infrastructure (data, transmission, security, privacy) to deliver healthcare may be scalable but innovation to enhance the quality, functionality and reliability of the infrastructure may or may not have an impact on the QoS of healthcare delivery at POC.

# Harry at home with hypercholesterolemia - Larry - Do I need Lipitor today?

DATA ENCRYPTION  
CYBERSECURITY  
Wide Area  
Network

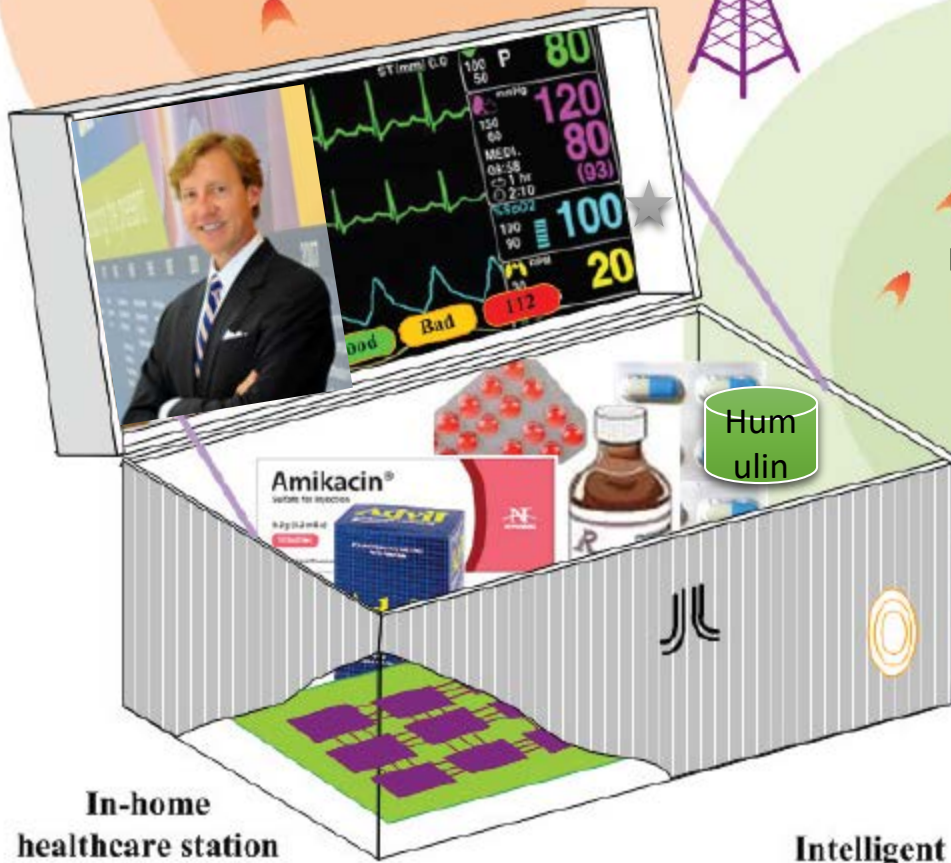

DATA PRIVACY  
Sensor Area  
Network

Intelligent  
pharmaceutical package

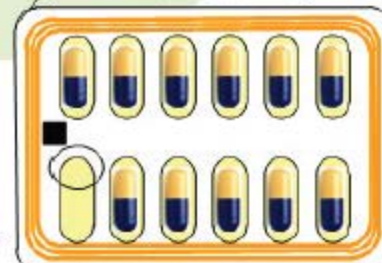

Wearable biomedical  
devices

Dr Jameson: Thanks for avoiding KFC. Your LDL-VLDL ratio looks good. No Lipitor today.

# Closed Loop HealthCare Team: Home to Hospital to Home

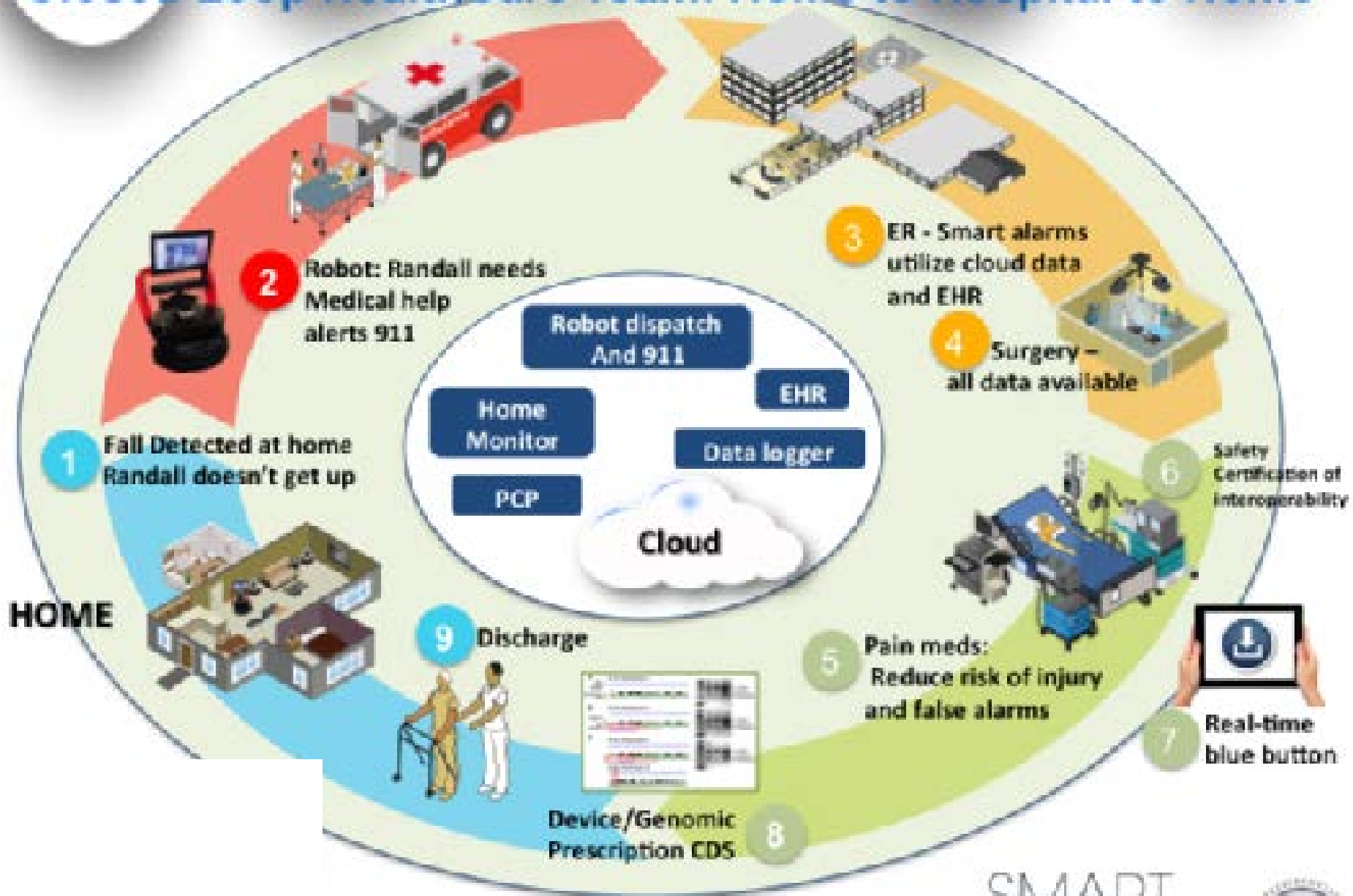

*Are all data created equal?*

**DON'T USE MY DATA**



"Before I write my name on the board, I'll need to know how you're planning to use that data."



# Principle of Differential Curation and De-identification of Data

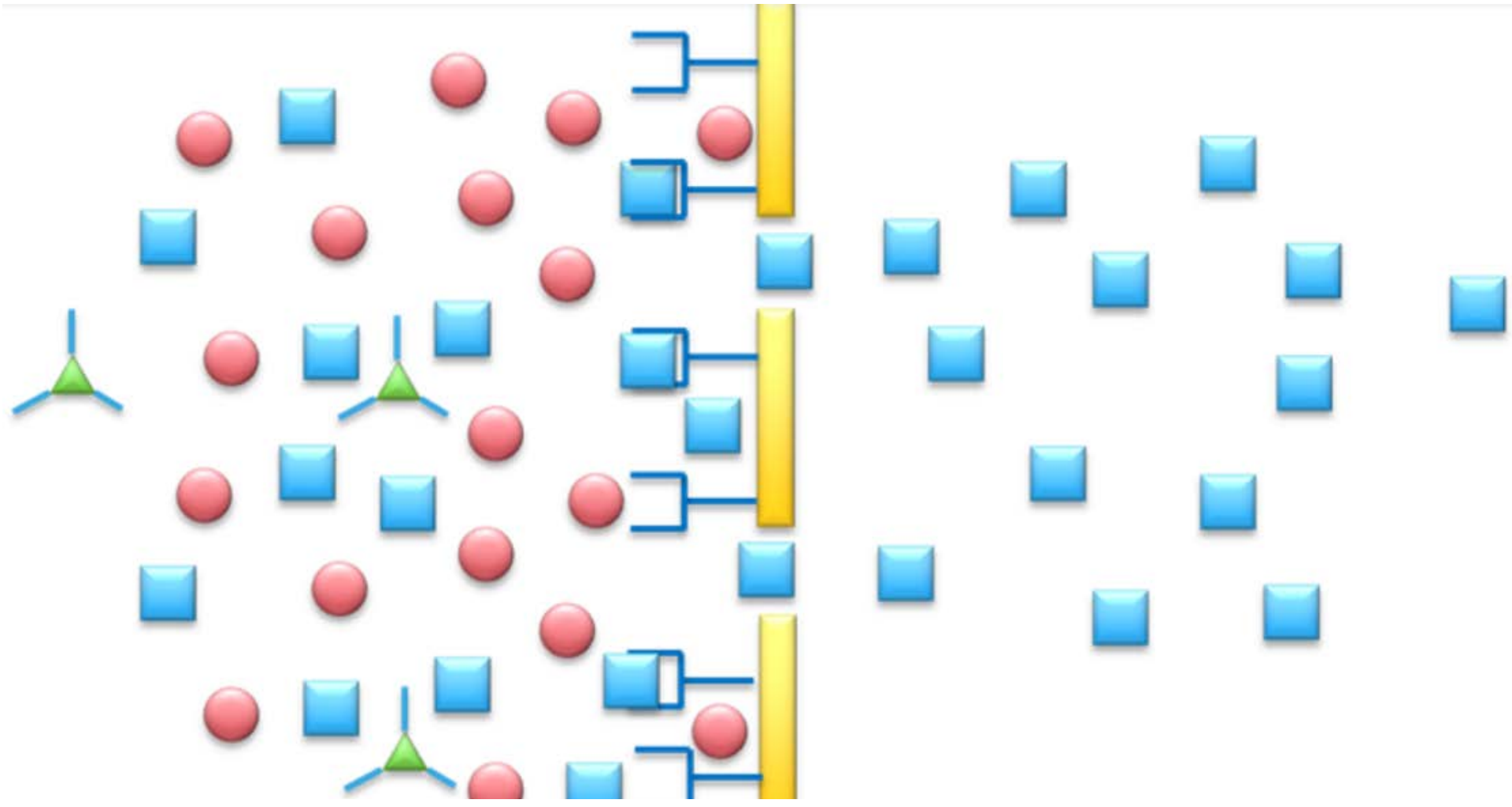

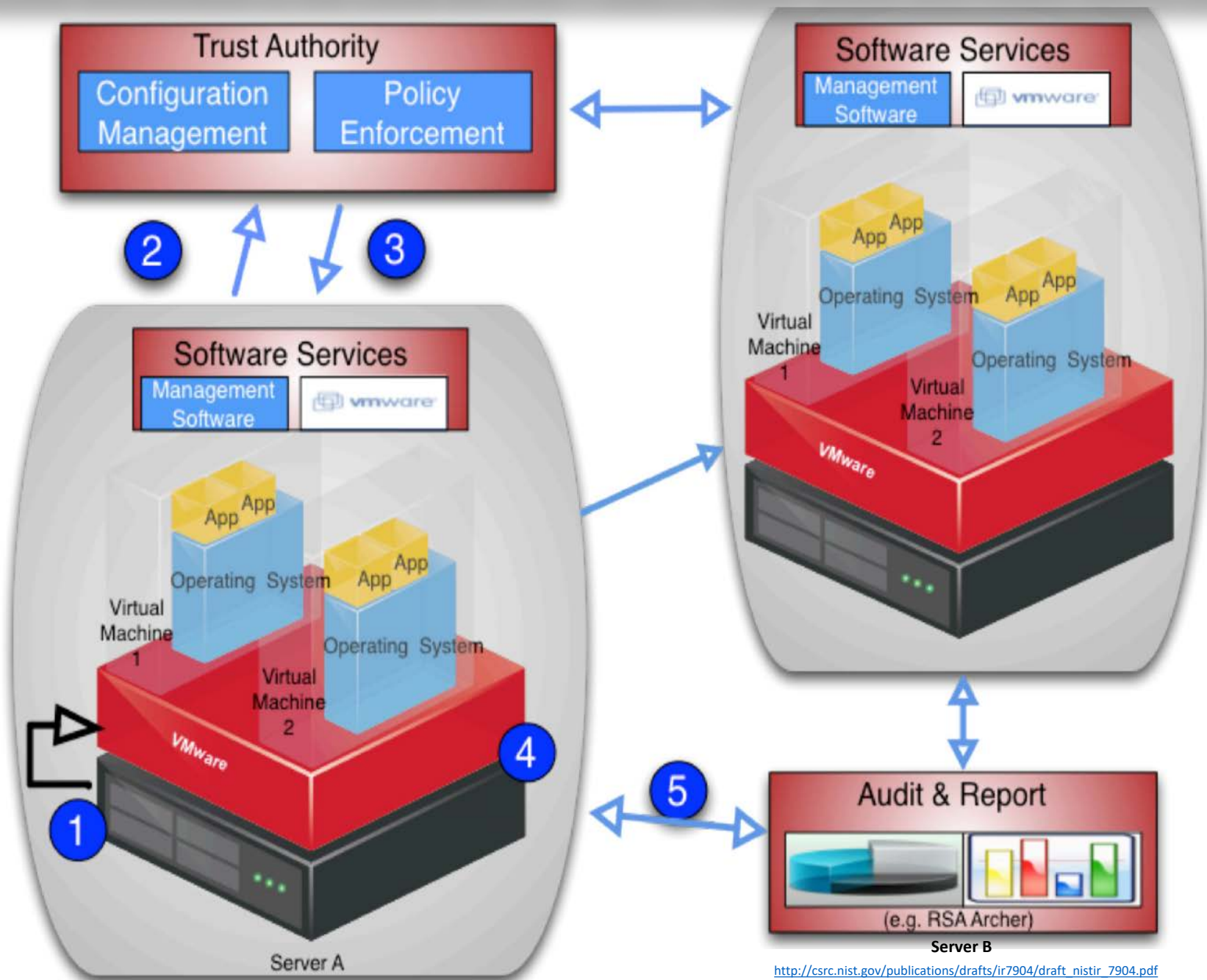

**ICE**  
**Integrated**  
**Clinical**  
**Environment**  
**HEALTH DATA**

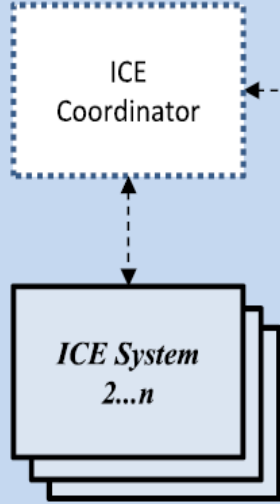
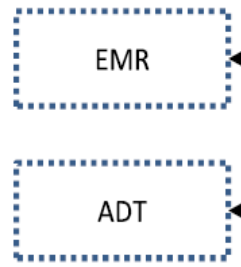

*ICE System Scope*

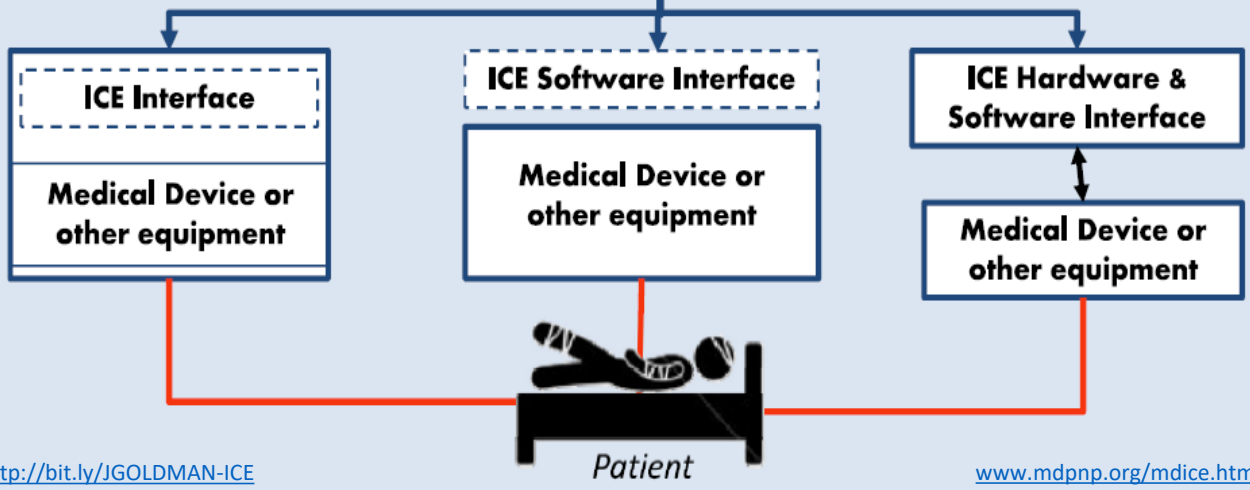
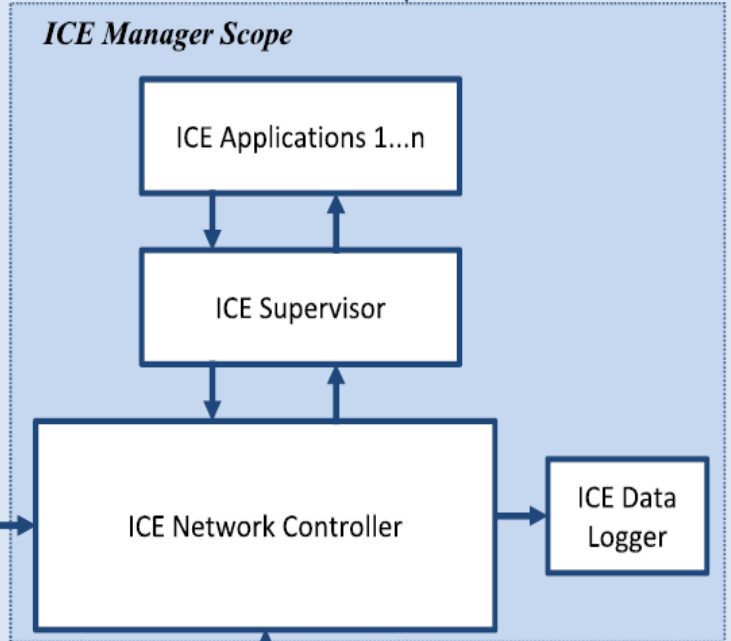

Why ICE standards are critical –  
 Device Agnostic Data Integration  
 Global Interoperability Platform

# De-identified Data (DID) will drive Research – Management Science – Policy – Funding

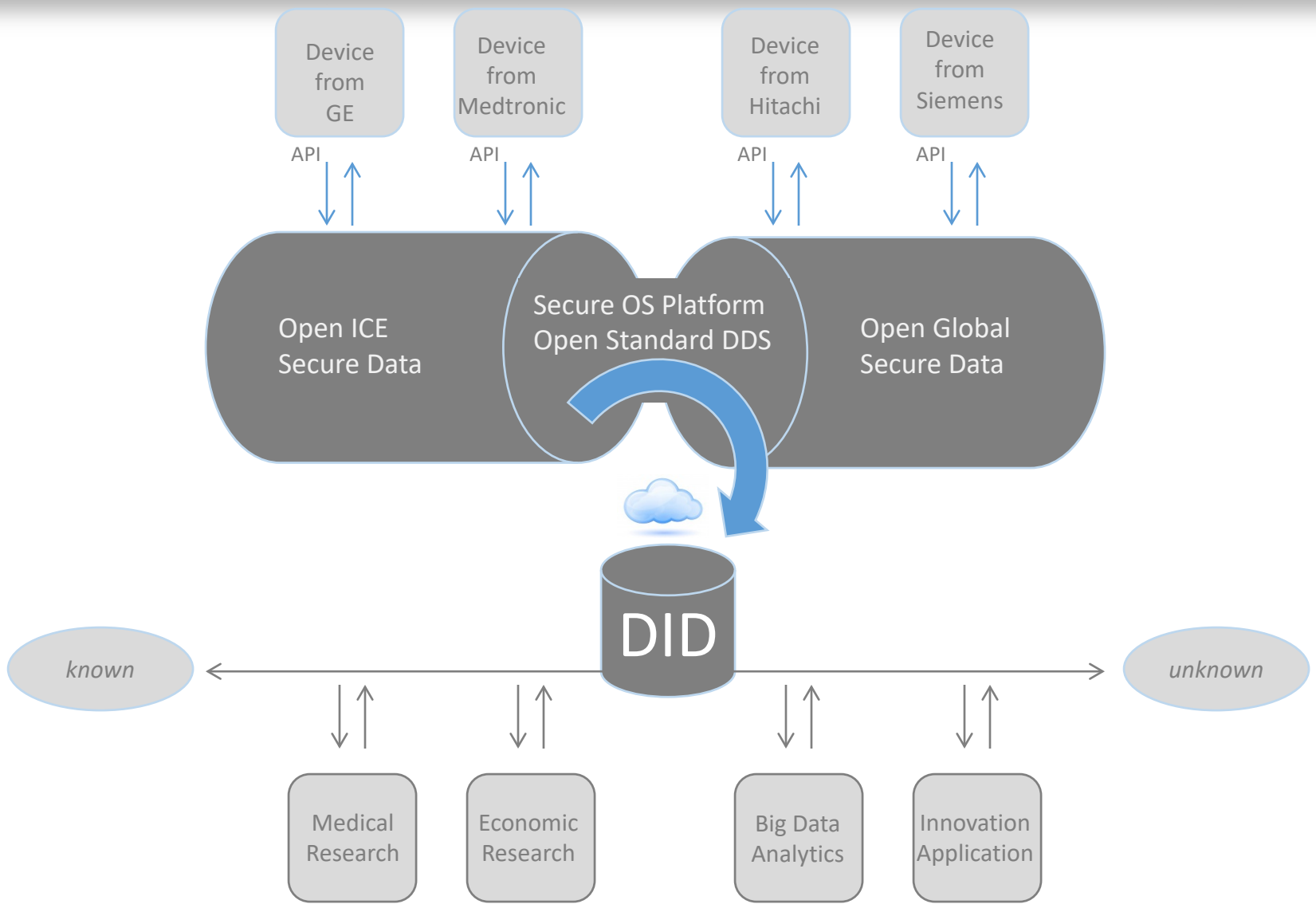

*Note: In certain instances, CPS related time constraints may render traditional cloud based D2D architecture unacceptable [QoS] due to latency.*

# Data Dissociation using meta data to identify/label data type

Clinic VIEW

Name	SSN-UID	Street Address	Zip Code	Blood Glucose	Weight in kg
Jane Does Tag N1	123-45-6789 Tag S1	77 Mass Ave Tag A1	02139 Tag Z1	190 mg/dl Tag G1	190 Tag K1
John Does-Not Tag N2	123-45-6790 Tag S2	86 Brattle St Tag A2	02138 Tag Z2	109 mg/dl Tag G2	159 Tag K2

DID VIEW

Name	SSN-UID	Street Address	Zip Code	Blood Glucose	Weight in kg
			02139 Tag Z1	190 mg/dl Tag G1	190 Tag K1
			02138 Tag Z2	109 mg/dl Tag G2	159 Tag K2

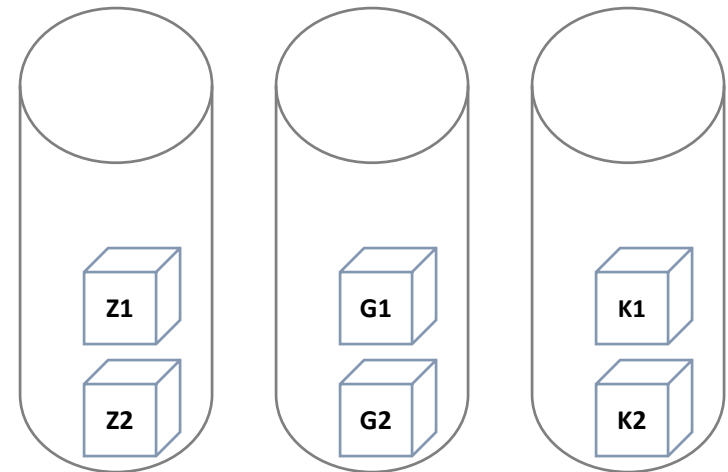

Data Re-association using De-Identified Data (DID) Stack

Same data but ask a different

**QUESTION**

# Same Data ← Different Questions → Extracting Information from DID

Epidemiologists

Economists

Physician

*What is the distribution of potential diabetics by zip code?*

*Is there a relationship between per capita income and body fat?*

*Can we correlate high blood glucose with increased body weight?*

Name	SSN-UID	Street Address	Zip Code	Blood Glucose	Weight in kg
			02139 Tag Z1	190 mg/dl Tag G1	190 Tag K1
			02138 Tag Z2	109 mg/dl Tag G2	159 Tag K2

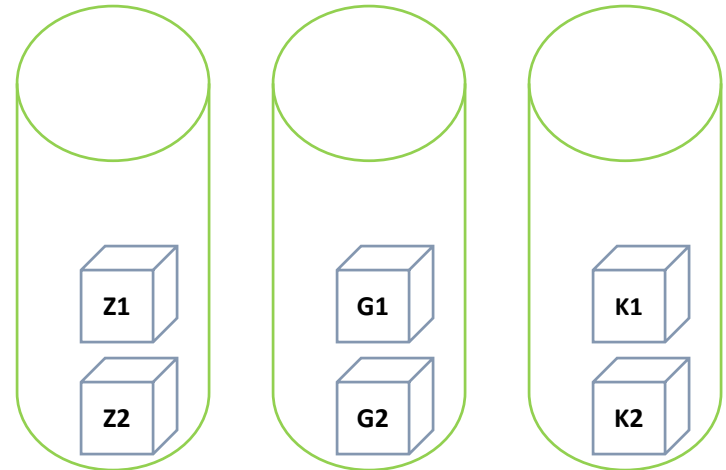

# Secured Data <> Re-association of De-Identified Data (DID)

Re-sequence DID → HADOOP-esque concept ?

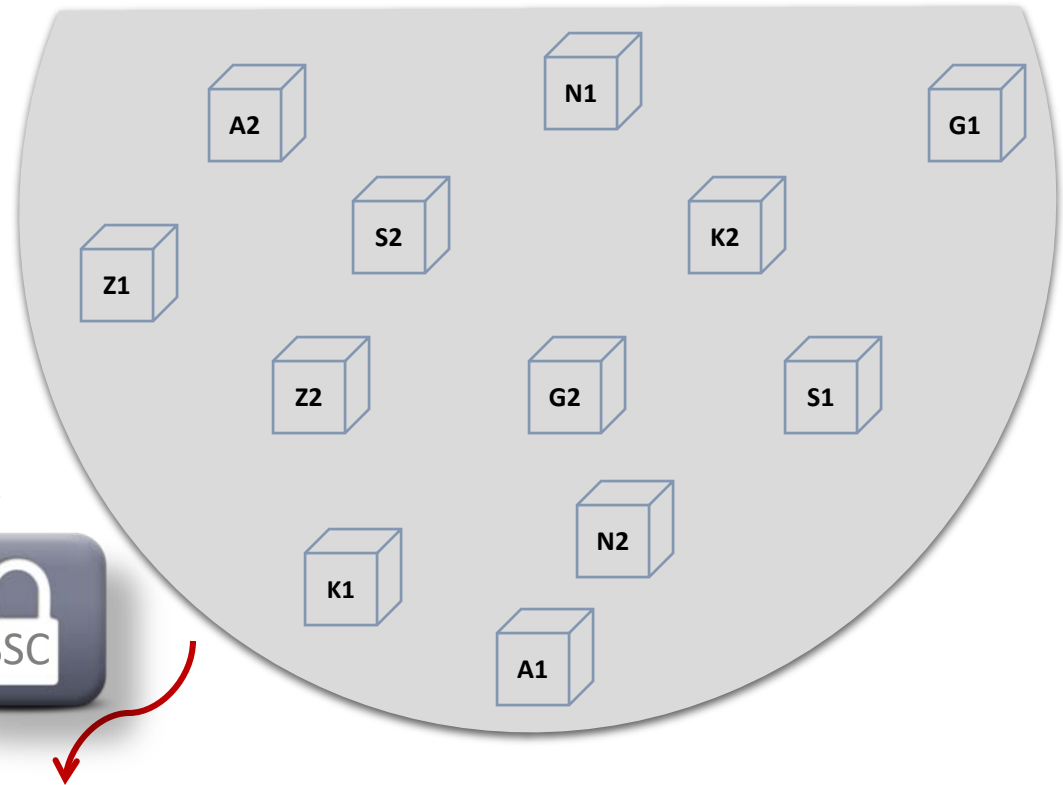
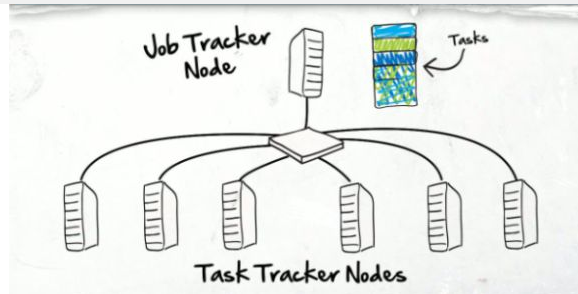

Name	SSN-UID	Street Address	Zip Code	Blood Glucose	Weight in kg
Jane Does Tag N1	123-45-6789 Tag S1	77 Mass Ave Tag A1	02139 Tag Z1	190 mg/dl Tag G1	190 Tag K1
John Does-Not Tag N2	123-45-6790 Tag S2	86 Brattle St Tag A2	02138 Tag Z2	109 mg/dl Tag G2	159 Tag K2

*This is a suggestion by the author. Not a proven concept in practice.*

Re-stitch De-Identified Data - create Secure Sequencing Code (SSC)



# Do we need novel approaches and innovation in curation in order to extract information from data?

- Data may be doubling approximately every 18-20 months or every 12-18 months
- Number of internet-connected devices may have exceeded 10 billion
- Payments by mobile phone alone are hurtling toward \$1 trillion
- We may be generating  $2.5 \times 10^{18}$  (exabytes) of data each day
- Stored information in the world ~ 1200 exabytes
- Printed on CD-ROMs & stacked up, it will stretch to the Moon in 5 separate piles
- In 3<sup>rd</sup> century BC, Library of Alexandria represented most knowledge in the world
- Digital deluge offers each person on Earth 320 times as much information as above

# Could a Neuroscientist Understand a Microprocessor?

**Eric Jonas<sup>1\*</sup>, Konrad Paul Kording<sup>2,3</sup>**

**1** Department of Electrical Engineering and Computer Science, University of California, Berkeley, Berkeley, California, United States of America, **2** Department of Physical Medicine and Rehabilitation, Northwestern University and Rehabilitation Institute of Chicago, Chicago, Illinois, United States of America, **3** Department of Physiology, Northwestern University, Chicago, Illinois, United States of America

\* [jonas@eecs.berkeley.edu](mailto:jonas@eecs.berkeley.edu)

*Value from data and analytics to generate information*

## Think and Connect like a Neuron?

Can detection of device data (low oxygen saturation) trigger in-network intelligence, medical alert & action?



*Application Aware Networking - an old concept renewed by connectivity*

# Santiago Ramón y Cajal



Slice of neo-cortex, as identified by Cajal. Every cubic mm contains about 100,000 neurons and 2-4 km of axons and dendrites. Layers I-VII on the right = 2mm vertical distance.

Born	1 May 1852 <a href="#">Petilla de Aragón</a> , <a href="#">Navarre</a> , <a href="#">Spain</a>
Died	18 October 1934 (aged 82) <a href="#">Madrid</a> , <a href="#">Spain</a>

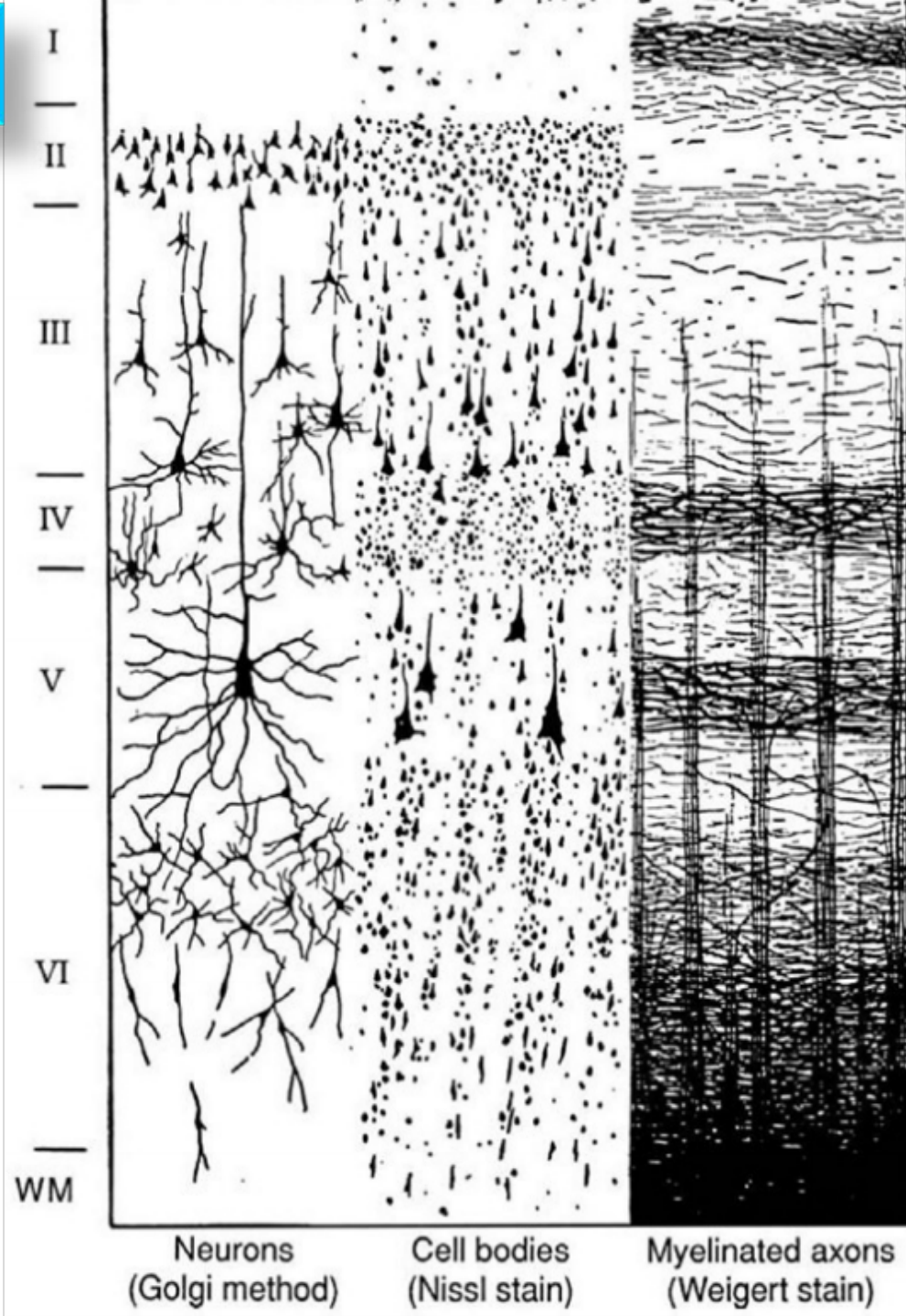

Host Layers

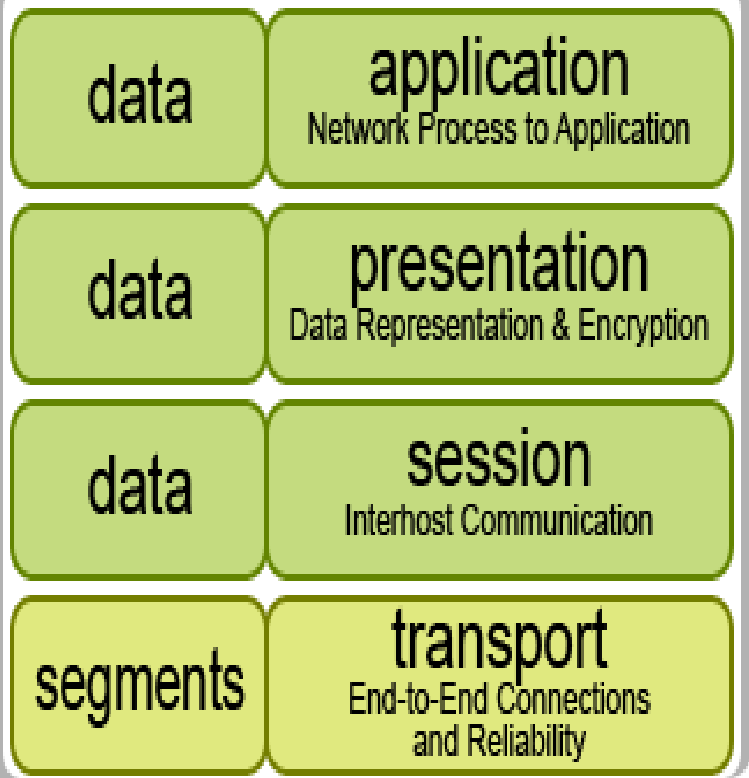

Media Layers

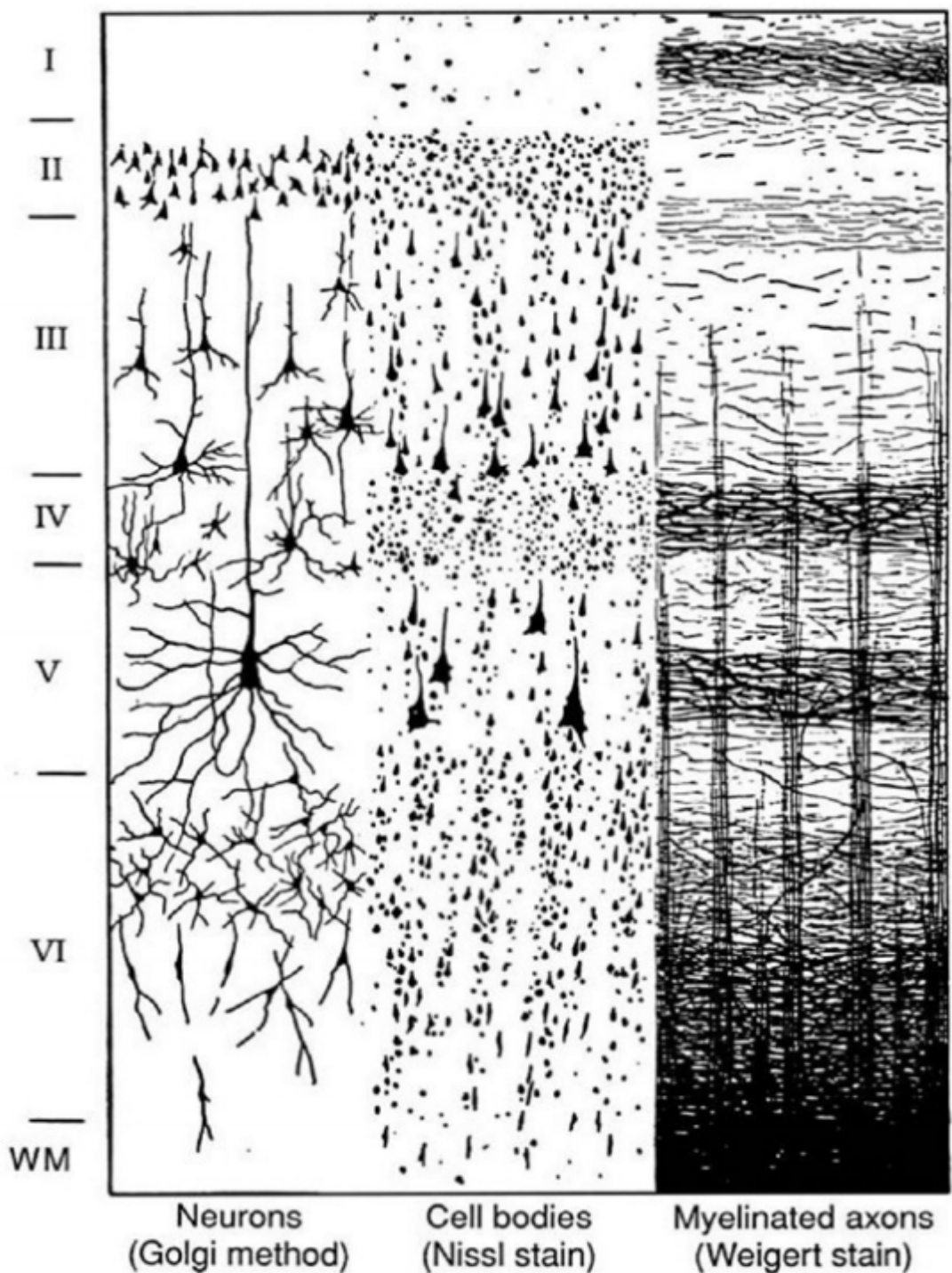
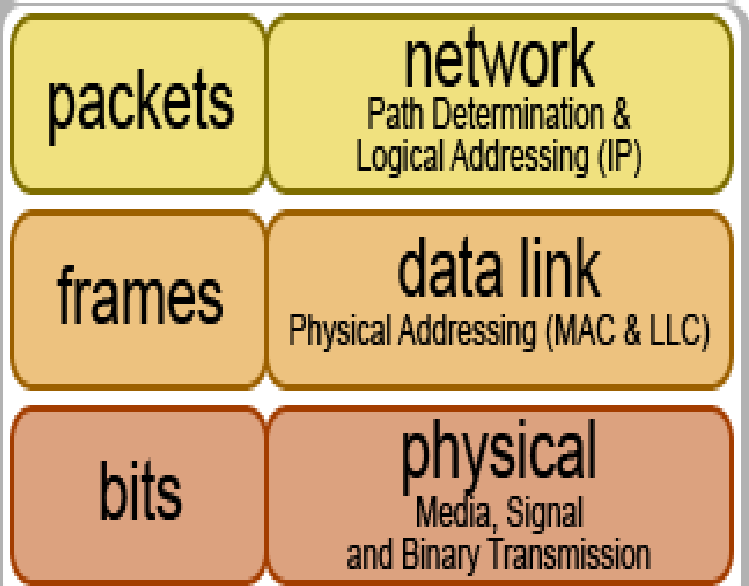

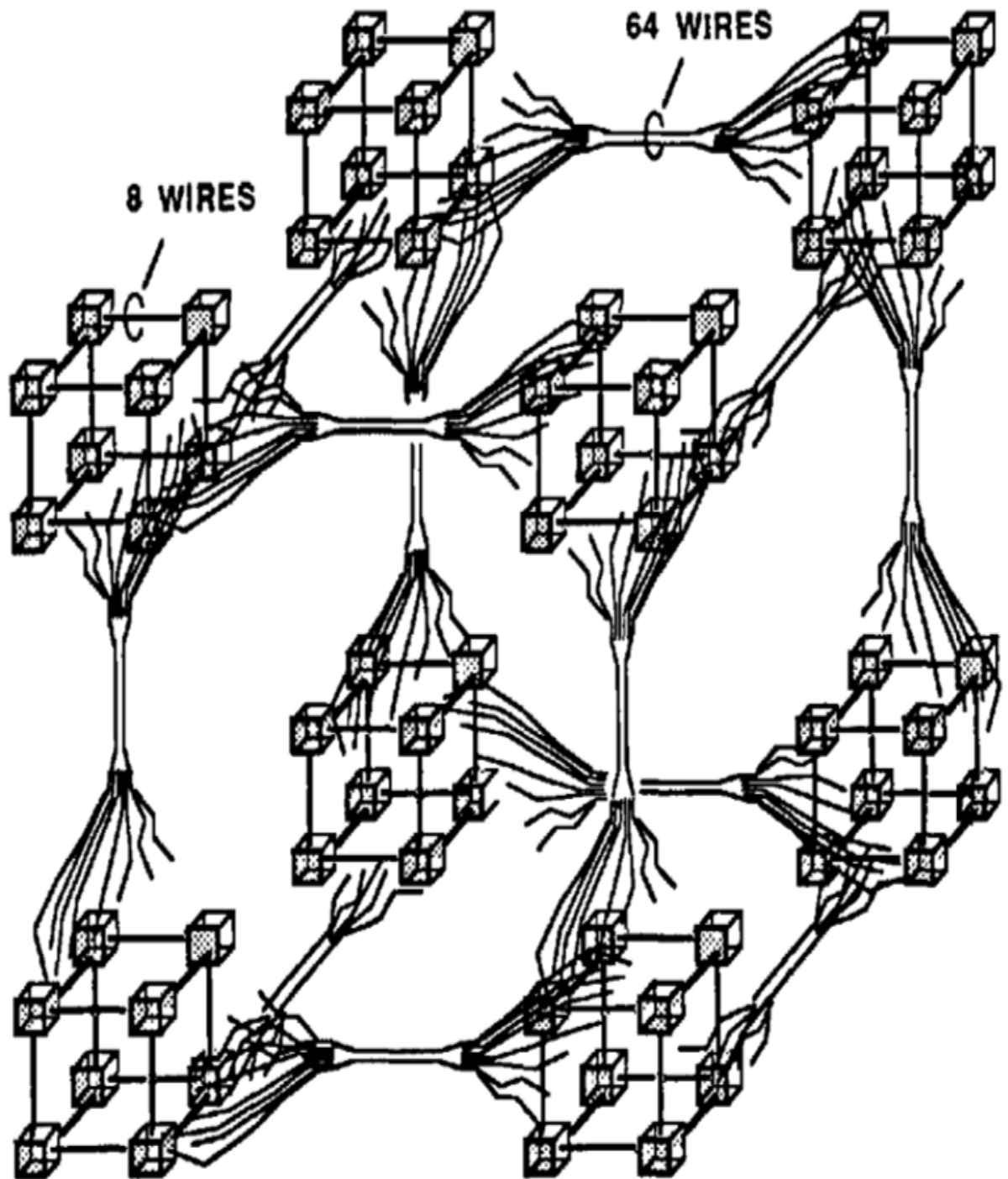

*Here, 8 agents make a little cube, and 8 such cubes make a 64-agent supercube.*

*If we join 8 of these supercubes, we'll have 512 agents. And if we repeat this cube-on-cube pattern ten times, the resulting supercube will contain a billion agents!*

*But if we link each agent to 30 others instead of only 6, then each agent could communicate with a billion others in only 6 steps.*

# Hierarchical Temporal Memory (HTM), a form of ANN, may be useful for time criticality of time series data

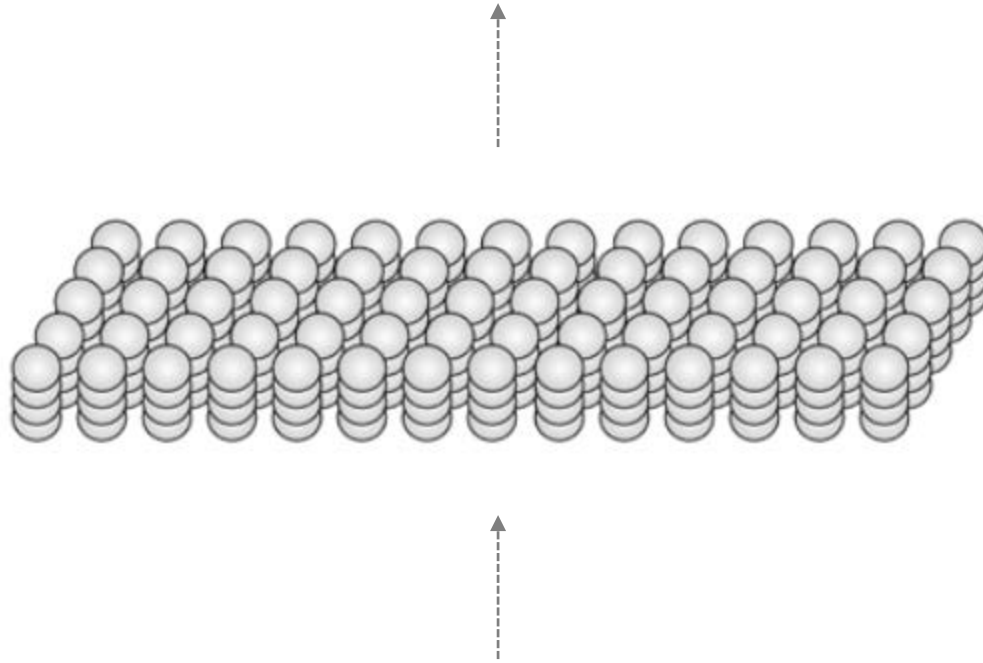

Section of a HTM region, equivalent to 1 layer of neurons in the neocortical region (layer 3). Each 4-cell column connects to a subset of the input and each cell connects to other cells in the region (connections are not shown). The principle of this connectivity was abstracted in Minsky's cube-on-cube.

# HTM (CLA) attributes include time and context – essential for many time sensitive healthcare applications and data analytics (context)

Hierarchical Temporal Memory (HTM) is a machine learning tool to capture the structural and algorithmic properties of the neocortex which is the seat of intelligent thought in the mammalian brain. High level vision, hearing, touch, movement, language and planning are performed by the neocortex. Given such a diverse suite of cognitive functions, the neocortex may be expected to implement an equally diverse suite of specialized neural algorithms. In reality, the neocortex displays a remarkably uniform pattern of neural circuitry. In other words, the neocortex implements a common set of algorithms to perform many different intelligence functions. It may be analogous to an abstraction which is used in a systemic context.

Programming HTM cortical learning algorithms require training through exposure to a stream of sensory data (capabilities are determined largely by exposure). HTM is a memory based ANN system. HTM networks are trained on time varying data and rely on storing a large set of patterns and sequences. A crucial distinction of HTM is embedded in the semantics of time which is an important element in applications relating to cyberphysical systems (CPS). Classic computer memory has a flat organization and does not have an inherent notion of time because the semantics of time are not available in the ISA (instruction set architecture). Therefore, in the classical programming environment, we can implement any kind of data organization and structure on top of the flat computer memory and control how and where information is stored.

HTM memory is more restrictive. HTM memory has a hierarchical organization and is inherently time based. Information is always stored in a distributed fashion. HTM user is expected to specify the size of the hierarchy and what to train the system on but the HTM controls where and how information is stored (data, patterns, text, sequences). Hence, HTMs are learning and prediction machines that can be applied to many types of problems through the inherent abstractions in the system. Although an HTM region is equivalent to only one portion of a neocortical region (layer 3), it can perform inference and prediction on complex data streams. Hence the significance of HTMs in data analytics in multiple domains or verticals.

Although neurons in the neocortex are highly interconnected, inhibitory neurons guarantee that only a small percentage of the neurons are active at one time. Thus, information in the brain is always represented by a small percentage of active neurons within a large population of neurons. This kind of encoding is called a “sparse distributed representation” where a small percentage of neurons are active at one time. “Distributed” refers to the characteristic that the activation of many neurons are required in order to represent something. A single active neuron conveys some meaning but it must be interpreted within the context of a population of neurons to convey the full or complete meaning relevant to the context.



# The Final Frontier?

## **Precision Medicine**

# Non-Small Cell Lung Carcinoma

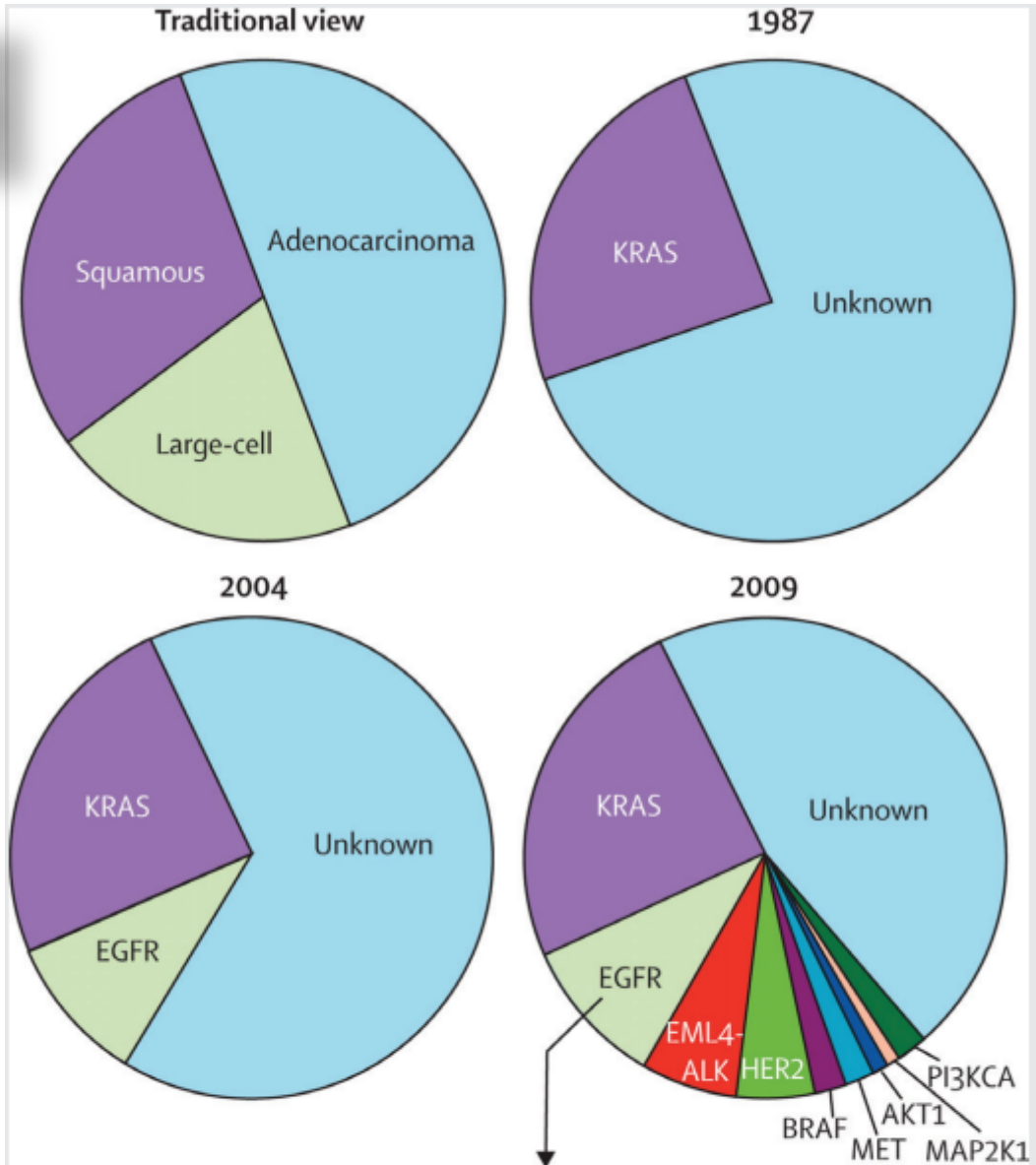

- **Mutations associated with drug sensitivity**  
EGFR Gly719X, exon 19 deletion, Leu858Arg, Leu861Gln
- **Mutations associated with primary drug resistance**  
EGFR exon 20 insertions
- **Mutations associated with acquired drug resistance**  
EGFR Thr790Met, Asp761Tyr, Leu747Ser, Thr854Ala

# Imprecision Medicine

new ones and identifying appropriate disease biomarkers, such as tumour DNA circulating in the bloodstream. It will also require a cultural shift on many levels — in regulatory agencies, in pharmaceutical companies and, most of all, in the clinic.

## A WORLD OF DIFFERENCE

Discovering that an intervention works well in certain groups happens relatively rarely and often by chance. Researchers typically get disappointing results with a drug in large, population-based trials. This leads them to conduct ad hoc post-trial analyses, to try to identify the factors that cause some of the people in the trial to seem to be responsive<sup>3</sup>.

For instance, the drug Gleevec (imatinib) was found to double survival rates of leukaemia patients<sup>4</sup> with a chromosomal abnormality in their tumours called the Philadelphia translocation. Similarly, it turns out that Erbitux (cetuximab) improves the survival of people with colorectal cancer whose tumour cells carry a mutated *EGFR* gene but not a mutated *KRAS* gene<sup>5</sup>.

This approach to discovery is inefficient at best. Conventional phase III trials involve thousands of people. The intervention being tested is often given at random to one group while another group receives a sham treatment, such as a sugar pill or the standard treatment that physicians would give such patients. Because scant data are collected on factors such as genetics, lifestyles and diets, the results of these trials often indicate the need for yet another study to validate the effectiveness of the intervention among the apparent responders and to establish the

**1. ABILIFY (aripiprazole)**  
Schizophrenia



**2. NEXIUM (esomeprazole)**  
Heartburn



**3. HUMIRA (adalimumab)**  
Arthritis



**4. CRESTOR (rosuvastatin)**  
High cholesterol



**5. CYMBALTA (duloxetine)**  
Depression



**6. ADVAIR DISKUS (fluticasone propionate)**  
Asthma



**7. ENBREL (etanercept)**  
Psoriasis



**8. REMICADE (infliximab)**  
Crohn's disease



**9. COPAXONE (glatiramer acetate)**  
Multiple sclerosis



**10. NEULASTA (pegfilgrastim)**  
Neutropenia



# Precision Medicine – Drug Development

A successful example of the precision medicine approach to drug development involves the drug Crizotinib, an inhibitor of the MET and ALK kinases, which began clinical development in a broad population of patients with lung cancer (Kwak et al. 2010). During the early stages of the initial Crizotinib clinical trial conducted by pharmaceutical industry scientists, an independent group of academic scientists published their discovery that a particular chromosomal translocation involving the gene encoding ALK drives tumor growth in a subset of non-small cell lung cancer patients (Soda et al. 2007). Access to this knowledge allowed the pharmaceutical industry scientists to modify their clinical trial to look specifically at a cohort of patients with this translocation, and the results were dramatic. For those patients who had the translocation, the median disease-free survival with Crizotinib was a year, compared to just a few months with the standard of care. Thus, even in a trial that involved only a small number of patients that were compared to historical controls, it was obvious that the drug was active. In contrast, in an unselected patient population, most patients did not benefit from this drug and it was unclear whether the drug had any activity.

(Crizotinib is expected to receive regulatory approval for treatment of ALK translocation-positive lung cancer within the next year.)

Tuesday, April 21, 2015 - 10:00am EDT

Pfizer Inc. announced today that XALKORI® (crizotinib) received Breakthrough Therapy designation by the U.S. Food and Drug Administration (FDA) for the potential treatment of patients with ROS1-positive non-small cell lung cancer (NSCLC). Occurring in approximately one percent of NSCLC cases<sup>1</sup>, ROS1-positive NSCLC represents a particular molecular subgroup of NSCLC.<sup>2</sup> XALKORI currently is approved in the U.S. for the treatment of patients with metastatic NSCLC whose tumors are anaplastic lymphoma kinase (ALK)-positive as detected by an FDA-approved test.

# The principle of GIS helped to organize patient-centric information layers

## Google Maps: GIS layers

Organized by Geographical Positioning

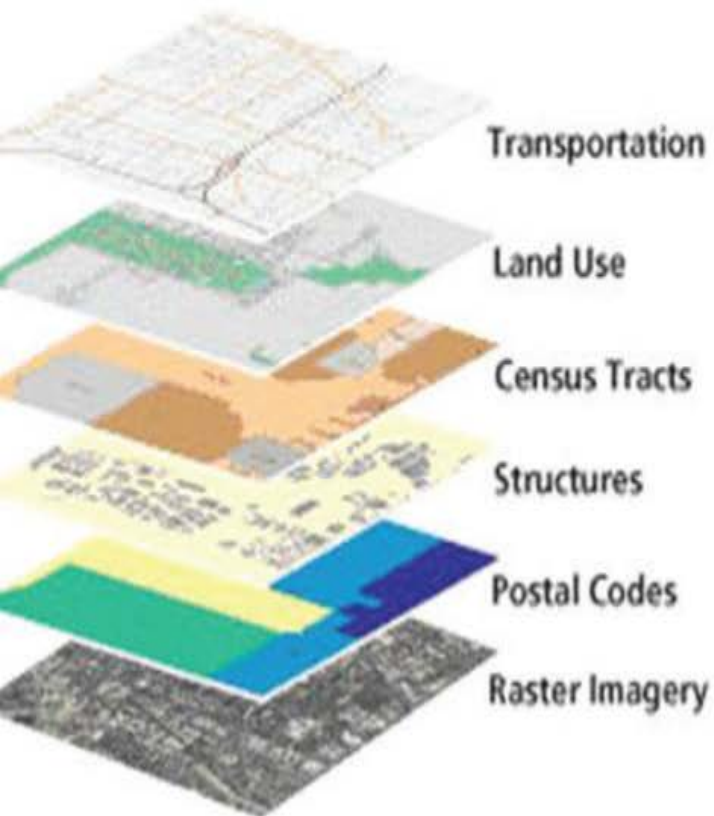

## Information Commons

Organized Around Individual Patients

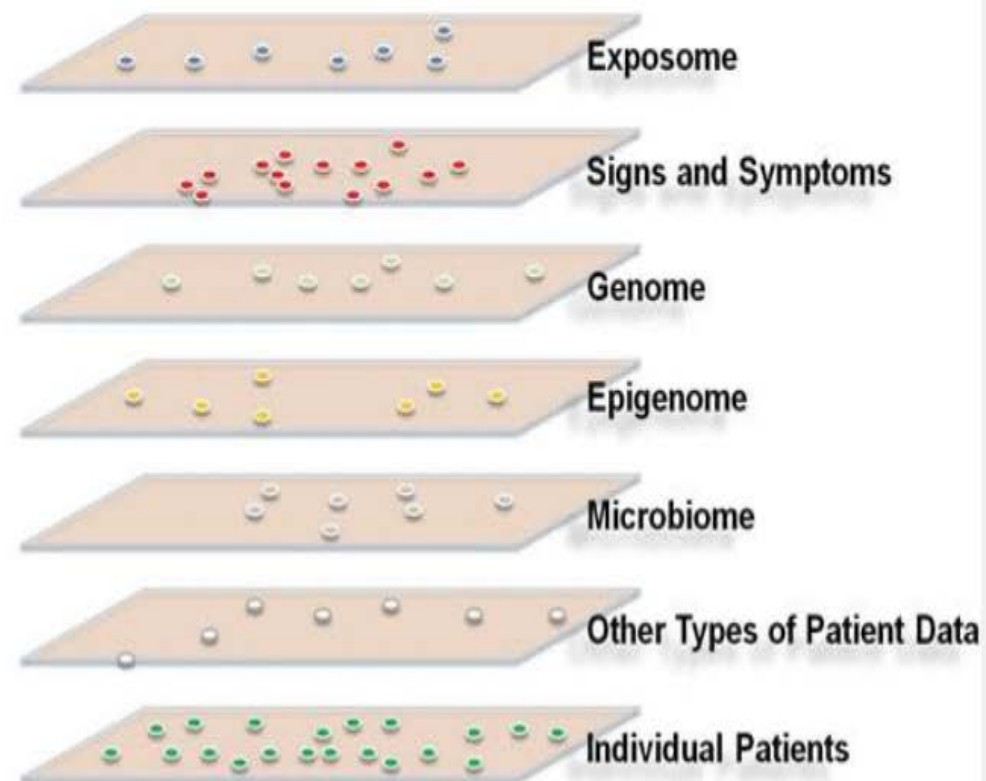

# Data, Devices and Connected Information (IoT)

## Factors Influencing Future Precision Medicine

Bio-medical Knowledge Network

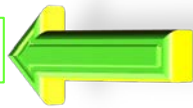

Information Commons  
Organized Around Individual Patients

*External Exposure: Where are you? GPS*



Exposome

*Constant wearables: temp, bp, rr, hr, oximetry*



Signs and Symptoms



Genome



Epigenome



Microbiome

*Food, hours of sleep, frequency of urination*



Other Types of Patient Data

*Blood glucose, cholesterol, urea, hemoglobin*



Individual Patients

# The Foundations of Genomic Medicine

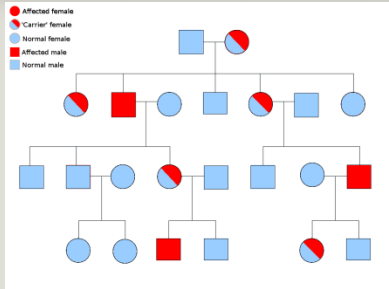

**Genome**

Transcriptome

Proteome

Metabolome

Microbiome

Epigenome

Exposome

Social graph

**Biosensors**

Imaging



Glucose  
NanoSensor  
NanoRadio



# Human Genomics in an Age of Precision Medicine

## Designer Drugs Delivered by Drones in the Wireless Hospital

*Irrational exuberance ?*

### Individualized genomic medicine From prewomb to tomb

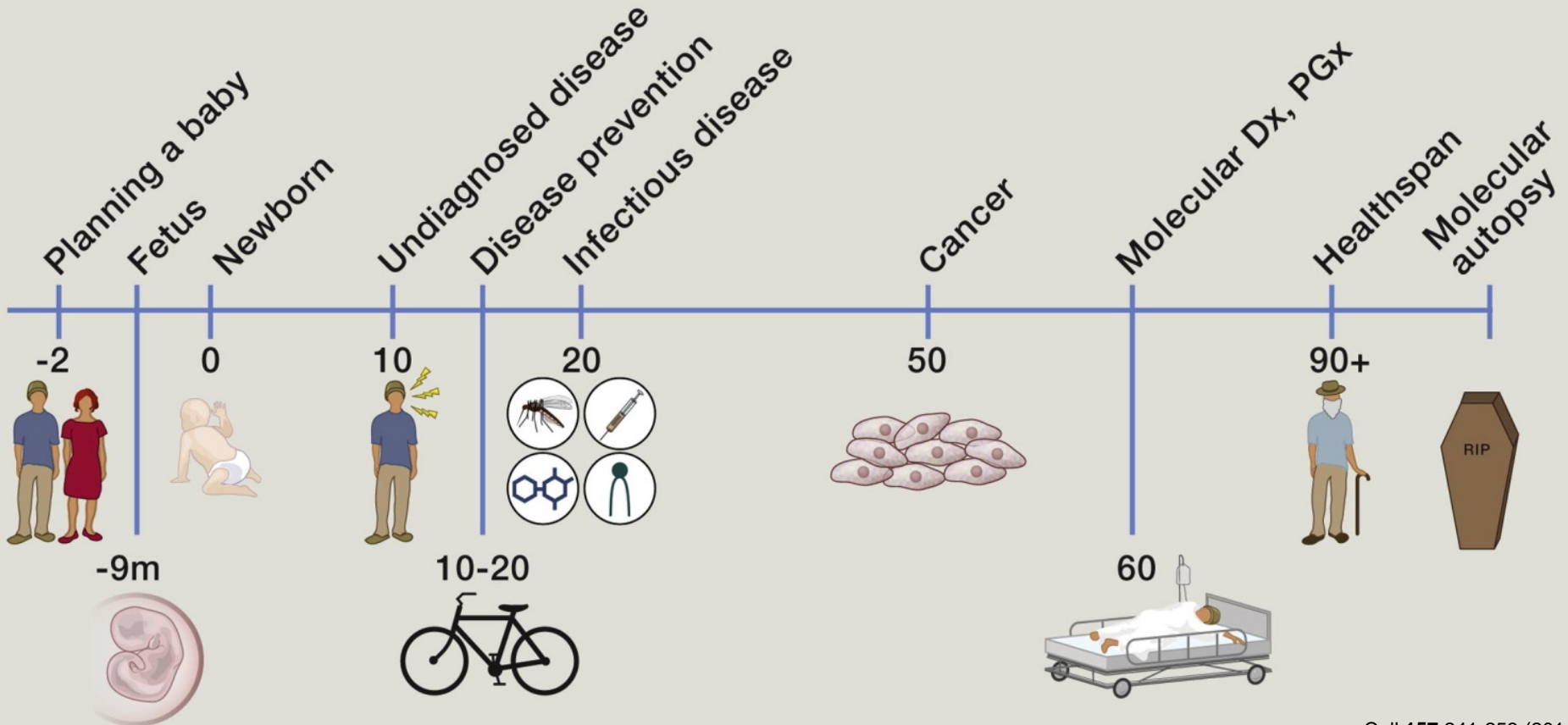

# What may make precision medicine feasible – the rapid advances in automation and the plummeting cost of complete genome sequencing

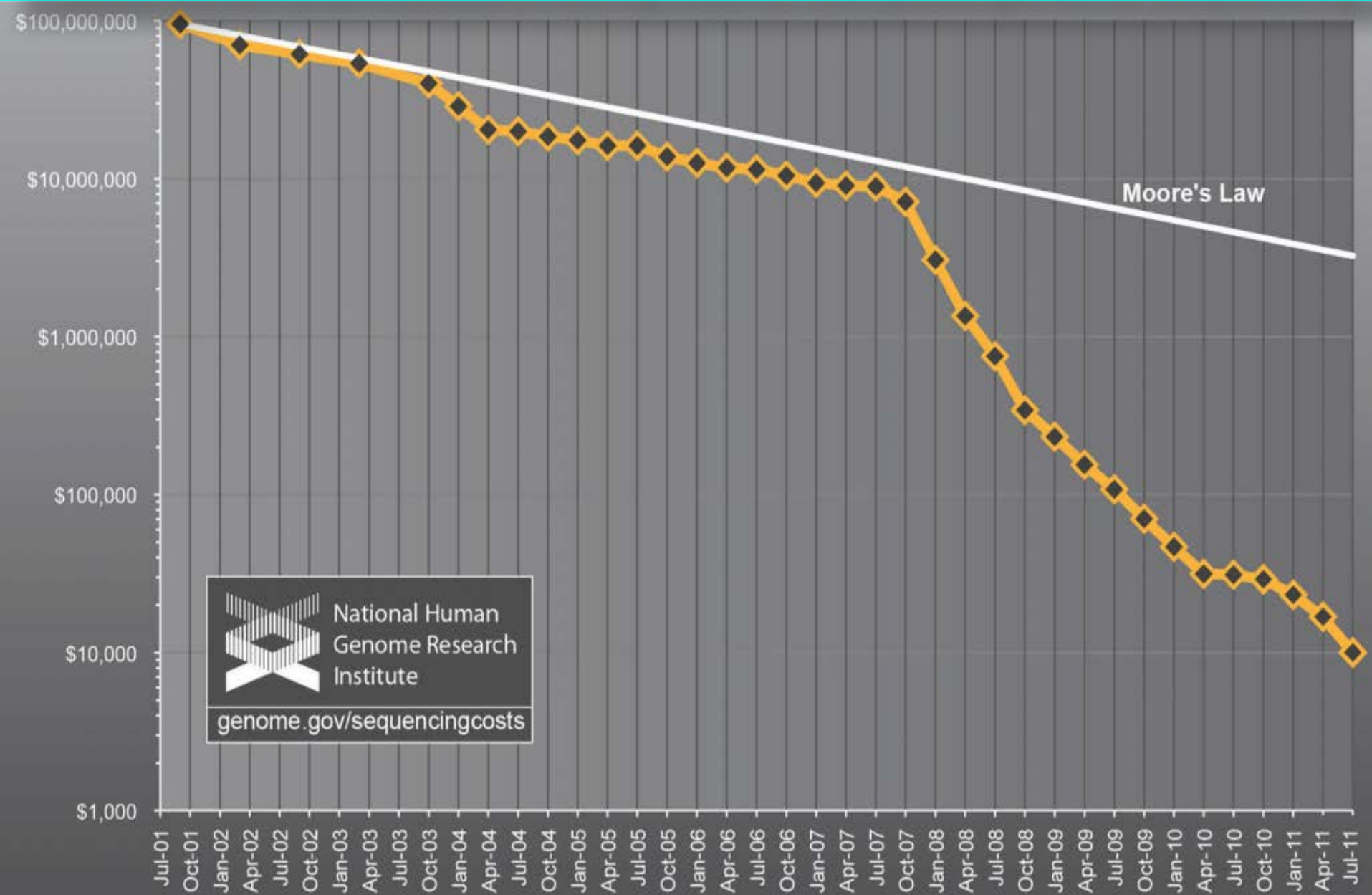

# MinION USB stick gene sequencer finally comes to market

By John Hewitt (<http://www.extremetech.com/author/jhewitt>) on September 19, 2014 at 2:10 pm



What is the challenge of  
precision medicine?

*Integration*

*How do we integrate data and information from these systems with diverse open source healthcare platforms?*

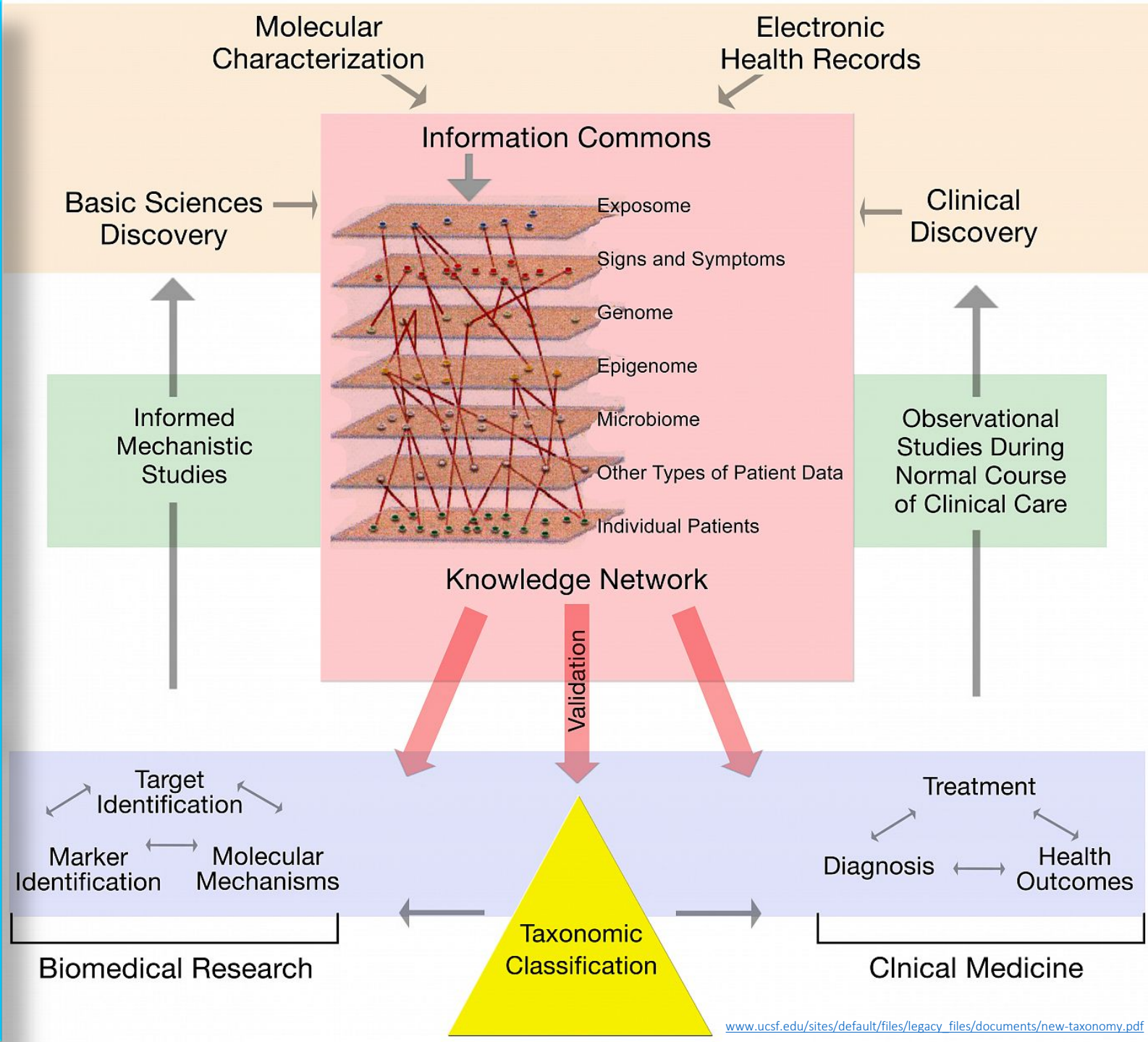

How close are we to the  
“knowledge network” of  
biological/disease  
networks?

# Phenotypic and Genotypic Networks in Human Disease

*Human Disease Network (HDN)*

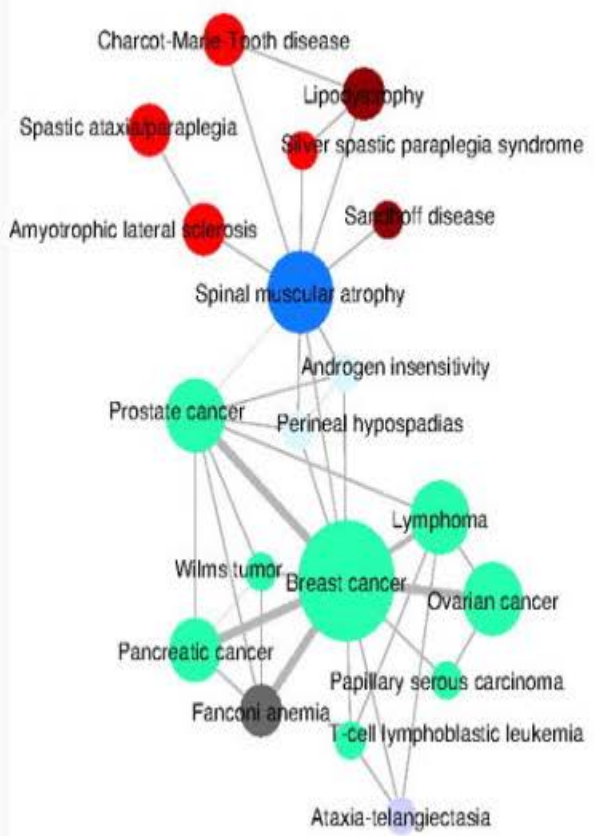

**disease phenotype      disease genome**

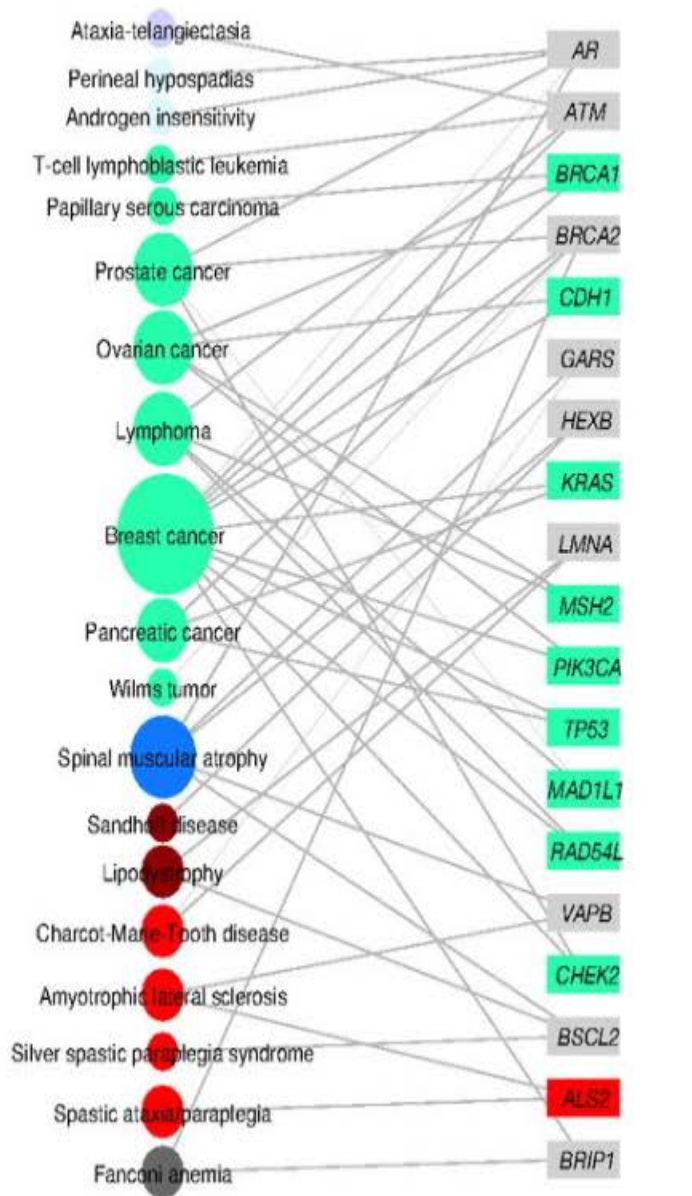

*Disease Gene Network (DGN)*

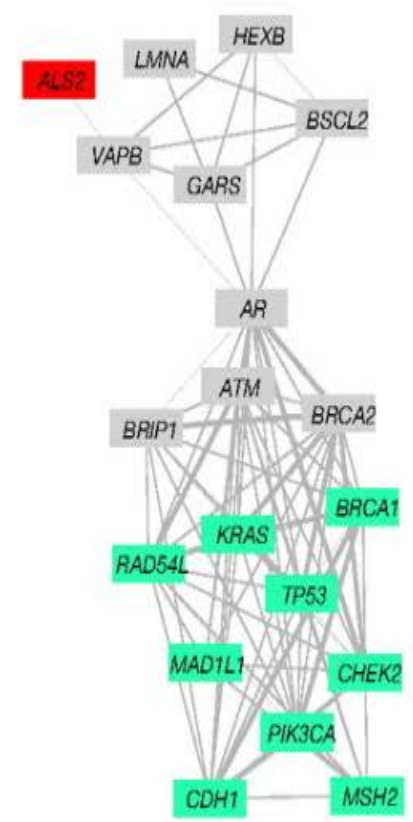

# MAPK

Growth factors  
(e.g., FGF, EGF)

Stress  
(UV irradiation)

Inflammatory cytokines  
(e.g., TNF $\alpha$ , FASL, IL-1)

**Legend:**

- Kinase
- Phosphatase
- Transcription factor
- Translation factor

**Phosphorylation:**

- P P+
- P P-

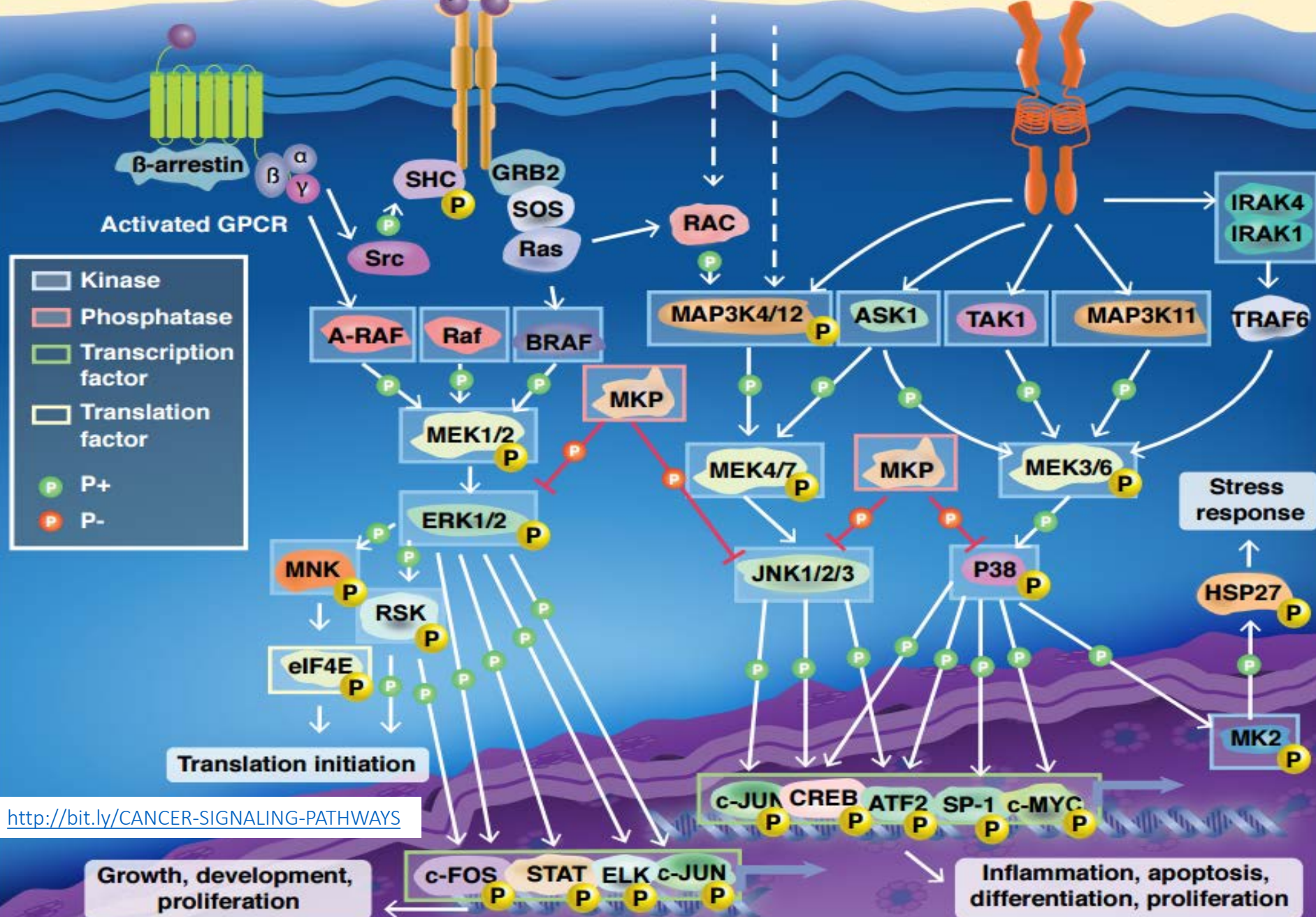

<http://bit.ly/CANCER-SIGNALING-PATHWAYS>



# NF- $\kappa$ B activation cascade in the canonical pathways

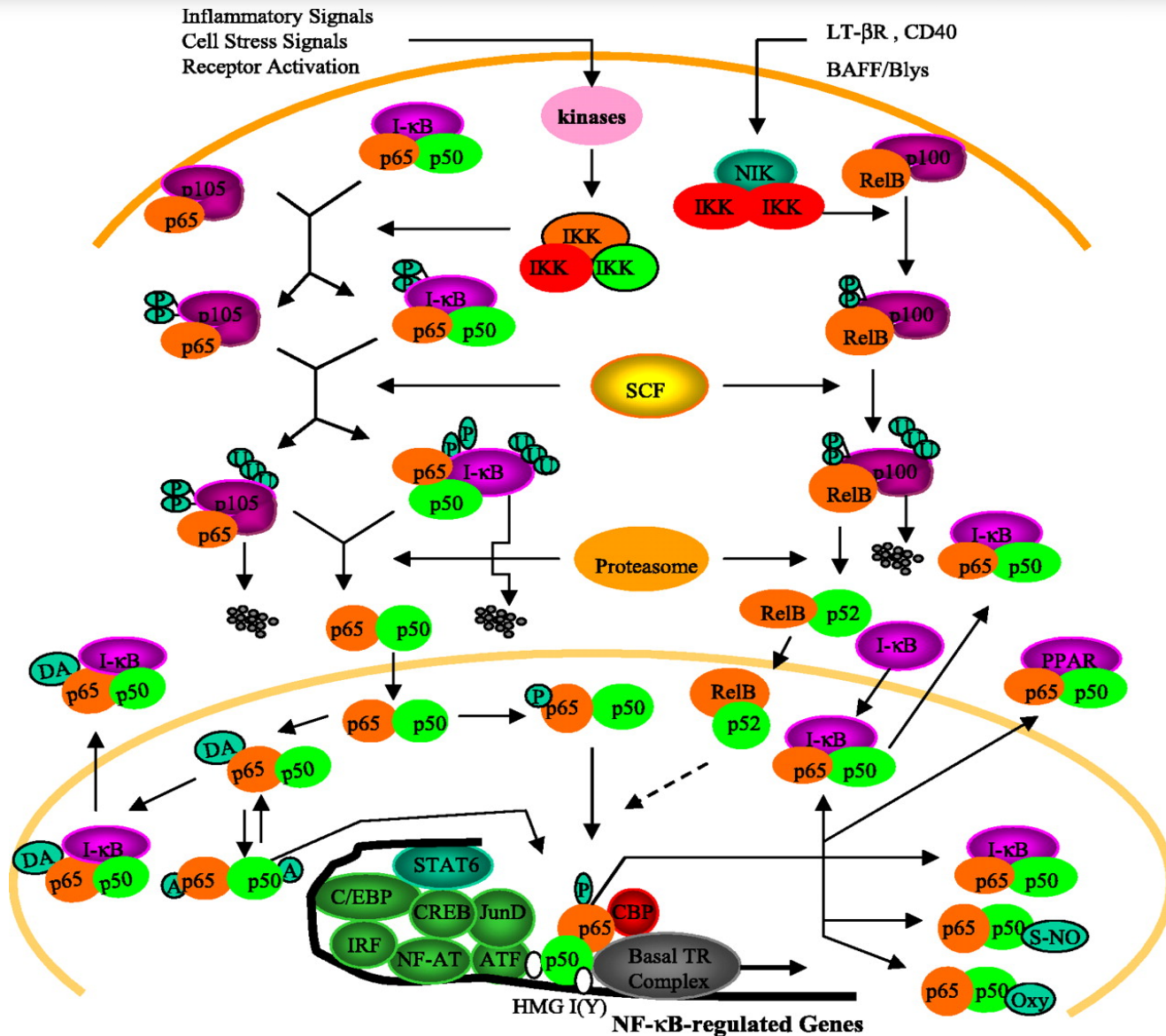

# Digital Health Market

"IBM **spun** a story about how Watson could improve cancer treatment that was superficially plausible."

--David Howard, Department of Health Policy and Management at Emory University



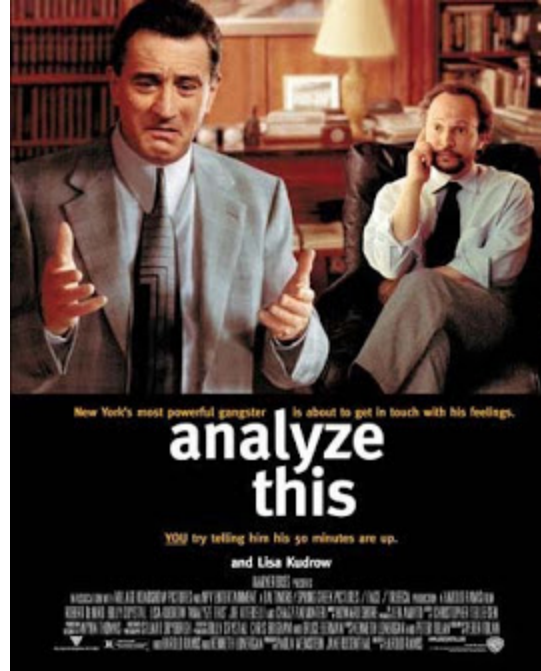

# PAY-PER-ANALYTICS

Samsung, UCSF Partner to Accelerate New Innovations  
in Preventive Health Technology

Pair Will Work to Validate Promising New Sensors and Analytics for Next-  
Generation Digital Health Solutions

2014

Revenue MKT CAP

## Global Top 40 Medical Device Manufacturers

			Revenue	MKT CAP
1	<a href="#">Johnson &amp; Johnson</a>	NYSE:JNJ	\$28.7 billion	\$294.2 billion
2	<a href="#">General Electric Co.</a>	NYSE:GE	\$18.1 billion	\$243.6 billion
3	<a href="#">Medtronic Inc.</a>	NYSE:MDT	\$17.1 billion	\$61.2 billion
4	<a href="#">Siemens AG</a>	DB:SE	\$17.0 billion	\$92.2 billion
5	<a href="#">Baxter International Inc.</a>	NYSE:BAX	\$16.4 billion	\$38.7 billion
6	<a href="#">Fresenius Medical Care AG &amp; Co. KGAA</a>	DB:FME	\$15.2 billion	\$21.1 billion
7	<a href="#">Koninklijke Philips NV</a>	ENXTAM:PHIA	\$11.8 billion	\$26.1 billion
8	<a href="#">Cardinal Health Inc.</a>	NYSE:CAH	\$11.0 billion	\$25.1 billion
9	<a href="#">Novartis AG<sup>1</sup></a>	SWX:NOVN	\$10.7 billion	\$227.5 billion
10	<a href="#">Covidien plc</a>	NYSE:COV	\$10.4 billion	\$40.1 billion
11	<a href="#">Stryker Corp.</a>	NYSE:SYK	\$9.3 billion	\$30.8 billion
12	<a href="#">Becton, Dickinson and Co.</a>	NYSE:BDX	\$8.3 billion	\$21.8 billion
13	<a href="#">Boston Scientific Corp.</a>	NYSE:BSX	\$7.2 billion	\$15.6 billion
14	<a href="#">Essilor International SA</a>	ENXTPA:EI	\$7.2 billion	\$22.9 billion
15	<a href="#">Allergan Inc.</a>	NYSE:AGN	\$6.7 billion	\$53.4 billion
16	<a href="#">St. Jude Medical Inc.</a>	NYSE:STJ	\$5.6 billion	\$17.2 billion
17	<a href="#">3M Co.</a>	NYSE:MMM	\$5.5 billion	\$84.0 billion
18	<a href="#">Abbott Laboratories<sup>2</sup></a>	NYSE:ABT	\$5.5 billion	\$61.9 billion
19	<a href="#">Zimmer Holdings Inc.</a>	NYSE:ZMH	\$4.7 billion	\$17.0 billion
20	<a href="#">Terumo Corp.</a>	TSE:4543	\$4.7 billion	\$9.0 billion

21	<a href="#">Smith &amp; Nephew plc.</a>	LSE:SN	\$4.4 billion	\$14.9 billion
22	<a href="#">Toshiba Corp.</a>	TSE:6502	\$3.9 billion	\$17.6 billion
23	<a href="#">CareFusion Corp.</a>	NYSE:CFN	\$3.8 billion	\$9.2 billion
24	<a href="#">Getinge AB</a>	OM:GETI B	\$3.8 billion	\$6.0 billion
25	<a href="#">Olympus Corp.</a>	TSE:7733 OTC:OCPNY	\$3.7 billion	\$11.7 billion
26	<a href="#">Bayer AG<sup>2</sup></a>	DB:BAYN	\$3.2 billion	\$115.0 billion
27	<a href="#">CR Bard Inc.</a>	NYSE:BCR	\$3.1 billion	\$10.6 billion
28	<a href="#">Varian Medical Systems Inc.</a>	NYSE:VAR	\$3.0 billion	\$8.3 billion
29	<a href="#">DENTSPLY International Inc.</a>	NasdaqGS:XRAY	\$3.0 billion	\$6.4 billion
30	<a href="#">Ship Healthcare Holdings Inc.</a>	TSE:3360	\$2.5 billion	\$1.3 billion
31	<a href="#">Paul Hartmann AG</a>	DB:PHH2	\$2.5 billion	\$1.4 billion
32	<a href="#">Hologic Inc.</a>	NasdaqGS:HOLX	\$2.5 billion	\$6.6 billion
33	<a href="#">Nipro Corp.<sup>4</sup></a>	TSE:8086	\$2.3 billion	\$1.4 billion
34	<a href="#">Colonlast A/S</a>	CPSE:COLO B	\$2.2 billion	\$17.9 billion
35	<a href="#">Sonova Holdings</a>	SWX:SOON	\$2.2 billion	\$10.4 billion
36	<a href="#">Danaher Corp.<sup>5</sup></a>	NYSE:DHR	\$2.1 billion	\$38.6 billion
37	<a href="#">Edwards Lifesciences</a>	NYSE:EW	\$2.1 billion	\$11.0 billion
38	<a href="#">Intuitive Surgical Inc.</a>	NasdaqGS:ISRG	\$2.1 billion	\$16.6 billion
39	<a href="#">MIRACA Holdings Inc.</a>	TSE:4544	\$2.0 billion	\$2.4 billion
40	<a href="#">Drägerwerk AG &amp; Co. KGaA<sup>6</sup></a>	DB:DRW3	\$2.0 billion	\$1.4 billion

# Global Medical Technology Product Market 2012

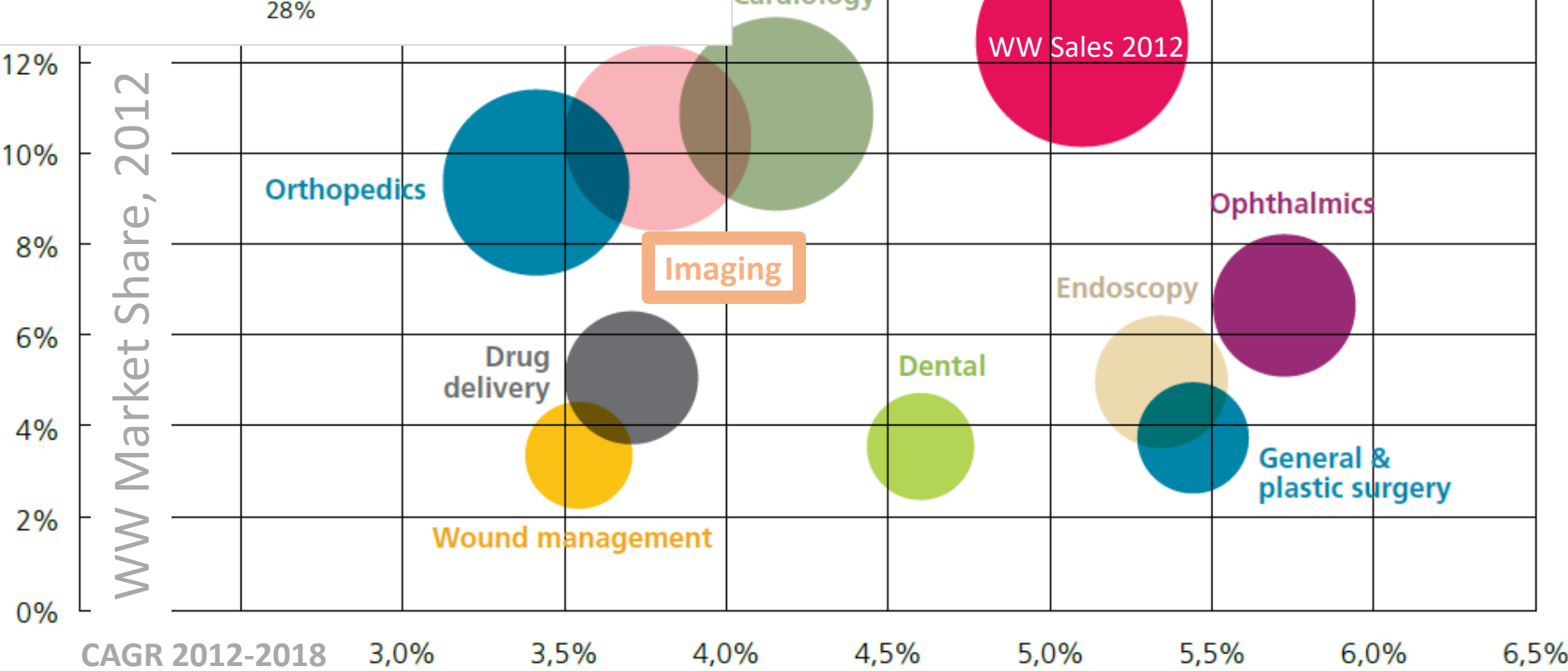
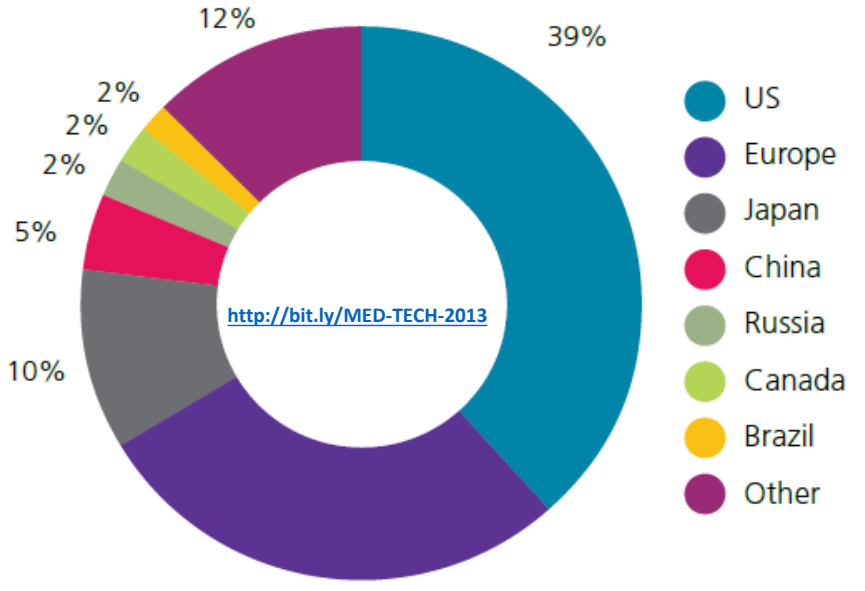

# US Funding for Digital Health

■ Funding in USD Billions

~2x

\$3.5

\$4.3

\$5.3

\$6.5

2014

2015

2016

2017



# GE Investing in Healthcare Startups

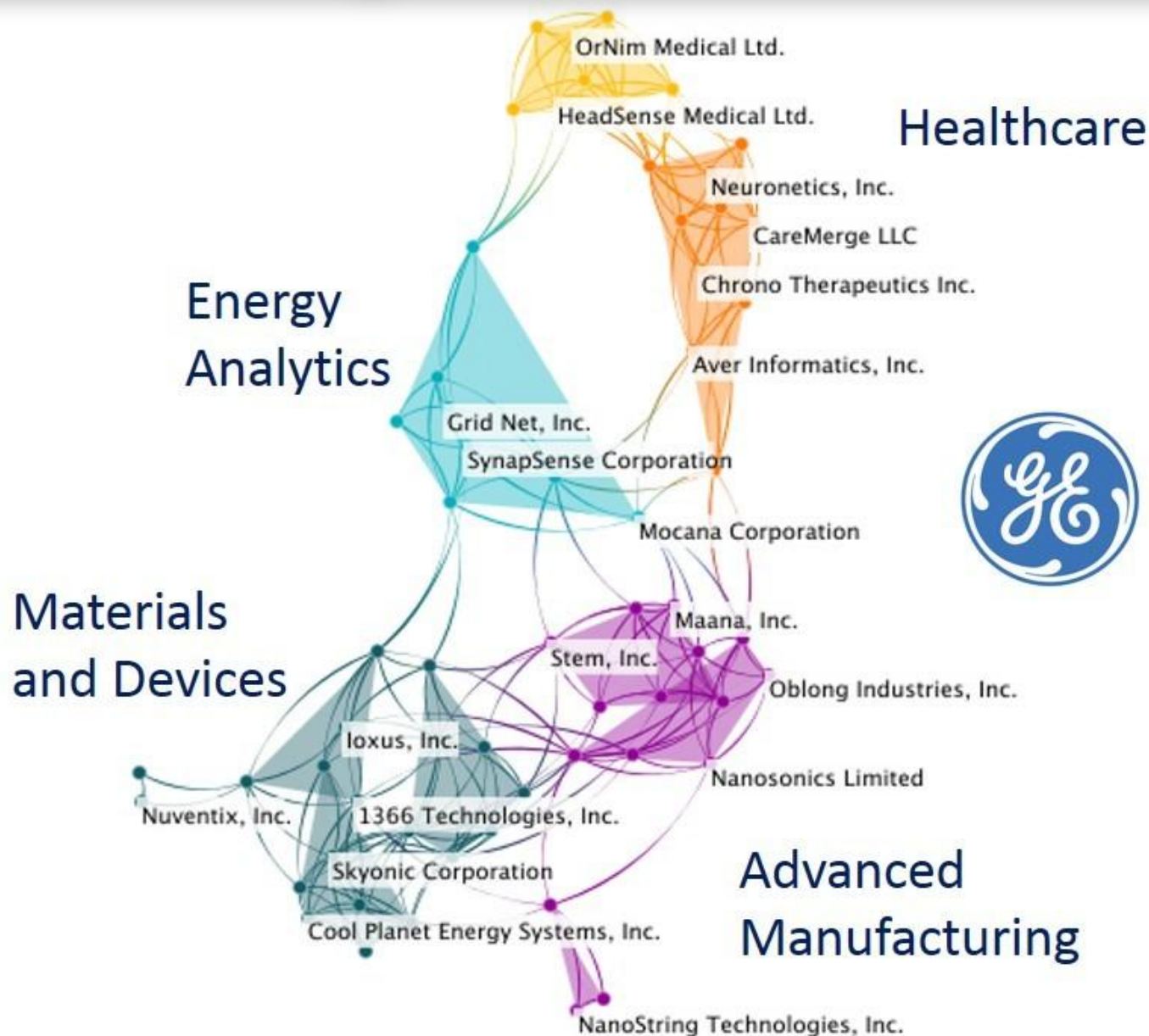

# IoT Investment in the Healthcare Industry

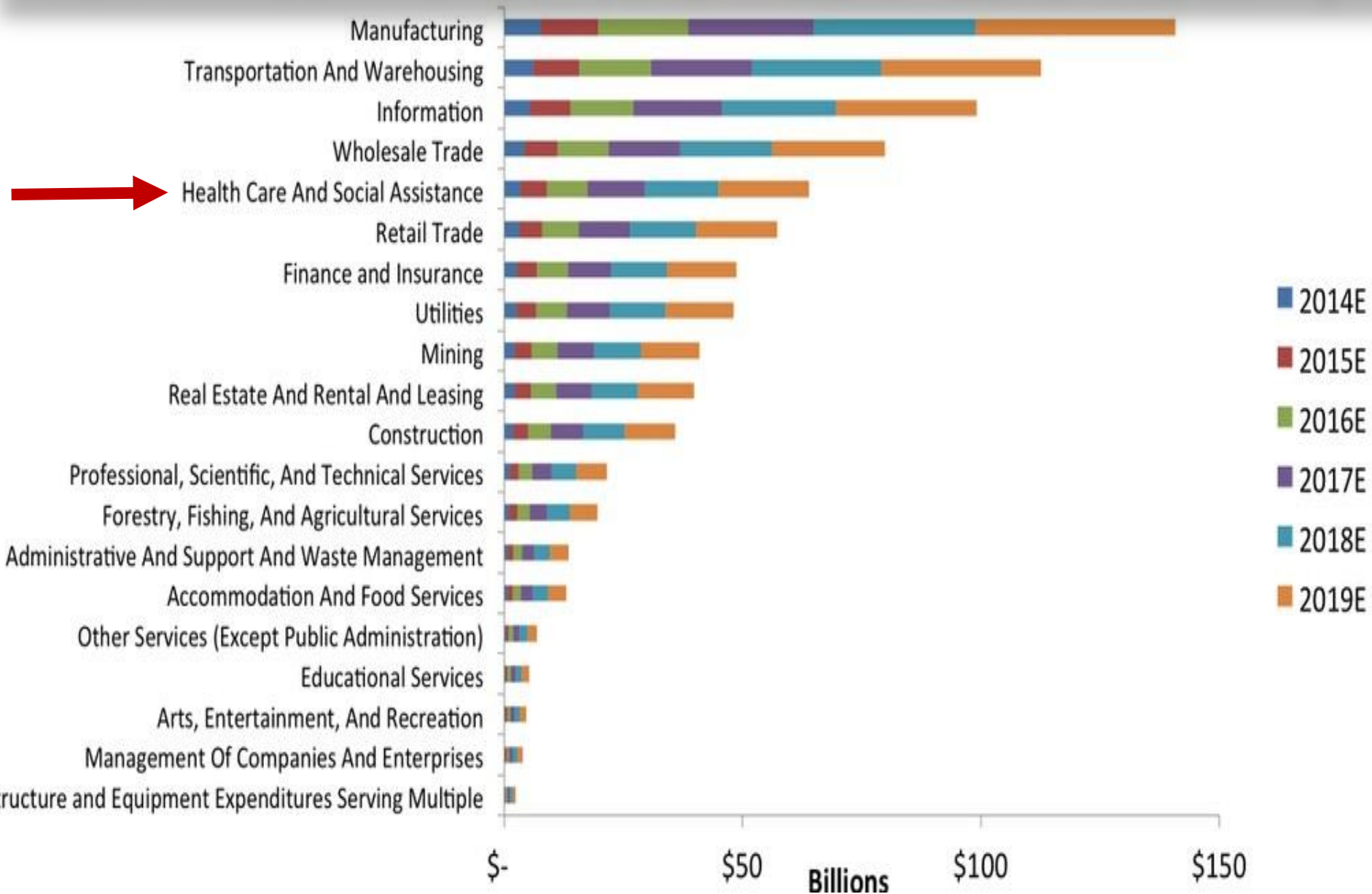

# Wearable Tech Exits (valuation at time of exit)

\$M, 2010-2015

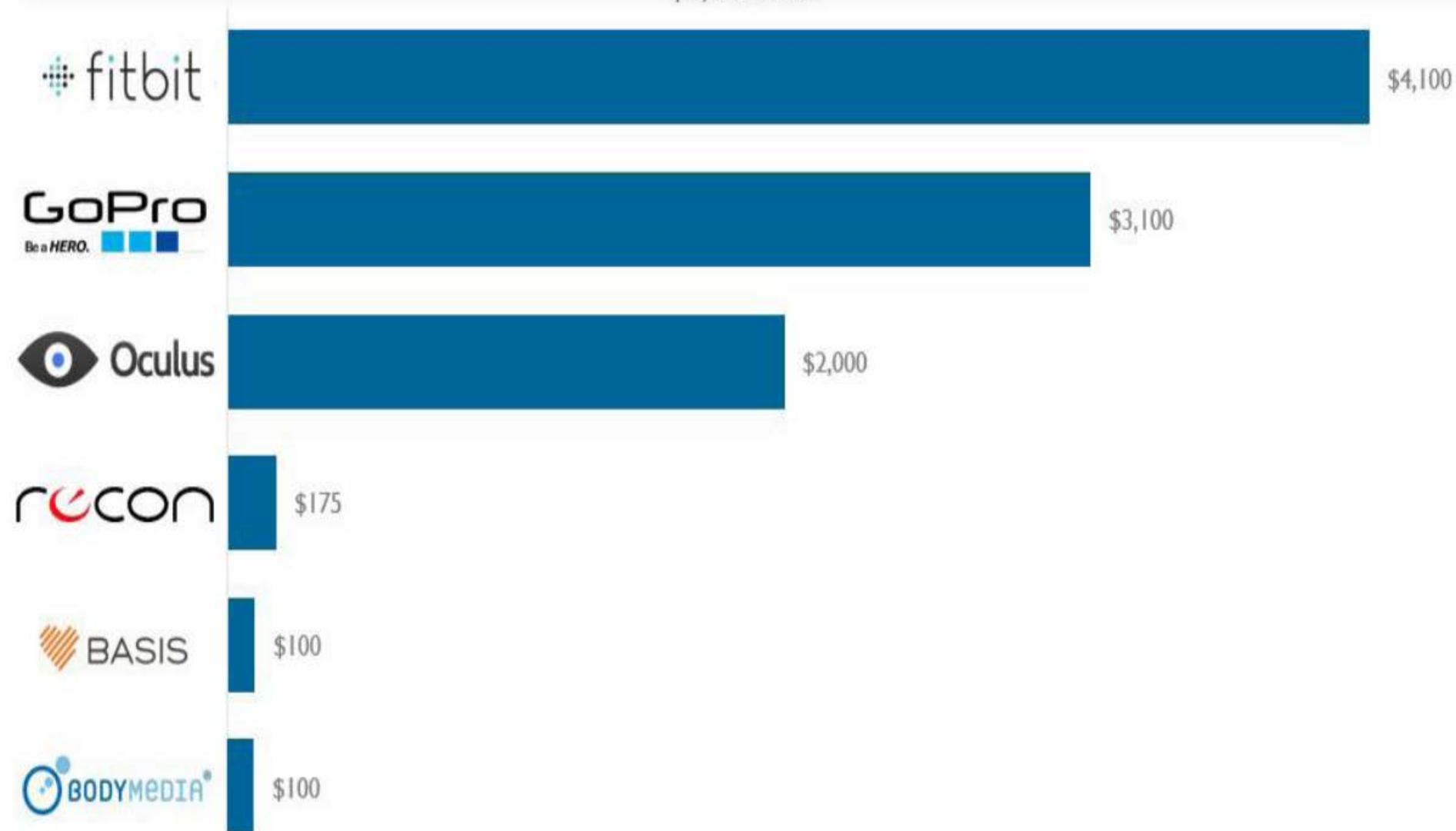

# Healthcare Platforms?

Systems of Digital Twins for Health and Wellness

# Integrating Ubiquitous Analytics in Real-Time with Data, Information, Application

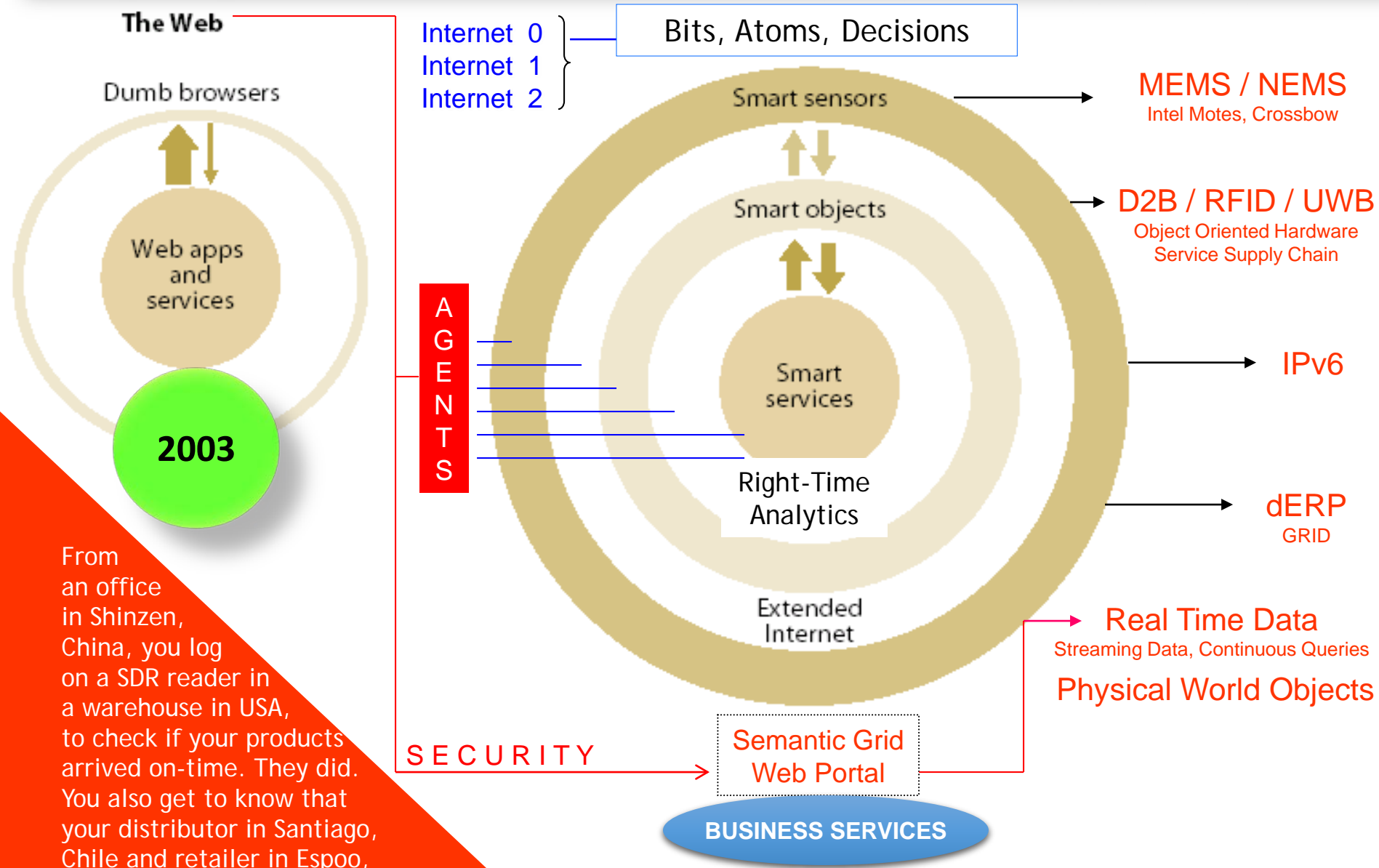

From an office in Shinzen, China, you log on a SDR reader in a warehouse in USA, to check if your products arrived on-time. They did. You also get to know that your distributor in Santiago, Chile and retailer in Espoo, Finland also checked the delivery status, moments before you logged on.

# Healthcare Data Integration and Interoperability Platform is a Quintessential Global Infrastructure

Infrastructural technologies, in contrast, offer far more value when shared than when used in isolation. Imagine yourself in the early nineteenth century, and suppose that one manufacturing company held the rights to all the technology required to create a railroad. If it wanted to, that company could just build proprietary lines between its suppliers, its factories, and its distributors and run its own locomotives and railcars on the tracks. And it might well operate more efficiently as a result. But, for the broader economy, the value produced by such an arrangement would be trivial compared with the value that would be produced by building an open rail network connecting many companies and many buyers. The characteristics and economics of infrastructural technologies, whether railroads or telegraph lines or power generators, make it inevitable that they will be broadly shared—that they will become part of the general business infrastructure.

Nicholas Carr in Harvard Business Review, 2003 • <https://hbr.org/2003/05/it-doesnt-matter>

# Investment to Create and Deploy Integrated Healthcare Platforms

The trap that executives often fall into, however, is assuming that opportunities for advantage will be available indefinitely. In actuality, the window for gaining advantage from infrastructural technology is open only briefly. When the technology's commercial potential begins to be broadly appreciated, huge amounts of cash are inevitably invested in it, and its build out proceeds with extreme speed. Railroad tracks, telegraph wires, power lines—all were laid or strung in a frenzy of activity. In the 30 years between 1846 and 1876, reports Eric Hobsbawm in *The Age of Capital*, the world's rail trackage increased from 17,424 km to 309,641 km. During this same period, total steamship tonnage also exploded, from 139,973 to 3,293,072 tons. The telegraph system spread even more swiftly. In Continental Europe, there were just 2,000 miles of telegraph wires in 1849; 20 years later, there were 110,000 miles. The pattern continued with electrical power. The number of central stations operated by utilities grew from 468 in 1889 to 4,364 in 1917, and the average capacity of each increased tenfold.

Nicholas Carr in Harvard Business Review, 2003 • <https://hbr.org/2003/05/it-doesnt-matter>



# Platform Synthesis?

Integrated health data – simulate equivalent of industrial digital twins



The concept of “digital twins” is one of a “soft companion” to a real-world entity, eg, industrial plant (entire system), jet engine sensor (sub-system), gear box (parts), maintenance (process), car tire (product) or a city (system of systems). An individual and her health profile may generate a “digital twin” with her data feed from metabolomics, vital signs and other medical devices. Hence the need for platforms, data synthesis, analytics and real-time risk prediction, alerts or treatment.

<https://www.altoros.com/blog/optimizing-the-industrial-internet-of-things-with-digital-twins/>

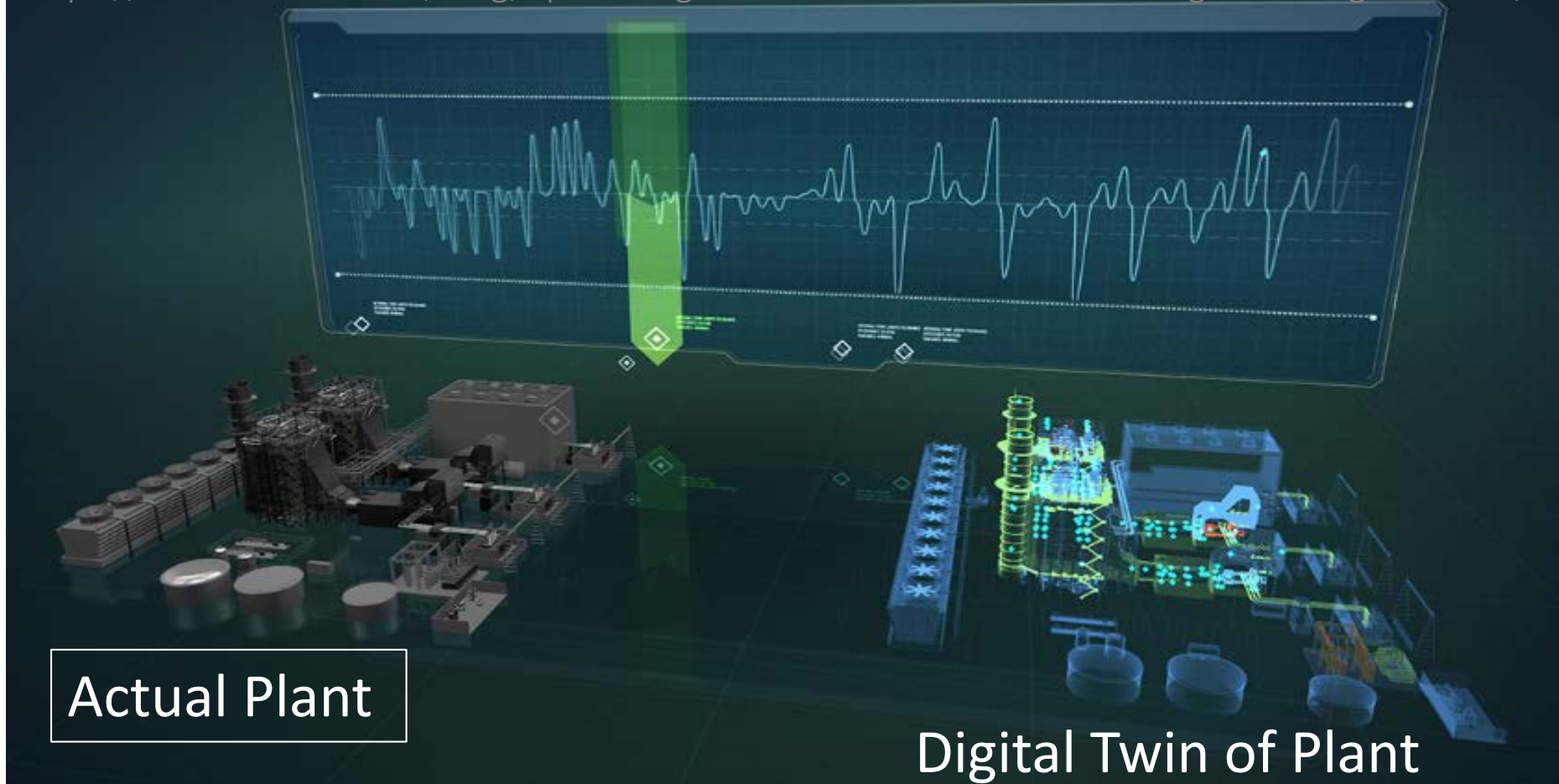

Explore – Industrial “Digital Twins” here <https://dspace.mit.edu/handle/1721.1/104429>



# Pursuit of Ideas

Let us re-visit  
nanotube  
radios

The Industrial Internet  
 The Industrial Internet of Things  
 The Industrial Internet of Healthcare

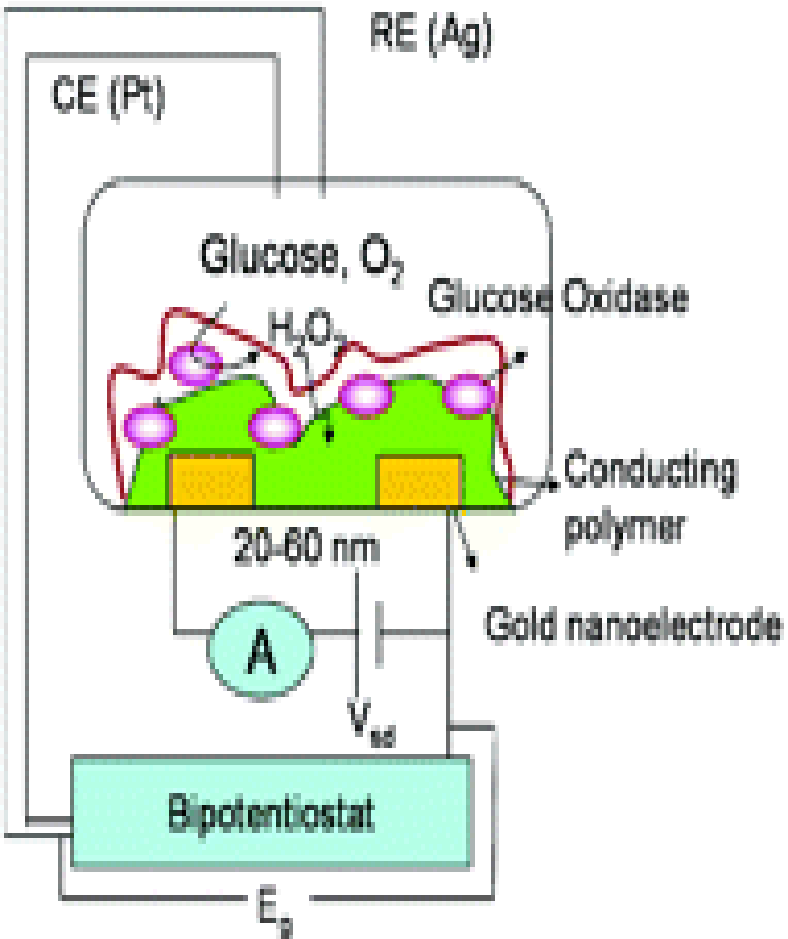

Blood Glucose Nano-sensor

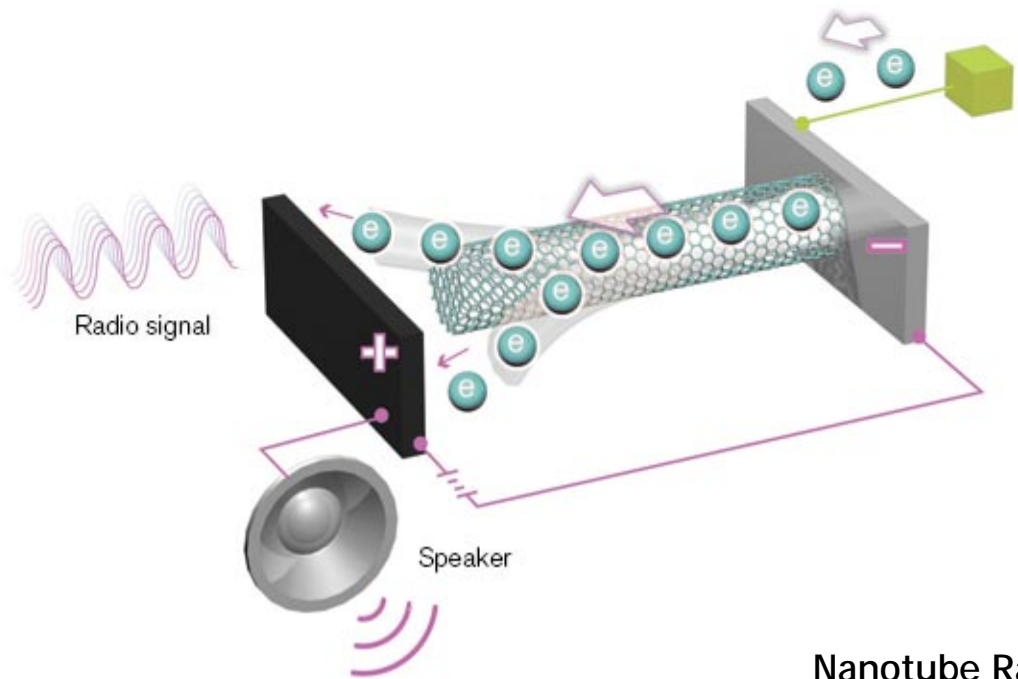
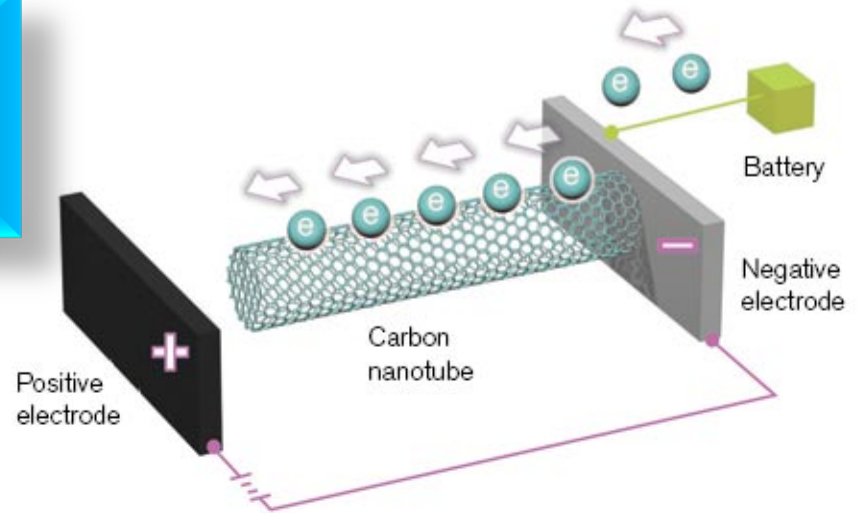

Nanotube Radio

What about biological  
radios inside our body?

NOVEMBER 9, 2015

# C&EN

CHEMICAL & ENGINEERING NEWS

**CPhI IN MADRID**

Optimism unstoppable at  
fine chemicals expo **P.18**

**CHEMCENSUS TURNS 30**

ACS member makeup and  
earnings in review **P.30**

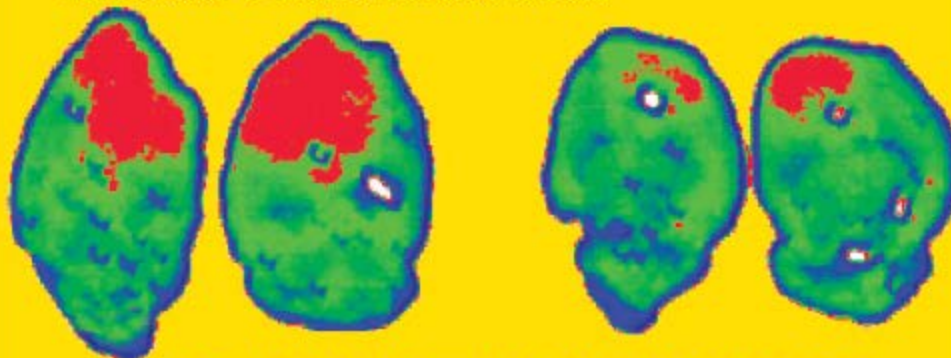

## TERAHERTZ IMAGING

Technology could aid disease diagnosis  
but faces challenges **P.10**

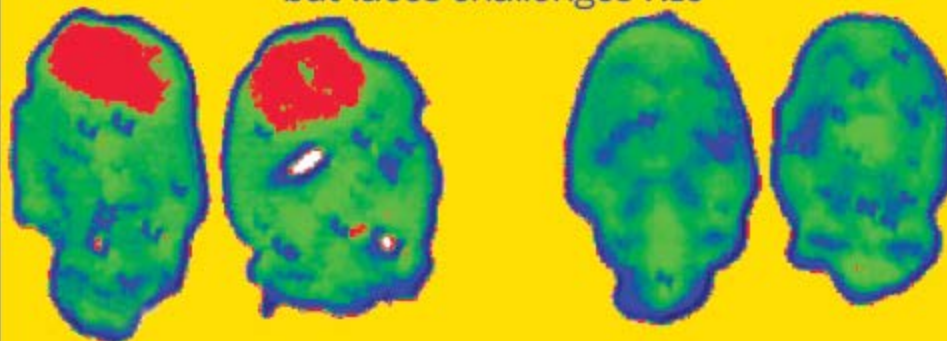

PUBLISHED BY THE AMERICAN CHEMICAL SOCIETY

<http://bit.ly/Terahertz-Imaging>

# Proteins are Radios

We can detect, diagnose and correct RF radiation.

Can we?

# Protein Electrodynamics

*Nature* Vol. 267 16 June 1977

## articles

### Dynamics of folded proteins

**J. Andrew McCammon, Bruce R. Gelin & Martin Karplus**

Department of Chemistry, Harvard University, Cambridge, Massachusetts 02138

*The dynamics of a folded globular protein (bovine pancreatic trypsin inhibitor) have been studied by solving the equations of motion for the atoms with an empirical potential energy function. The results provide the magnitude, correlations and decay of fluctuations about the average structure. These suggest that the protein interior is fluid-like in that the local atom motions have a diffusional character.*

## The Nobel Prize in Chemistry 2013



Photo: A. Mahmoud  
**Martin Karplus**

Prize share: 1/3



Photo: A. Mahmoud  
**Michael Levitt**

Prize share: 1/3

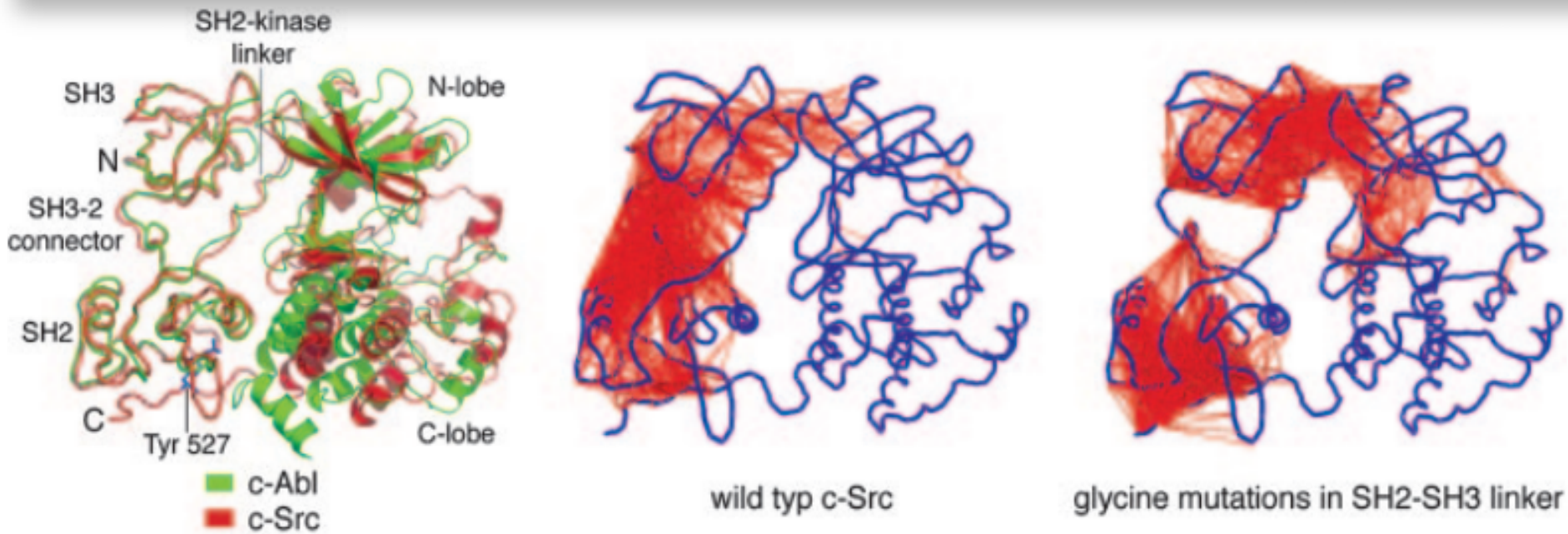

Photo: A. Mahmoud  
**Arieh Warshel**

Prize share: 1/3

The Nobel Prize in Chemistry 2013 was awarded jointly to Martin Karplus, Michael Levitt and Arieh Warshel "for the development of multiscale models for complex chemical systems".



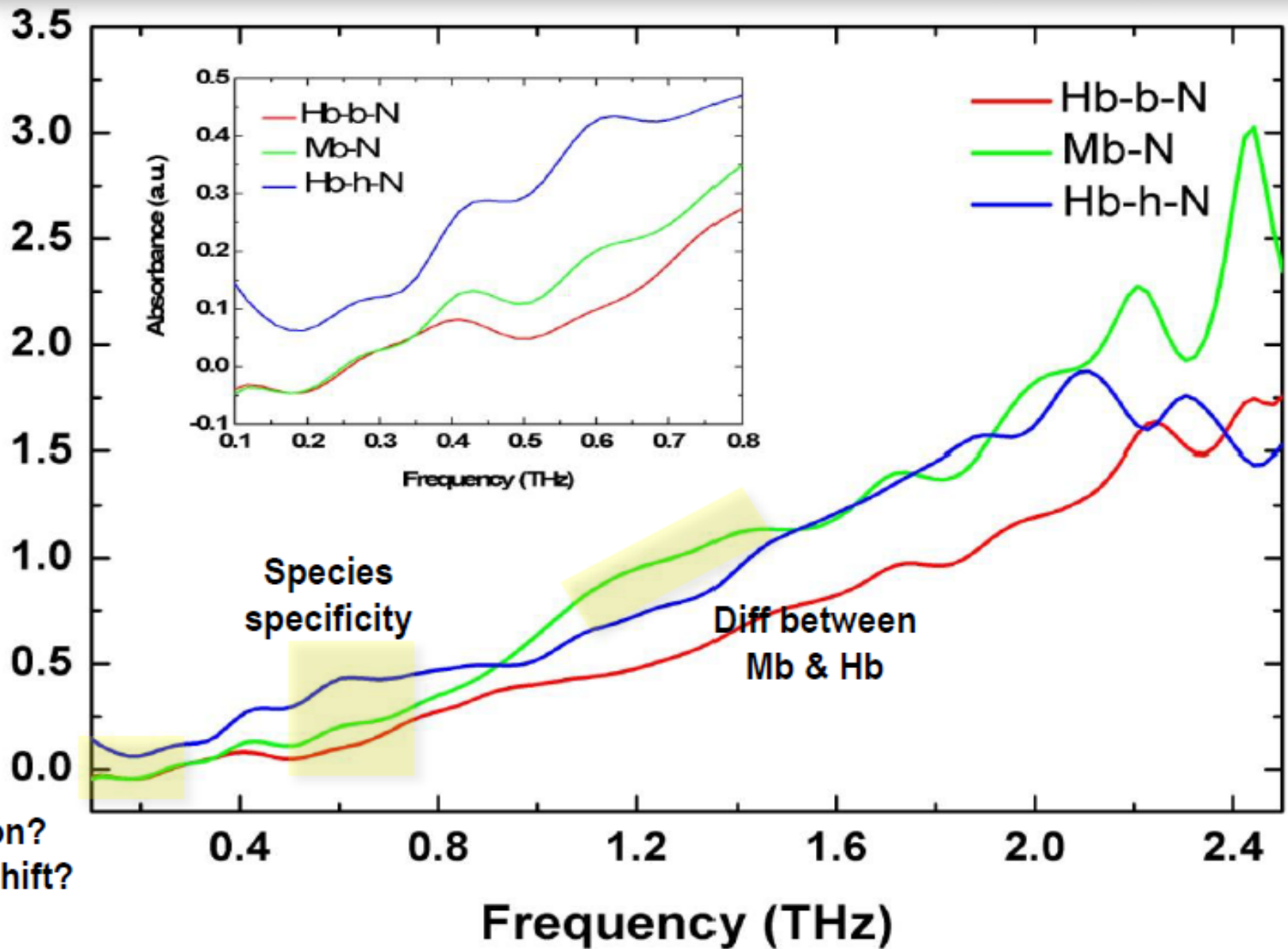

**Fig. 5.** Structure and dynamics of the Src and Abl kinases. (*Left*) The structures of c-Abl (green) and c-Src (red) are shown superimposed on their SH2 and SH3 domains (69, 70, 75). Note the dissimilarity in the conformation of the kinase domains. (*Center and Right*) The results of unbiased molecular dynamics simulations of c-Src. Residues in different domains that move in a correlated manner in the simulation are linked by a red line. These correlations were calculated by superimposing each instantaneous structure in the simulation on the C-terminal lobe of the kinase domain, and motions that are correlated to the C-terminal lobe are removed by this procedure. (*Right*) The mutation of residues in the SH2–SH3 linker to glycine reduces the correlation in the dynamics of these domains. Similar results were obtained for c-Abl. (Modified from refs. 8 and 75.)

# Proteins Absorb Radio Frequency (RF) at the TeraHertz Range

Difference spectra with control

Absorbance (a.u.)



Emission?  
Stokes Shift?

# Terahertz 101

Light with submillimeter wavelengths and a frequency range of roughly 0.1 to 10 THz, or 3 to 300  $\text{cm}^{-1}$ , is known as terahertz radiation. It can penetrate plastics, paper, and textiles, but it is absorbed strongly by water, making it a sensitive probe of biological tissue. Unlike the relatively high-frequency stretching and bending motions that infrared light induces in individual water molecules (above), THz light causes groups of water molecules to coalesce and disassemble repeatedly (left).

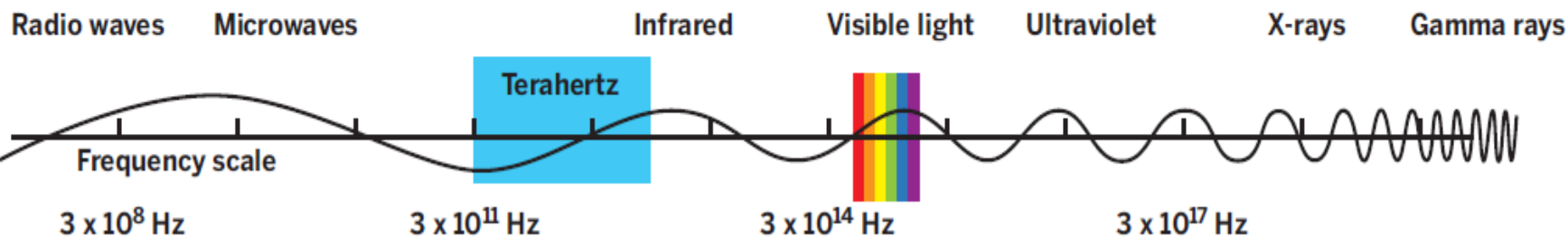
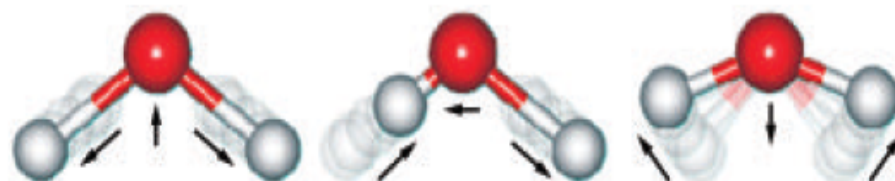
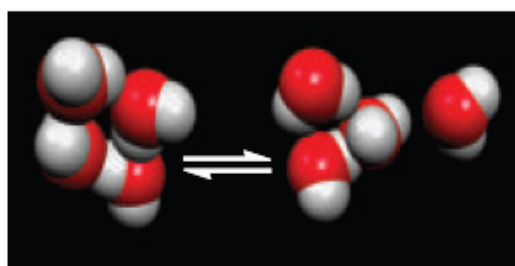

# Axioms of Protein Electrodynamics

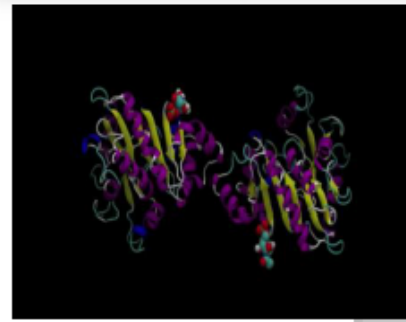

1. Proteins Vibrate

Terahertz radiation from bacteriorhodopsin reveals correlated primary electron and proton transfer processes

PNAS

PNAS | May 13, 2008 | vol. 105 | no. 19

G. I. Groma<sup>1</sup>, J. Hebling<sup>2</sup>, I. Z. Kozma<sup>3</sup>, G. Váró<sup>4</sup>, J. Hauer<sup>5</sup>, J. Kuhl<sup>6\*</sup>, and E. Reder<sup>6</sup>

<sup>1</sup>Institute of Biophysics, Biological Research Center of the Hungarian Academy of Sciences, H-6236, Szeged, Hungary; <sup>2</sup>Department of Experimental Physics, University of Péc, H-7624, Pécs, Hungary; <sup>3</sup>Chair for FemtoMolecular Optics, Ludwig-Maximilians-University, D-80539 Munich, Germany; and <sup>4</sup>\*\*Max Planck Institute for Solid State Research, D-70569 Stuttgart, Germany.

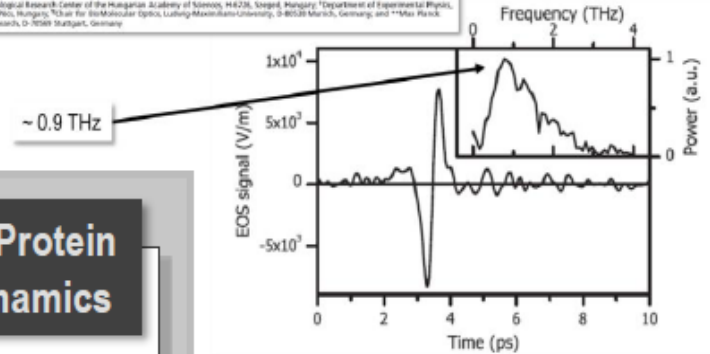

## Axioms of Protein Electrodynamics

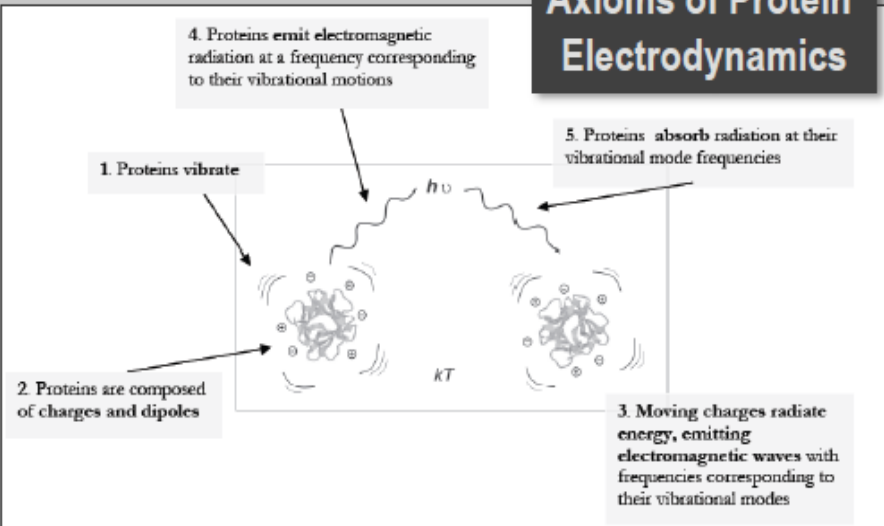

4. Proteins emit THz radiation

2. Proteins Are Charged

### The Poisson-Boltzmann Equation

The classical treatment of electrostatic interactions in solution is based on the Poisson-Boltzmann equation (PBE)

$$\nabla \cdot [\epsilon(r)\nabla \phi(r)] - \epsilon(r)\kappa(r)\sinh[\phi(r)] + 4\pi\rho(r)/kT = 0 \quad (1)$$

where  $\phi(r)$  is the dimensionless electrostatic potential in units of  $kT/q$  ( $k$  is the Boltzmann constant,  $T$  is the absolute temperature, and  $q$  is the charge on a proton),  $\epsilon$  is the dielectric constant, and  $\rho$  is the fixed charge density (in proton charge units). The term  $\kappa^{-1} = \lambda_D = 8\pi q^2 l / \epsilon kT$ , where  $\lambda$  is the Debye length and  $l$  is the ionic strength of the bulk solution. The variables  $\phi$ ,  $\epsilon$ ,  $\kappa$ , and  $\rho$  are all functions of the position vector  $r$ .

Science

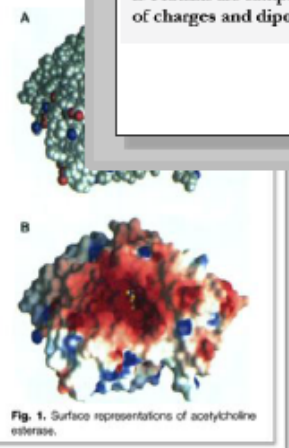

3. Maxwell's Equations

$$\begin{aligned} \nabla \cdot \mathbf{E} &= 0 & \nabla \times \mathbf{E} &= -\frac{\partial \mathbf{B}}{\partial t} \\ \nabla \cdot \mathbf{B} &= 0 & \nabla \times \mathbf{B} &= \frac{1}{c^2} \frac{\partial \mathbf{E}}{\partial t} \end{aligned}$$

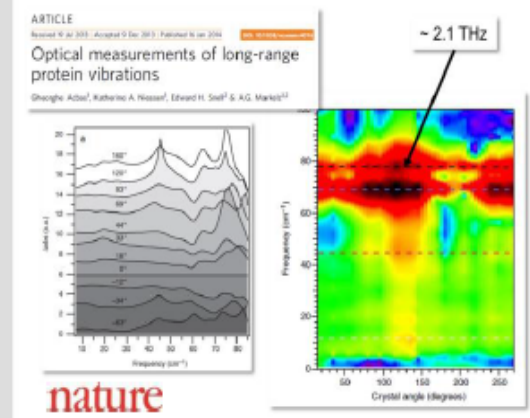

5. Proteins absorb THz radiation

# Absence of Protein • Absence of Vibration

## *Concept of protein vibration as a signature*

### Police Tool Targets Guns

Kelly Says 'T-Ray' Can Indicate a Firearm Under Clothing

By TAMER EL-GHOBASHY

Jan. 23, 2013 9:20 p.m. ET

The New York Police Department is testing a new device it says can detect firearms concealed beneath layers of clothing, a high-tech crime-fighting tool seemingly torn from the pages of science fiction.

The so-called T-Ray machine detects terahertz radiation, a high-frequency electromagnetic natural energy that is emitted by people and can penetrate many materials, including clothing.



[Enlarge Image](#)

The T-Ray machine. NYPD

"If something is obstructing the flow of that radiation, for example a weapon, the device will highlight that object," said Commissioner Raymond Kelly, who described the device Wednesday in a speech at the Waldorf-Astoria Hotel.

News of the device prompted concerns from privacy advocates, though they also saw a potential benefit: It might render unnecessary the legally disputed police

policy of stopping and frisking people who haven't been first identified as suspects in crimes.

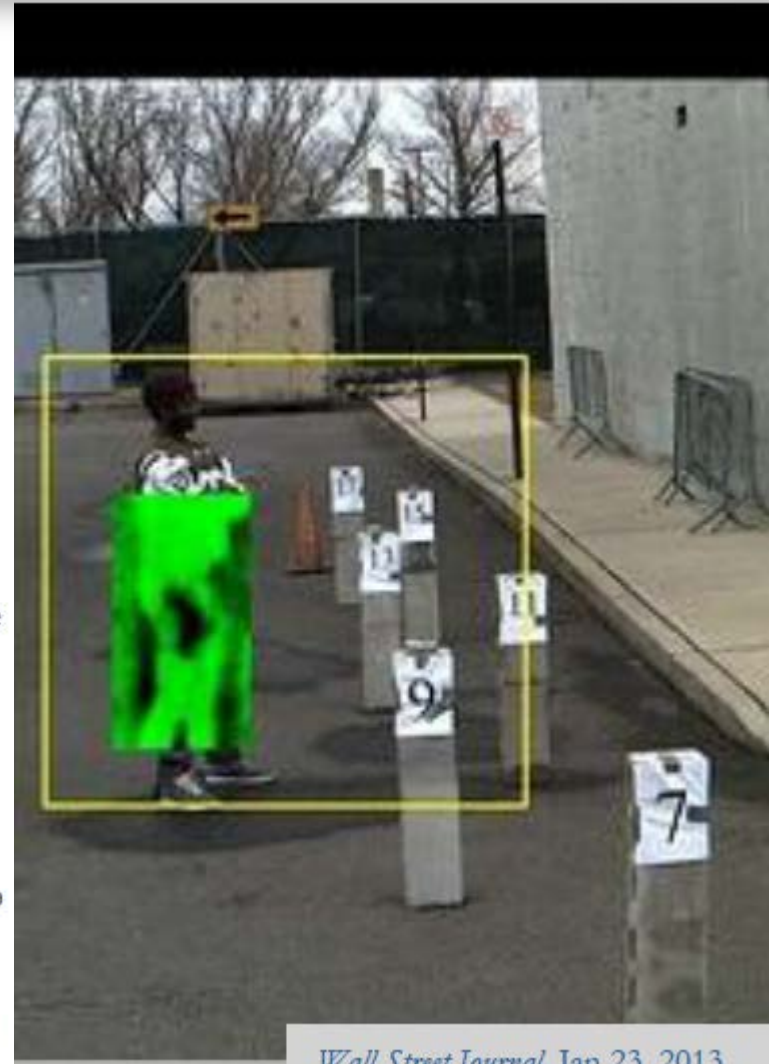

# TeraHertz Medicine

## *Concept of protein vibration as a signature*

- Is the protein signature sufficiently specific as a tool for protein structure, conformation and configuration?
- Can it be used for diagnosis to differentiate between normal and mutant proteins or degraded products/peptides?
- Can RF modulation reconfigure protein structure to activate “normal” function or detect/deactivate harmful proteins?

Do different proteins vibrate at **different frequencies**?

Yes

Can one influence protein function by modulating their vibrations?

Unknown

How far might protein electrodynamic wave fields be expected to propagate?

? 1 - 2 mm

Protein motion **anharmonicity**: how significant?

May depend

Could proteins communicate “over a distance”?

Unknown

Can we identify different proteins based on their spectrum?

Yes, but not easy (now)

Could protein electrodynamics mediate specific attractive forces between proteins?

Unknown

**Diagnosis**

**Treatment**

# Key technical challenges in TeraHertz Medicine

*Concept of protein vibration as a signature is clouded by water*

The “noise” from RF vibration of water molecules may significantly distort the TeraHertz profile.

How do we correct the error due to this (Shannon) “noisy channel” related to water?

Is this a signal processing issue? Can novel algorithms subtract the “noise” due to water?

What about the application of the principles of (Shannon, Kalman-Bucy) error correcting algorithms?

[https://en.wikipedia.org/wiki/Kalman\\_filter](https://en.wikipedia.org/wiki/Kalman_filter)

<http://news.mit.edu/2010/explained-shannon-0115>

<http://www.cs.cmu.edu/~guyb/realworld/errorcorrecting.html>

<http://www.cs.cmu.edu/~aarti/Class/10704/lec16-shannonnoisythrm.pdf>

[These suggestions are due to SD]

- **Range: 0.2 – 1THz** for biomedical applications  
(e.g. proteins)

- **Tunability: cw** spectroscopy  
(water windows)

- **Pulsed: (~ 10 ps)**  
Minimize water  
relaxation effects

- **High power:**  
Beer-Lambert, etc.

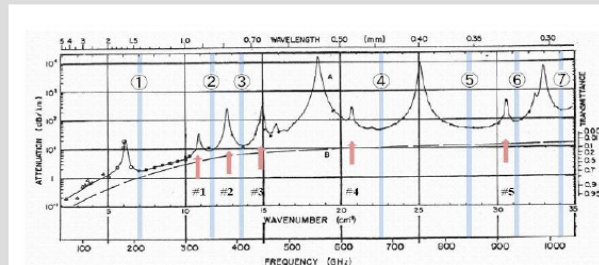

*Optics Express (2011), 19(9)*

<http://bit.ly/OGAN-GUREL-BIO>

# *Data Curation Concepts from Laminar Flow in TeraHertz Medicine? Can we subtract RF vibration due to water from protein vibration?*

**The data (TeraHertz profile) is a mix of RF due to water and protein (which needs to be separated).**

**Is this a data curation problem? Are we observing related signal/noise issues in big data analytics?**

**Are there any concepts related to data curation which may be triggered by laminar flow?**

**<http://bit.ly/LAMINAR-FLOW-DATA-CURATION-CONCEPT>**

*[These suggestions are due to SD]*

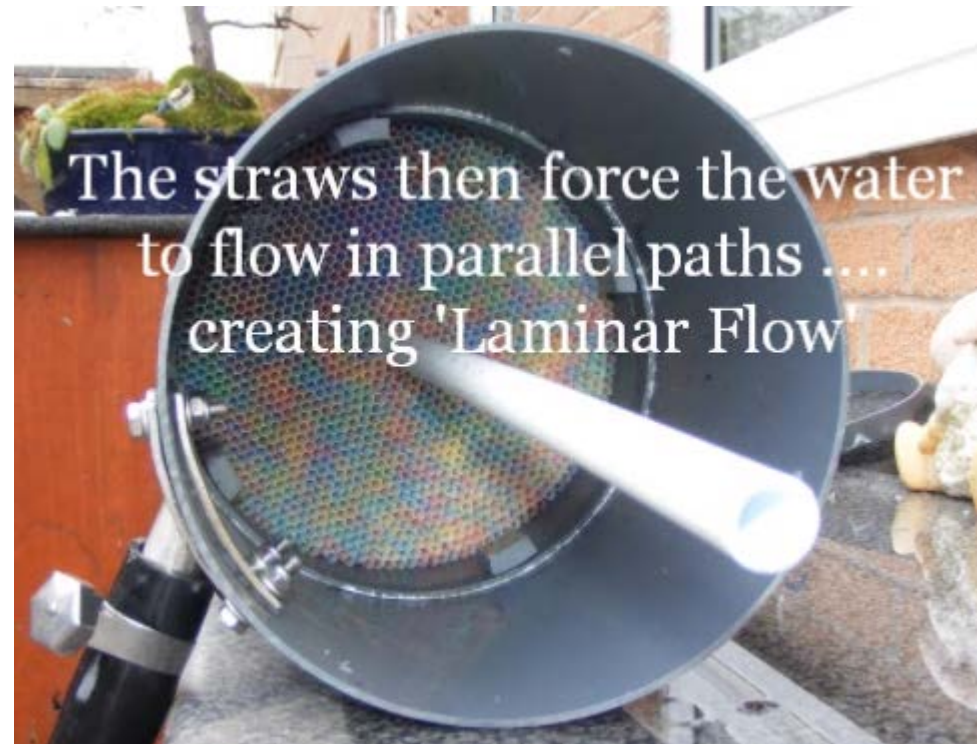
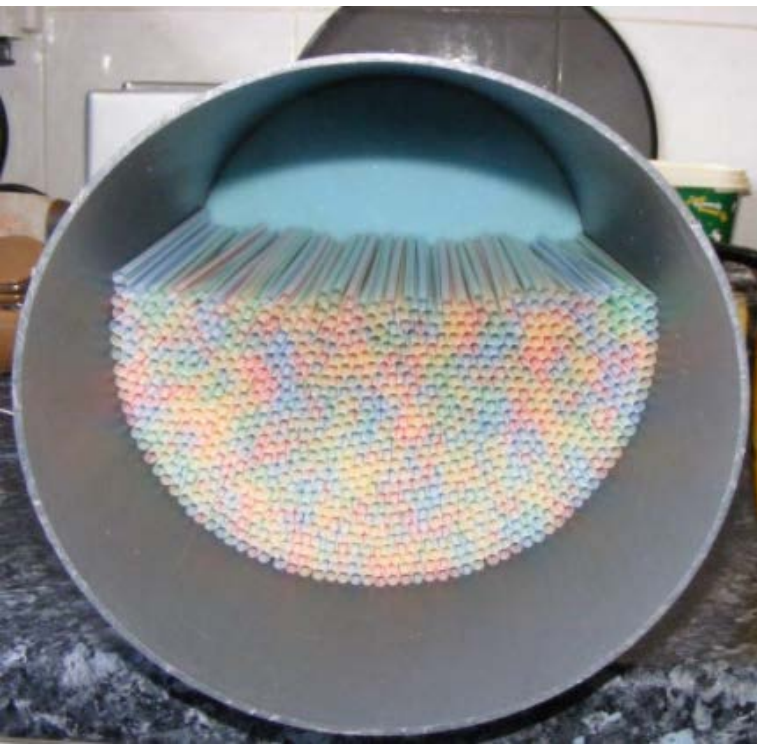



What if I want only one  
take-away from MIoT?

# Reality Check Arsenic in Water (Bangladesh)



Internet  
of  
Systems

MIoT

# Health IoT – Impact of Clean Water

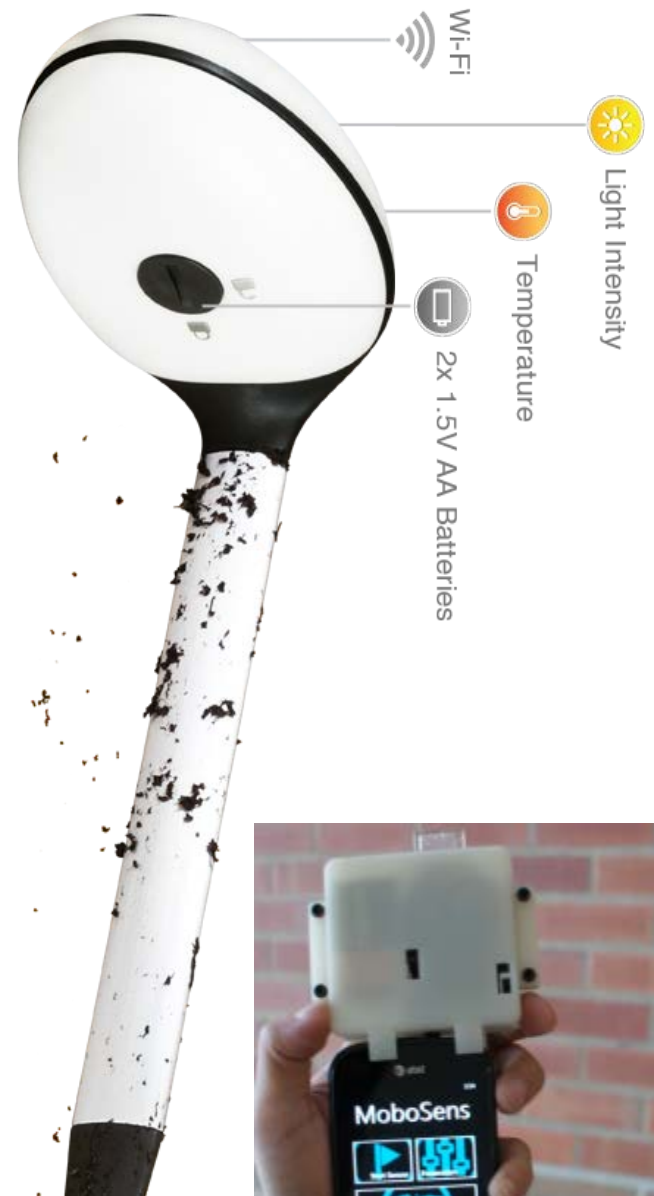

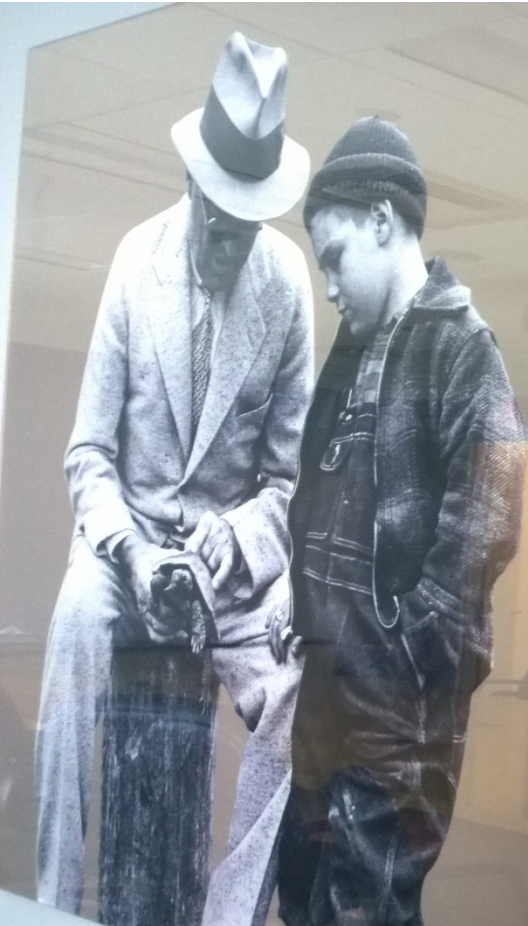

*"Some men have thousands of reasons why they cannot do something, when all they need is one reason why they can."*

**- Willis R. Whitney**  
(1868 - 1958)

# Advancing the vast landscape of Medical IoT

- Dr Julian Goldman – Massachusetts General Hospital – [www.mdnp.org](http://www.mdnp.org)
- Professor Dina Katabi – Massachusetts Institute of Technology – [Wireless Lab, MIT](http://Wireless Lab, MIT)
- Dr Gary Gottlieb – Former CEO, Partners; CEO, Partners in Health ([www.pih.org](http://www.pih.org))
- Dr Atul Gawande – Professor of Surgery, Harvard Medical School ([www.ariadnelabs.org](http://www.ariadnelabs.org))
- Dr Pietro Valdastri – Professor of Mechanical Engineering, Vanderbilt University ([STORM](http://STORM))
- Dr Prashant Jain – DOTRI (Los Alamos National Lab) <http://bit.ly/EMG-BioFeedback>
- Dr Ashis Banerjee – University of Washington <https://sites.google.com/site/ashisbanerjee/>
- Dr Gin Jose – University of Leeds <http://bit.ly/BLOOD-FREE-BLOOD-GLUCOSE>
- Dr Ram Dantu – University of North Texas <http://www.cse.unt.edu/~rdantu/>
- Please review → <http://bit.ly/IOT-MIT>
- Security → <http://bit.ly/SECURITY-HIT-NIST>
- For potential R&D test beds please contact Dr Shoumen Palit Austin Datta, MIT / MGH-HMS ● [shoumen@mit.edu](mailto:shoumen@mit.edu)

*Thank you – but I have created nothing new*

This document suggests ideas and comments which are neither original nor the outcome of the author's research or creativity. The synthesis of existing facts and weaving them to propose new streams may be attributed to the author. The author has no claim or rights over the data, visuals and graphics used in this document. The material is sourced from the world wide web and expressly used for the sole purpose of explaining thoughts presented in this document. This presentation may be shared with anyone and disseminated or used for non-commercial or academic purposes. [shoumen@mit.edu](mailto:shoumen@mit.edu) ▪ [www.mdnpn.org](http://www.mdnpn.org)

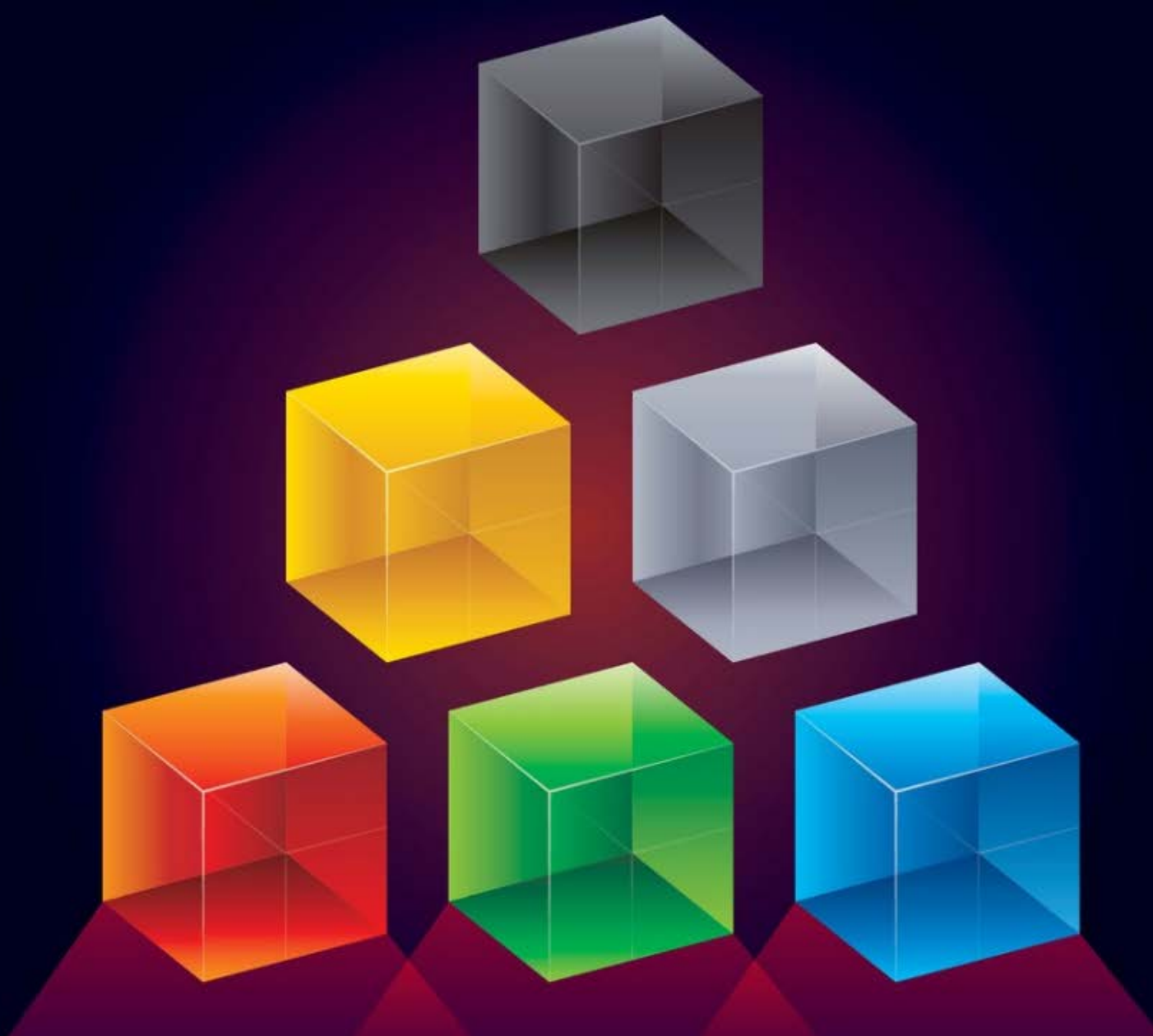

## Dr Shoumen Palit Austin Datta

MIT Auto-ID Labs and Research Affiliate, Department of Mechanical Engineering, Massachusetts Institute of Technology • [shoumen@mit.edu](mailto:shoumen@mit.edu)

Senior Scientist, MD PnP Lab, Medical Device Interoperability, Massachusetts General Hospital, Harvard Medical School • [www.mdnp.org](http://www.mdnp.org)